



buffet | tabletop | bar

GASTRONOMIE- UND SERVIERARTIKEL

FOOD SERVICE EQUIPMENT
EQUIPAMIENTOS PROFESIONALES
EQUIPEMENT PROFESSIONNEL

KATALOG NR 45
CATALOG NO 45
CATÁLOGO N° 45
CATALOGUE N° 45

2018

SINCE 1933

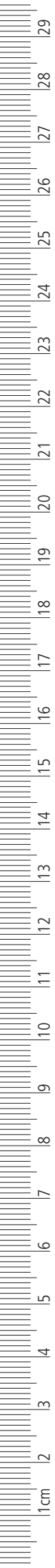

Assheuer + Pott GmbH & Co. KG

Talweg 11, 59846 Sundern, Germany
Telefon +49 (0) 29 33 / 97 35 - 0
Telefax +49 (0) 29 33 / 97 35 - 35 (Zentrale)
Telefax +49 (0) 29 33 / 97 35 - 34 (Export)
info@aps-germany.de

aps-germany.de



Standort Sundern / Sauerland
headquarter in Sundern / Sauerland



Buffetwelten
world of buffet



Buffet & Service



Buffet & Tabletop Melamin



Tabletop



Körbe
baskets
cestas
corbeilles



Chafing Dish,
GN Container & Transport



Bar & Café



Servier- & Küchenhelfer
serving items & kitchentools
herramientas de cocina
outils de cuisine



Hauben & Zubehör
covers & spare parts
campanas y piezas de repuesto
cloches et pièces de rechange



2018

Neuheiten

News

Novedades

Nouveautés



„ASIA+“ - Buffetwelten - S. 26 - 35



Getränkespender - Buffet & Service - S. 105



Brotstation - Buffet & Service - S. 119



„AQUARIS“ - Buffet & Tabletop Melamin - S. 167



„JADE“ - Buffet & Tabletop Melamin - S. 168



„ELEMENT“ - Tabletop - S. 250



„VINTAGE“ - Tabletop - S. 305



„PAPERBAGS“ - Körbe - S. 342



„URBAN“ - Körbe - S. 348



„MOSCOW MULE“ - Bar & Café - S. 414



Alle Neuheiten haben wir im Katalog mit dem „NEW“ - Logo gekennzeichnet.

Hemos marcado todas las novedades en este catálogo con el logotipo „NEW“.

We have marked all novelties in the catalogue with the logo „NEW“.

Nous avons marqué tous les nouveautés dans le catalogue avec le logo „NEW“.

APS-Quality Made in Germany since 1933

Gastronomie- und Servierartikel

food service equipment

equipamientos profesionales

équipement professionnel

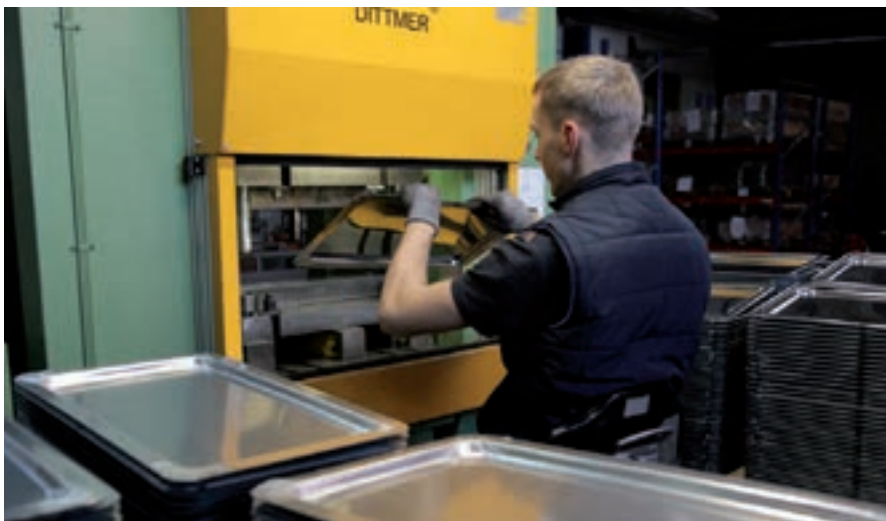

Tradition - seit 1933

APS zählt zu den bedeutendsten Anbietern rund um den gedeckten Tisch und das Buffet. Seit 1933 hat sich APS einen Namen in der Gastronomie, Hotellerie und Catering gemacht. Bereits in der vierten Generation produzieren wir u. a. an unserem Standort Sundern im Sauerland Servierartikel. Unser Erfolg setzt sich aus Zuverlässigkeit, Qualität und mutigen Produktentwicklungen zusammen. Ein professionelles Partnernetz sorgt für eine kompetente Beratung rund um den Globus.

Tradition - since 1933

APS is one of the most important suppliers of equipment around the table and the buffet. Since 1933, APS is well-known in the gastronomy, hotel industry and catering sector. We produce catering items, already in the fourth generation, also in our location in Sundern in the Sauerland. Our success consists of reliability, quality and courageous product development. A professional network of partners provides advice around the world.



Als inhabergeführtes Familienunternehmen in der 4. Generation legt APS viel Wert auf Kontinuität, Innovation und Vertrauen, v. a. gegenüber unseren internationalen Partnern.

As a family-run company in the 4th generation, we value continuity, innovation and trust in particular towards our international partners.

Como empresa familiar administrada en la 4ª generación ponemos mucho énfasis en la continuidad, la innovación y la confianza sobre todo hacia nuestros socios internacionales.

En tant qu'entreprise familiale gérée par la 4e génération, nous apprécions la continuité, l'innovation et la confiance surtout envers nos partenaires internationaux.



Seit 1933 fertigt und vertreibt APS vom sauerländischen Standort Sundern aus, professionelle Servierartikel in die ganze Welt. Bereits 1956 trifft man sich mit den internationalen Partnern auf der Frankfurter Messe.

Since 1933, APS manufactures and sells from the headquarter Sundern based in the Sauerland, professional serving products all over the world. Already in 1956 we met with international partners at the Fair in Frankfurt.

Desde 1933, APS fabrica y vende desde Sundern en el Sauerland, productos de equipamiento profesional a todo el mundo. Ya en 1956 se reúne con los socios internacionales en la Feria de Frankfurt.

Depuis 1933, APS fabrique et vend à partir du site in Sundern au Sauerland, des produits de service professionnel dans le monde entier. Déjà 1956 on rencontre les partenaires internationaux au Salon de Francfort.

Tradición - desde 1933

APS es uno de los proveedores más importantes alrededor del menaje para la mesa y el bufé. Desde 1933, APS ha sabido dar respuesta a las nuevas exigencias en el sector de la gastronomía, la hostelería y el catering. Producimos artículos para servir, ya en la cuarta generación, entre otros en nuestra sede en Sundern en el Sauerland. Nuestro éxito se compone de fiabilidad, calidad y el desarrollo de productos. Una red de socios profesionales proporciona un asesoramiento en todo el mundo.

Tradition - depuis 1933

APS est l'un des fournisseurs les plus importants autour de la table et le buffet. Depuis 1933, APS s'a fait un nom dans le restaurant, l'hôtel et la restauration. Déjà dans la quatrième génération, nous produisons des articles, entre autres, sur notre site à Sundern au Sauerland. Notre succès est composé de la fiabilité, la qualité et le développement de produits. Un réseau de partenaires professionnels fournit des conseils dans le monde entier.



Standort Sundern - Sauerland, Deutschland / headquarter Sundern - Sauerland, Germany

APS Showroom + Skylounge

Design Made in Germany

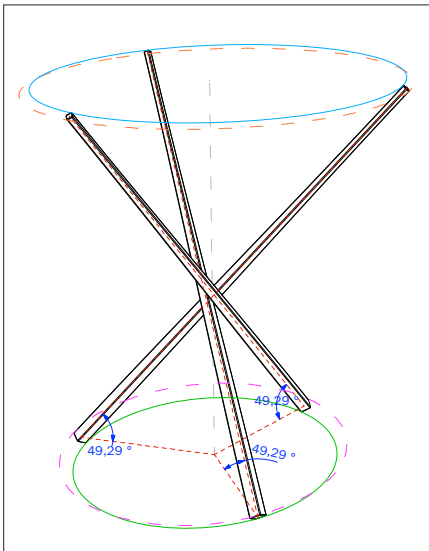

Die Tisch- und Buffetkultur wird mit den unverwechselbaren Produkten der Marke APS immer wieder neu definiert. Die Zusammenarbeit mit namhaften Designern trägt maßgeblich zum Erfolg bei.

The table and buffet culture is constantly being redefined with the distinctive products of the brand APS. The cooperation with well-known designers contributes significantly to the success.

La cultura de mesa y del buffet se están redefiniendo constantemente con los productos inconfundibles de la marca APS. La cooperación con diseñadores prestigiosos contribuye significativamente al éxito.

La culture de table et de buffet est constamment redéfinie avec les produits uniques de la marque APS. La coopération avec des designers bien connus contribue de manière significative au succès.

APS - Design made in Germany

Die Tisch- und Buffetkultur ist ständig in Bewegung. APS entwickelt exklusive Stilewelten und eröffnet nahezu unendlich viele Möglichkeiten, Speisen zu inszenieren. Ein professionelles Produktportfolio, das sich im Gastronomiealltag bewährt.

APS - Diseño fabricado en Alemania

La cultura de la mesa y el bufé está en constante movimiento. APS ha desarrollado estilos exclusivos y abre posibilidades casi infinitas a la presentación y decoración de alimentos. Una gama amplia de productos profesionales que se prueban diariamente en la gastronomía.

APS - Design made in Germany

Table and buffet culture is constantly on the move. APS develops exclusive styles and opens up almost endless possibilities for dining. A professional product portfolio that is proven in the everyday catering business.

APS - design made in Germany

La culture de la table et du buffet est constamment en mouvement. APS a développé des mondes de style exclusif et ouvre des possibilités presque infinies à la présentation et la décoration de la table et le buffet. Un portfolio de produits professionnels éprouvé dans la gastronomie de tous les jours.

Buffetwelten
world of buffet



25



35



37



50



59

Buffet & Service



63



99



125



134



162

Buffet & Tabletop
Melamin



169



182



194



226



243

Tabletop



253



257



291



311



319

Körbe
baskets
cestas
corbeilles



332



341



342



343



349

Chafing Dish,
GN Container & Transport



352



366



377



392



394

Bar & Café



405



409



413



416



452

Servier- & Küchenhelfer
serving items & kitchentools
herramientas de cocina
outils de cuisine



467



478



489



502



505

Hauben & Zubehör
covers & spare parts
campanas y piezas de repuesto
cloches et pièces de rechange



508



510



513



514



515





Buffetwelten

world of buffet

APS+
ASIA+
Frames
Superbox
Bridge
Sunday
Focus
Profi Line

APS+

Universal

Bowls
S. 13

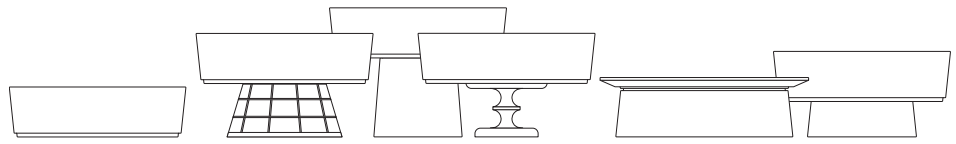

Antipasti

Flat Bowls
S. 16

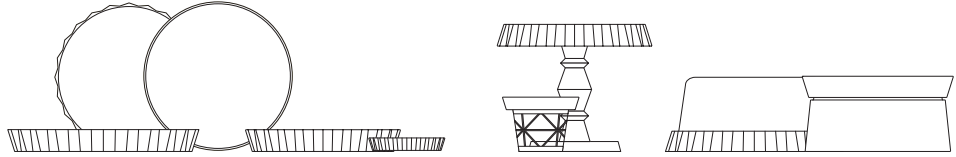

Bakery

Platters & Etagère
S. 17

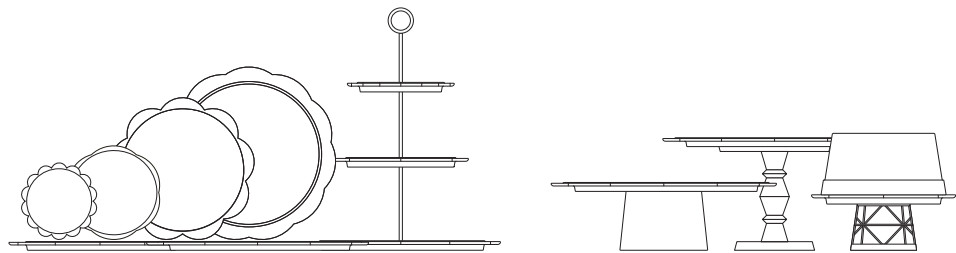

Lotus

Bowls & Platters
S. 18

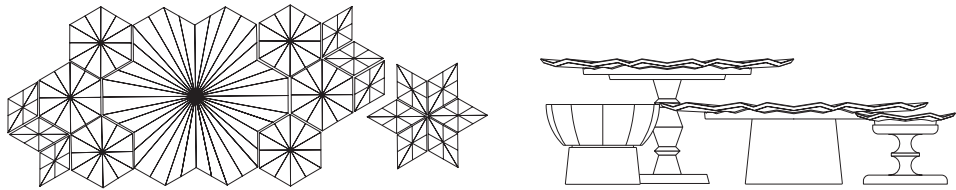

Tiles

Platters & Tray
S. 20

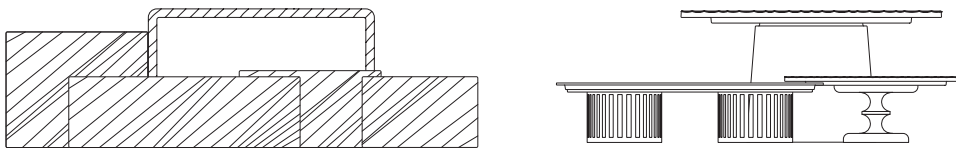

Baskets

Baskets & Riser
S. 22

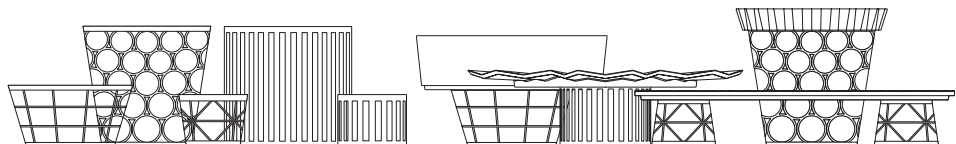

Wood

Platters & Stands
S. 24

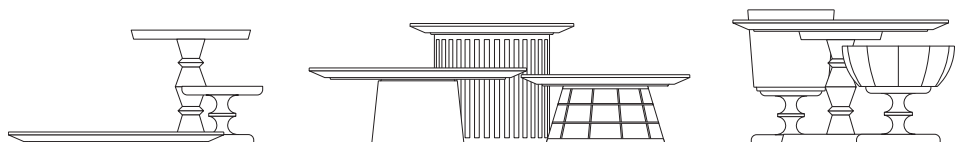

UNIVERSAL

APS+



+ Kompatibilität / compatibility / combinación / compatibilité

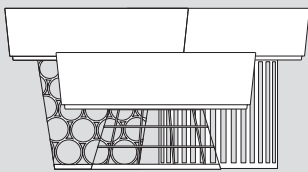

Baskets
risers

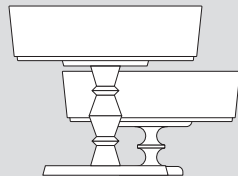

Wood
risers

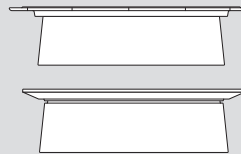

Bakery / Wood
plates

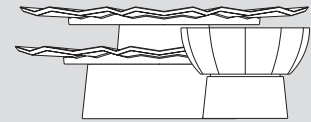

Lotus
bowls / plates



weiß; innen glänzend, außen matt
white; glossy on the inside, matt on the outside
blanco; interior brillante, exterior mate
blanc; intérieur brillant, extérieur mat



Holzdekor Ahorn & Farbe
maple wood decor & colour
textura de madera arce & color
aspect érable & couleur

bicolor
bicolour
bicolor
bicolore



Holzdekor Eiche dunkel & Farbe
oak wood decor & colour
textura de madera roble oscuro
aspect chêne foncé & couleur

bicolor
bicolour
bicolor
bicolore



Holzdekor Ahorn & cream

Holzdekor Eiche & cream

Holzdekor Ahorn & red

Holzdekor Eiche & red

Holzdekor Ahorn & green

Holzdekor Eiche & green

beige cream

brown cream



GN 1/4 Schale „UNIVERSAL“

GN 1/4 bowl
GN 1/4 cuenco
GN 1/4 bol



	cm	↑ cm	GN	litr.	Farbe / Colour
15116	26,5 x 16,2	7	1/4	1,5	
15117	26,5 x 16,2	9	1/4	2,5	



Schale, quadratisch „UNIVERSAL“

bowl, square
cuenco cuadrado
bol carré



	cm	↑ cm	ltr.	Farbe / Colour
15110	6,5 x 6,5	6	0,15	
15111	9 x 9	4	0,15	
15112	13 x 13	7	0,6	
15113	20 x 20	7	1,5	
15114	24 x 24	9	3,5	
15115	26,5 x 26,5	9	4	



Schale, rund „UNIVERSAL“

bowl, round
cuenco, redondo
bol rond



	Ø cm	↑ cm	ltr.	Farbe / Colour
15100	6,5	6	0,15	
15101	9,0	4	0,15	
15102	13,0	7	0,6	
15103	16,0	12	1,5	
15104	16,0	15	2,5	
15105	20,0	7	1,5	
15106	24,0	9	2,7	
15107	26,5	9	3	
15108	32,5	9	4	



GN 1/4 Schale „UNIVERSAL“

GN 1/4 bowl
GN 1/4 cuenco
GN 1/4 bol



	cm	↑ cm	GN	ltr.	Farbe / Colour
15219	26,5 x 16,2	7	1/4	1,5	
15220	26,5 x 16,2	9	1/4	2,5	
15234	26,5 x 16,2	7	1/4	1,5	
15235	26,5 x 16,2	9	1/4	2,5	



Schale, quadratisch „UNIVERSAL“

bowl, square
bol cuadrado
plat creux carré



	cm	↑ cm	ltr.	Farbe / Colour
15215	13 x 13	7	0,6	
15216	20 x 20	7	1,5	
15217	24 x 24	9	3,5	
15218	26,5 x 26,5	9	4	
15232	20 x 20	7	1,5	
15233	26,5 x 26,5	9	4	



Schale, rund „UNIVERSAL“

bowl, round
cuenco, redondo
bol rond



	Ø cm	↑ cm	ltr.	Farbe / Colour
15210	13,0	7	0,6	
15211	20,0	7	1,5	
15212	24,0	9	2,7	
15213	26,5	9	3	
15214	32,5	9	4	
15230	20,0	7	1,5	
15231	32,5	9	4	



Schale „UNIVERSAL“

bowl
cuenco
bol



	Ø cm	↑ cm	ltr.	Farbe / Colour
15200	6,5	6	0,15	
15201	9	4	0,15	
15202	16	12	1,5	
15203	16	15	2,5	



Schale „UNIVERSAL“

bowl
cuenco
bol



	cm	↑ cm	ltr.	Farbe / Colour
15204	6,5 x 6,5	6	0,15	
15205	9 x 9	4	0,15	



Deckel „UNIVERSAL“

cover
tapa
couvercle



glasklar, mit Löffelaussparung
transparent, with notched for spoons
plástico, con espacio para la cuchara
transparent, avec encoche pour la cuillère

	cm	↑ cm	GN
15348	26,5 x 16,2	1,5	1/4
	cm	↑ cm	
15345	20 x 20	1,5	
15346	24 x 24	1,5	
15347	26,5 x 26,5	1,5	
	Ø cm	↑ cm	
15340	16	1,5	
15341	20	1,5	
15342	24	1,5	
15343	26,5	1,5	
15344	32,5	1,5	

ANTI PASTI



+ Kompatibilität / compatibility / combinación / compatibilit 

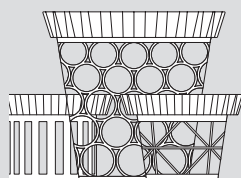

Baskets
risers



Cover
seal

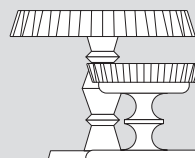

Wood
risers

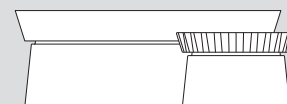

Bowls
risers



Schale „PLISSEE“

bowl
cuenco
bol



	∅ cm	↑ cm	Farbe / Colour
15140	14,5	2,5	White
15141	25,0	3,5	White
15142	35,0	4,0	White



Schale

bowl
cuenco
bol



	∅ cm	↑ cm	Farbe / Colour
15135	14,5	2,5	White
15136	25,0	3,5	White
15137	35,0	4,0	White



Schale

bowl
cuenco
bol



	∅ cm	↑ cm	Farbe / Colour
15270	14,5	2,5	White
15271	25,0	3,5	White
15272	35,0	4,0	White

BAKERY

APS+



+ Kompatibilität / compatibility / combinación / compatibilité

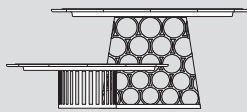

Baskets
risers

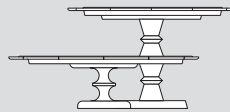

Wood
risers

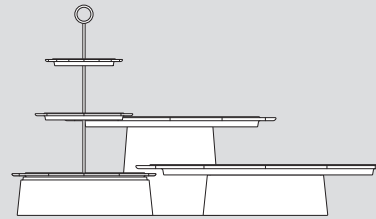

Universal
risers



Tablett „BAKERY“

tray
bandeja
plateau



	Ø cm	↑ cm	Farbe / Colour
15130	18,5	1,5	
15131	23,5	1,5	
15132	35,0	1,5	
15133	42,5	1,5	



Etagère „BAKERY“

etagère
expositor
présentoir



	Ø cm	↑ cm	Farbe / Colour
15160	35 / 23,5 / 18,5	40	

LOTUS



+ Kompatibilität / compatibility / combinación / compatibilité

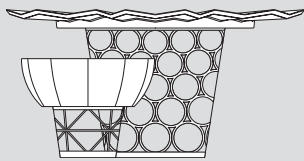

Baskets
risers

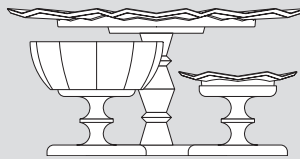

Wood
risers

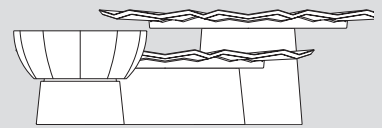

Universal
risers



Blattschale large „LOTUS“
leaf large
fuente en forma de hoja
plat feuille



	Ø cm	↑ cm	Farbe / Colour
15152	46,5	2,5	
15257	46,5	2,5	
15263	46,5	2,5	



Blattschale medium „LOTUS“
leaf bowl medium
fuente en forma de hoja
plat feuille



	Ø cm	↑ cm	Farbe / Colour
15151	17,5	2,5	
15259	17,5	2,5	
15256	17,5	2,5	
15262	17,5	2,5	



Blattschale small „LOTUS“

leaf small
fuente en forma de hoja
plat feuille



	cm	↑ cm	Farbe / Colour
15150	15 x 8,5	2,5	
15258	15 x 8,5	2,5	
15255	15 x 8,5	2,5	
15261	15 x 8,5	2,5	



Schale Water Lily „LOTUS“

leaf
fuente en forma de hoja
plat feuille



	Ø cm	↑ cm	ltr.	Farbe / Colour
15165	8,5	4	0,1	
15166	13	6	0,3	
15167	20	7	1,25	



Schale Water Lily „LOTUS“

leaf
fuente en forma de hoja
plat feuille



	Ø cm	↑ cm	ltr.	Farbe / Colour
15206	8,5	4	0,1	
15207	13	6	0,3	
15208	20	7	1,25	

TILES



+ Kompatibilität / compatibility / combinación / compatibilité

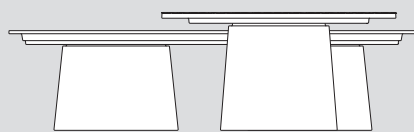

Bowls
risers

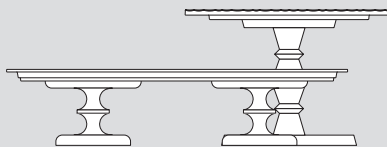

Wood
risers

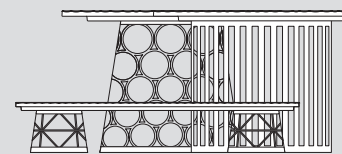

Baskets
risers



GN 1/1 Tablett „TILES“

GN 1/1 tray
GN 1/1 bandeja
GN 1/1 plateau



	cm	↑ cm	GN	Farbe / Colour
15120	53,0 x 32,5	2	1/1	White
15236	53,0 x 32,5	2	1/1	Black

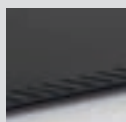



GN Tablett „TILES“

GN tray
GN bandeja
GN plateau



	cm	↑ cm	GN	Farbe / Colour
15125	26,5 x 16,2	1,5	1/4	
15126	35,5 x 17,6	1,5	1/3	
15128	32,5 x 26,5	1,5	1/2	
15127	53,0 x 16,2	1,5	2/4	

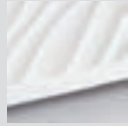

GN Tablett „TILES“

GN tray
GN bandeja
GN plateau



	cm	↑ cm	GN	Farbe / Colour
15250	26,5 x 16,2	1,5	1/4	
15251	32,5 x 17,5	1,5	1/3	
15253	32,5 x 26,5	1,5	1/2	
15252	53,0 x 16,2	1,5	2/4	



GN Tablett „TILES“

GN tray
GN bandeja
GN plateau



	cm	↑ cm	GN	Farbe / Colour
15221	26,5 x 16,2	1,5	1/4	
15222	32,5 x 17,6	1,5	1/3	
15224	32,5 x 26,5	1,5	1/2	
15223	53,0 x 16,2	1,5	2/4	

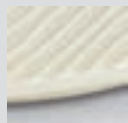

GN Tablett „TILES“

GN tray
GN bandeja
GN plateau



	cm	↑ cm	GN	Farbe / Colour
15225	26,5 x 16,2	1,5	1/4	
15226	32,5 x 17,5	1,5	1/3	
15228	32,5 x 26,5	1,5	1/2	
15227	53,0 x 16,2	1,5	2/4	

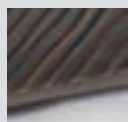

BASKET



+ Kompatibilität / compatibility / combinación / compatibilité

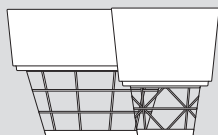

Universal
bowls

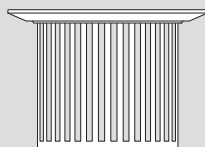

Wood
plates

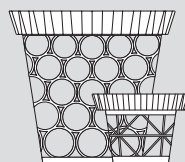

Antipasti
flat bowls

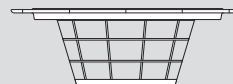

Tiles
plates

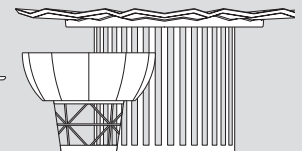

Lotus
plates



Korb / Ständer „BASKET“

basket / riser
cesta / soporte
corbeille / support



	Ø cm	↑ cm	Farbe / Colour
15326	21 / 15	21	■



Korb / Ständer „BASKET“

basket / riser
cesta / soport
corbeille / support



	Ø cm	↑ cm	Farbe / Colour
15321	21 / 15	11	
15325	21 / 15	11	
15323	21 / 15	11	



Korb / Ständer „BASKET“

basket / riser
cesta / soport
corbeille / support



	Ø cm	↑ cm	Farbe / Colour
15320	10,5 / 8	8	
15324	10,5 / 8	8	
15322	10,5 / 8	8	



Korb / Ständer „BASKET“

basket / riser
cesta / soport
corbeille / support



Chrom poliert
polished chrome
color plata brillante
chrome poli

	Ø cm	↑ cm	Farbe / Colour
15331	15	10,5	
15332	21	20	



Korb / Ständer „BASKET“

basket / riser
cesta / soport
corbeille / support



Gold, gebürstet
brushed gold
dorado cepillado
doré brossé

	Ø cm	↑ cm	Farbe / Colour
15334	15	10,5	
15335	21	20	

WOOD

+ Kompatibilität / compatibility / combinación / compatibilité

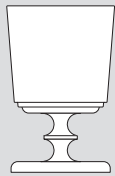

Universal
bowls

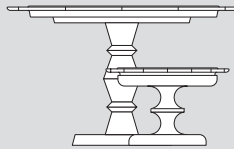

Tiles
plates

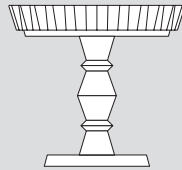

Antipasti
flat bowls

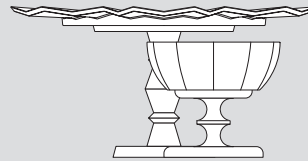

Lotus
plates / bowls

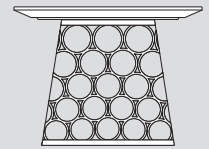

Baskets
risers



Tablett „WOOD“

tray
bandeja
plateau



	Ø cm	↑ cm	Farbe / Colour
15300	30,0	2	
15302	38,5	2	



Tablett „WOOD“

tray
bandeja
plateau



	Ø cm	↑ cm	Farbe / Colour
15301	30,0	2	
15303	38,5	2	



Ständer „WOOD“

stand
soporte
support



	Ø cm	↑ cm	Farbe / Colour
15310	15 / 11,5	10,5	
15311	15 / 11,5	10,5	



Ständer „WOOD“

stand
soporte
support



	Ø cm	↑ cm	Farbe / Colour
15312	21 / 15	20	
15313	21 / 15	20	

Hauben

APS+



Frischhalte-Haube

cover
campana
cloche bombée



glasklar, Griff verchromt, schwere, stabile Ausführung
transparent, chrome knob, heavy stable quality
transparente, asa cromada, alta estabilidad
transparente, anse chromée, très stable

	Ø cm	↑ cm	✱ mm	fits to
15350	16,5	10	3	15130
15351	20,5	10	3	15141, 15136, 15271, 15131



Frischhalte-Haube

cover
campana
cloche



	Ø cm	↑ cm	fits to
06512	30	11,5	15142, 15137, 15272, 15132
06517	33	12,5	15133, 15302, 15303



Rolltophaube

rolltop cover
campana abatible
cloche basculante



glasklarer Kunststoff, leichtgängig auf- und zuklappen 90°
solid quality, to be opened 90°
plástico transparente de alta calidad, apertura a 90°
plastique transparent résistant, ouverture 90°

	Ø cm	↑ cm	fits to
18388	38	20	15133, 15302, 15303

ASIA+



Nahezu alle ASIA+ Produkte verfügen über ein System von Ringen und Radien und können dadurch stand- und rutschfest miteinander kombiniert werden. So können beispielsweise alle Schalen auch als Riser / Aufsteller für unterschiedlichste weitere ASIA+ Produkte verwendet werden.

Nearly all ASIA+ products feature a system of rings and radii that allow them to be combined with each other in a stable manner. For example, all bowls can be used as risers for a wide range of other ASIA+ products. The same applies to the baskets.

Casi todos los productos de ASIA+ disponen de un sistema de anillos y radios que permiten su combinación entre sí con una estabilidad perfecta. Así por ejemplo, todos los cuencos se pueden utilizar también como pedestales para los productos más diversos de ASIA+. Y lo mismo ocurre con las cestas.

Presque tous les produits ASIA+ sont munis d'un système d'anneaux et de rayons, ce qui permet de les combiner entre eux de façon stable. Ainsi, tous les bols et saladiers servent aussi de rehausseurs pour les produits ASIA+ les plus divers. Il en va de même des corbeilles.



Tablett tray

Schale bowl



15523 / 15525
Tablett / tray

15524 / 15526
Zwischenplatte

ASIA+



Tablett „ASIA PLUS“

tray
bandeja
plateau



	Ø cm	↑ cm	Farbe / Colour
15530	30,0	3	White
15531	38,0	3	White
15532	48,5	3	White
15533	30,0	3	Black/Red
15534	38,0	3	Black/Red
15535	48,5	3	Black/Red



Tablett / Platte „ASIA PLUS“

tray
bandeja
plateau



	Ø cm	↑ cm	
15523	38,0	2,5	einfach gefälzt / single seamed pliegue sencillo / plié une seule fois
15525	48,5	2,5	einfach gefälzt / single seamed pliegue sencillo / plié une seule fois



Zwischenplatte „ASIA PLUS“

intermediate plate
bandeja intermedia
plateau intermédiaire



	Ø cm	↑ cm	
15524	38,0	2,5	doppelt gefälzt / double seamed pliegue doble / plié en double
15526	48,5	2,5	doppelt gefälzt / double seamed pliegue doble / plié en double



Buffetständer „ASIA PLUS“

buffet stand
soporte para bufé
présentoir buffet



	Ø cm	↑ cm	Farbe / Colour
15515	38,0	16,5	Grey
15516	38,0	27,0	Grey
15517	48,5	16,5	Grey
15518	48,5	27,0	Grey
15519	38,0	16,5	Black
15520	38,0	27,0	Black
15521	48,5	16,5	Black
15522	48,5	27,0	Black

ASIA+



GN Tablett „ASIA PLUS“

GN tray
GN bandeja
GN plateau



	cm	↑ cm	GN	Farbe / Colour
15449	53,0 x 32,5	3	1/1	White
15450	32,5 x 26,5	3	1/2	White
15451	32,5 x 17,6	3	1/3	White
15452	26,5 x 16,2	3	1/4	White
15453	35,4 x 32,5	3	2/3	White
15454	53,0 x 16,2	3	2/4	White
15455	53,0 x 32,5	3	1/1	Black/Red
15456	32,5 x 26,5	3	1/2	Black/Red
15457	32,5 x 17,6	3	1/3	Black/Red
15458	26,5 x 16,2	3	1/4	Black/Red
15459	35,4 x 32,5	3	2/3	Black/Red
15460	53,0 x 16,2	3	2/4	Black/Red



Antirutschmatte „ASIA PLUS“

non slip mat
esterilla
tapis



	cm	fits to
15497	51,0 x 31,0	15449, 15455
15499	31,0 x 25,5	15450, 15456



Antirutschmatte „ASIA PLUS“

non slip mat
esterilla
tapis



	cm	fits to
15498	51,0 x 31,0	15449, 15455
15500	31,0 x 25,5	15450, 15456

ASIA+

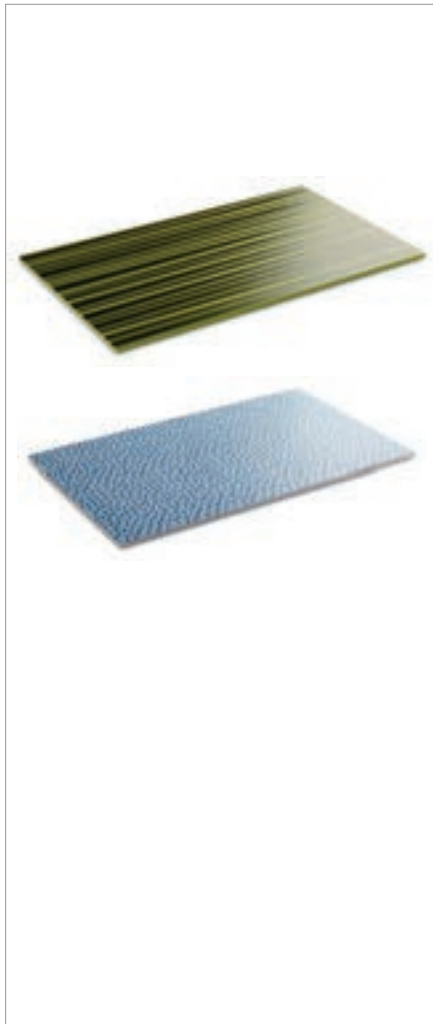

GN Tablett „ASIA PLUS“

GN tray
GN bandeja
GN plateau



	cm	↑ cm	GN	Farbe / Colour
15439	53,0 x 32,5	1,5	1/1	
15440	32,5 x 26,5	1,5	1/2	
15441	32,5 x 17,6	1,5	1/3	
15442	26,5 x 16,2	1,5	1/4	
15443	53,0 x 16,2	1,5	2/4	
15444	53,0 x 32,5	1,5	1/1	
15445	32,5 x 26,5	1,5	1/2	
15446	32,5 x 17,6	1,5	1/3	
15447	26,5 x 16,2	1,5	1/4	
15448	53,0 x 16,2	1,5	2/4	

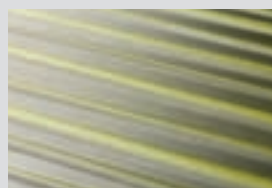

GN 1/1	GN 1/2	GN 1/4	GN 2/4
	GN 1/2	GN 1/4	
GN 1/3	GN 1/3	GN 1/3	

ASIA+



Schale „ASIA PLUS“

bowl
cuenco
bol



	Ø cm	↑ cm	ltr.	Farbe / Colour
15400	7,5	3,5	0,06	White
15401	9,5	4,5	0,13	White
15402	13	5,5	0,35	White
15403	16	7	0,60	White
15404	20	8	1,10	White
15405	24	9,5	2,20	White
15406	26,5	11	3,00	White
15407	32,5	12,5	5,40	White
15408	7,5	3,5	0,06	White/Blue
15409	9,5	4,5	0,13	White/Blue
15410	13	5,5	0,35	White/Blue
15411	16	7	0,60	White/Blue
15412	20	8	1,10	White/Blue
15413	24	9,5	2,20	White/Blue
15414	26,5	11	3,00	White/Blue
15415	32,5	12,5	5,40	White/Blue
15416	7,5	3,5	0,06	Black/Red
15417	9,5	4,5	0,13	Black/Red
15418	13	5,5	0,35	Black/Red
15419	16	7	0,60	Black/Red
15420	20	8	1,10	Black/Red
15421	24	9,5	2,20	Black/Red
15422	26,5	11	3,00	Black/Red
15423	32,5	12,5	5,40	Black/Red



Deckel „UNIVERSAL“ mit Löffelaussparung

cover with notched for spoons
tapa con espacio para la cuchara
couvercle avec encoche pour la cuillère



	Ø cm	↑ cm	fits to
15340	16	1,5	15403, 15411, 15419
15341	20	1,5	15404, 15412, 15420
15342	24	1,5	15405, 15413, 15421
15343	26,5	1,5	15406, 15414, 15422
15344	32,5	1,5	15407, 15415, 15423

ASIA+

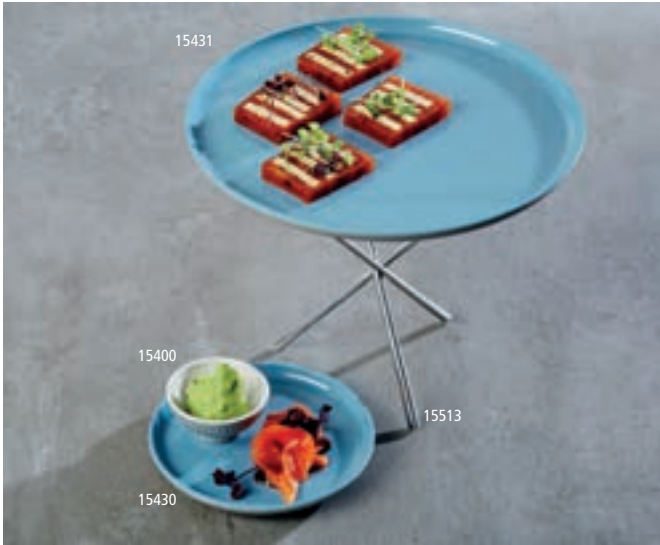

Teller „ASIA PLUS“

plate
plato
assiette



	Ø cm	↑ cm	Farbe / Colour
15424	11	2	
15425	16	2	
15426	19,5	2	
15427	24	2	
15428	28	2	

	Ø cm	↑ cm	Farbe / Colour
15429	11	2	
15430	16	2	
15431	19,5	2	
15432	24	2	
15433	28	2	

	Ø cm	↑ cm	Farbe / Colour
15434	11	2	
15435	16	2	
15436	19,5	2	
15437	24	2	
15438	28	2	



ASIA+



ASIA+

Bento Box „ASIA PLUS“



	Ø cm	↑ cm	ltr.	Farbe / Colour
15461	7,5	3	0,04	
15462	7,5	6,5	0,13	
15463	15,5	3	0,13	
15464	15,5	6,5	0,60	
15465	23	3	0,40	
15466	23	6,5	1,60	



	Ø cm	↑ cm	ltr.	Farbe / Colour
15467	7,5	3	0,04	
15468	7,5	6,5	0,13	
15469	15,5	3	0,13	
15470	15,5	6,5	0,60	
15471	23	3	0,40	
15472	23	6,5	1,60	

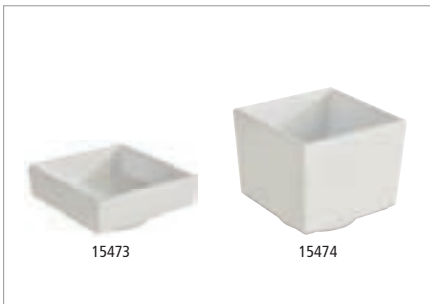

	cm	↑ cm	ltr.	Farbe / Colour
15473	7,5 x 7,5	3	0,05	
15474	7,5 x 7,5	6,5	0,16	
15479	15,5 x 15,5	3	0,19	
15480	15,5 x 15,5	6,5	0,85	
15481	23 x 23	3	0,45	
15482	23 x 23	6,5	2,00	



	cm	↑ cm	ltr.	Farbe / Colour
15485	7,5 x 7,5	3	0,05	
15486	7,5 x 7,5	6,5	0,16	
15491	15,5 x 15,5	3	0,19	
15492	15,5 x 15,5	6,5	0,85	
15493	23 x 23	3	0,45	
15494	23 x 23	6,5	2,00	



	cm	↑ cm	ltr.	Farbe / Colour
15475	15,5 x 7,5	3	0,10	
15477	15,5 x 9,5	3	0,15	
15476	15,5 x 7,5	6,5	0,40	
15478	15,5 x 9,5	6,5	0,50	
15483	25 x 15,5	3	0,30	
15484	25 x 15,5	6,5	1,40	



	cm	↑ cm	ltr.	Farbe / Colour
15487	15,5 x 7,5	3	0,10	
15488	15,5 x 7,5	6,5	0,40	
15489	15,5 x 9,5	3	0,15	
15490	15,5 x 9,5	6,5	0,50	
15495	25 x 15,5	3	0,30	
15496	25 x 15,5	6,5	1,40	

ASIA+



ASIA+



Buffetständer „ASIA PLUS“

buffet stand
soporte para bufé
présentoir buffet



	Ø cm	↑ cm	Farbe / Colour
15515	38,0	16,5	Grey
15516	38,0	27,0	Grey
15517	48,5	16,5	Grey
15518	48,5	27,0	Grey
15519	38,0	16,5	Black
15520	38,0	27,0	Black
15521	48,5	16,5	Black
15522	48,5	27,0	Black



GN Buffetständer „ASIA PLUS“

GN buffet stand
GN soporte para bufé
GN présentoir buffet



	cm	GN	Farbe / Colour
15501	53,0 x 32,5 / 53,0 x 16,2	1/1 / 2/4	Grey
15502	32,5 x 26,5 / 26,5 x 16,2	1/2 / 1/4	Grey
15503	32,5 x 17,5 / 35,4 x 32,5	1/3 / 2/3	Grey
15504	53,0 x 32,5 / 53,0 x 16,2	1/1 / 2/4	Black
15505	32,5 x 26,5 / 26,5 x 16,2	1/2 / 1/4	Black
15506	32,5 x 17,5 / 35,4 x 32,5	1/3 / 2/3	Black

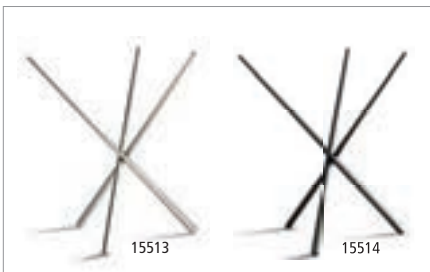

Buffetständer „ASIA PLUS“

buffet stand
soporte para bufé
présentoir buffet



	Ø cm	↑ cm	Farbe / Colour
15513	20,5 / 16,5	20	stainless steel
15514	20,5 / 16,5	20	Black



Buffetständer / -korb „ASIA PLUS“

buffet stand / basket
soporte para bufé / cestas
présentoir buffet / corbeilles



	Ø cm	↑ cm	Farbe / Colour
15507	15	10,5	Grey
15510	15	10,5	Black

	Ø cm	↑ cm	Farbe / Colour
15508	21	10,5	Grey
15511	21	10,5	Black

	Ø cm	↑ cm	Farbe / Colour
15509	21	20	Grey
15512	21	20	Black

FRAMES



Die reduzierte, archetypische Formsprache von FRAMES nimmt sich elegant zurück und lässt damit viel Raum für die Inszenierung der Buffet-Speisen. Ein scheinbarer Widerspruch löst sich auf: das Design ist zeitgemäß und zeitlos zugleich.

Design in detail – The classic minimalist visual style of FRAMES is elegantly understated, leaving plenty of potential for creating appealing buffet arrangements. Its design transcends what at first seems to be an irreconcilable paradox, being at once both timeless and highly contemporary.

Die Grundidee von FRAMES ist einfach: köstlichen Speisen einen attraktiven Rahmen geben. Und das ist durchaus wörtlich zu verstehen. Wie hochwertige Rahmungen eines Bildes sind die Edelstahlplatten des Buffetsystems gestaltet. Gleichzeitig erfüllt FRAMES sämtliche Anforderungen des modernen gastronomischen Alltags. Die Funktionalität der Produkte war bei der Design-Entwicklung ein zentraler Gedanke.

The basic idea behind FRAMES is a simple one: framing delicious food in an attractive setting. It's a concept we've taken literally to create the stainless steel platters in our new buffet range, platters which work in the same way as high-quality picture frames. At the same time, FRAMES meets all the requirements of contemporary kitchens. Indeed, functionality was a core consideration throughout the design and development stages.



Bildschön sind die Edelstahlplatten von FRAMES, die den Speisen des Buffets einen würdigen Rahmen verleihen sollen.

The attractive FRAMES stainless steel platters provide buffet food with a setting that truly does it justice.

Die Basis-Sets der Cool Plates sind individuell erweiterbar und lassen sich jederzeit individuell einsetzen. Die gleiche Basis kann mit dem richtigen Aufsatz als Kühlplatte, Schneidebrett oder Schalenhalter genutzt werden.

The Cool Plate base sets can be expanded to meet your individual requirements and arranged in a host of different ways. Depending on the cover panel, a single base can serve as a cool plate, a chopping board or a bowl holder.

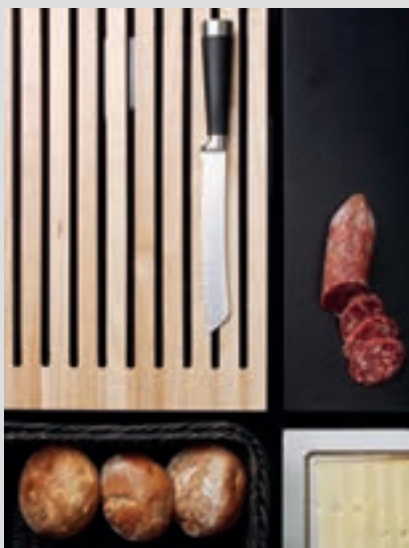

Die Systemelemente sind modular aufgebaut und deshalb multifunktional. Es können verschiedene Module aufgesetzt und unterschiedlich kombiniert bzw. genutzt werden.

The system elements feature a modular construction, making them extremely versatile. Various modules can be mixed and matched for a range of different applications.





Kühltablets SET 1

cooling plates
bandejas refrigeradas
plateaux réfrigérés



GN 1/1 Basiselement, GN 1/1 Edelstahl Tablett 18/10, Kühlakku
GN 1/1 base element, GN 1/1 stainless steel platter 18/10, cooler
elemento básico GN 1/1, bandeja GN 1/1 de acero inoxidable 18/10, acumulador de frío
élément de base GN 1/1, plateau GN 1/1 inox 18/10, accumulateur de froid

	cm	↑ cm	GN	Farbe / Colour	
12940	53,0 x 32,5	8,5	1/1		stainless steel
14940	53,0 x 32,5	8,5	1/1		wenge wood
13940	53,0 x 32,5	8,5	1/1		ahorn wood



Kühltablets SET 2

cooling plates
bandejas refrigeradas
plateaux réfrigérés



GN 1/1 Basiselement, GN 1/1 Edelstahl Tablett 18/10, Rolltop-Haube, Kühlakku
GN 1/1 base element, GN 1/1 stainless steel platter, rolltop cover, cooler
elemento básico GN 1/1, bandeja GN 1/1 de acero inoxidable 18/10, campana rolltop, acumulador de frío
élément de base GN 1/1, plateau GN 1/1 inox 18/10, cloche rolltop, accumulateur de froid

	cm	↑ cm	GN	Farbe / Colour	
12941	53,0 x 32,5	27,5	1/1		stainless steel
14941	53,0 x 32,5	27,5	1/1		wenge wood
13941	53,0 x 32,5	27,5	1/1		ahorn wood



Kühltablets SET 3

cooling plates
bandejas refrigeradas
plateaux réfrigérés



GN 1/1 Basiselement, 2 x GN 1/2 Edelstahl Tablett 18/10, Kühlakku
GN 1/1 base element, 2 x GN 1/2 stainless steel platters 18/10, cooler
elemento básico GN 1/1, 2 x bandeja GN 1/1 de acero inoxidable 18/10, acumulador de frío
élément de base GN 1/1, 2 x plateau GN 1/1 inox 18/10, accumulateur de froid

	cm	↑ cm	GN	Farbe / Colour	
12942	53,0 x 32,5	8,5	1/1		stainless steel
14942	53,0 x 32,5	8,5	1/1		wenge wood
13942	53,0 x 32,5	8,5	1/1		ahorn wood

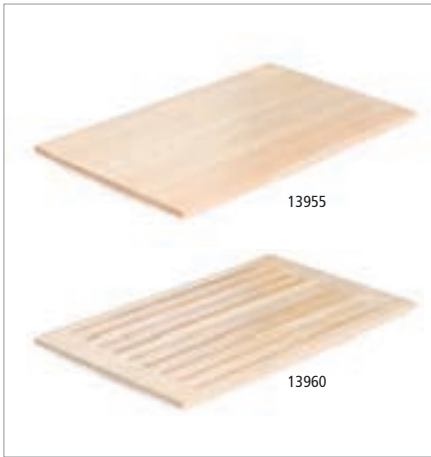

Schneidebrett

Chopping Board
tabla para cortar
planche à découper



Ahorn, massiv
ahorn wood, solid
madera de arce, masivo
bois d'érable, massif

	cm	GN	
13955	53,0 x 32,5	1/1	
13960	53,0 x 32,5	1/1	gerillt



Schneidebrett

Chopping Board
tabla para cortar
planche à découper



	cm	GN
17910	53,0 x 32,5	1/1



GN 1/1 Schalenhalter

GN 1/1 bowl module
GN 1/1 módulo para cuencos
GN 1/1 module pour bols



mit 5 Löchern (je Ø 13,2 cm)
with five holes (each Ø 13,2 cm)
con 5 agujeros (de ø 13,2 cm)
avec 5 trous (chacun de ø 13,2 cm)

	cm	GN	Farbe / Colour
14950	53,0 x 32,5	1/1	wenge wood
13950	53,0 x 32,5	1/1	ahorn wood



GN 1/1 Schalenhalter Set

GN 1/1 bowl module set
GN 1/1 módulo para cuencos
GN 1/1 module pour bols



mit 5 weißen Melaminschalen Ø 14 cm
with 5 white melamine bowls Ø 14 cm
con 5 cuencos blancos de melamina ø 14 cm
avec 5 bols blancs en melamine ø 14 cm

	cm	GN	Farbe / Colour
14951	53,0 x 32,5	1/1	wenge wood
13951	53,0 x 32,5	1/1	ahorn wood



GN 1/1 Schalenhalter Set

GN 1/1 bowl module set
GN 1/1 módulo para cuencos
GN 1/1 module pour bols



mit 5 weißen Melaminschalen und 5 Deckeln Ø 14 cm
with 5 melamine bowls and 5 lids Ø 14 cm
con 5 cuencos blancos de melamina y 5 tapas ø 14 cm
avec 5 bols blancs en melamine et 5 couvercles ø 14 cm

	cm	GN	Farbe / Colour
14952	53,0 x 32,5	1/1	wenge wood
13952	53,0 x 32,5	1/1	ahorn wood



GN Edelstahl Tablett „FRAMES“

GN stainless steel platter
GN bandeja
GN plateau



	cm	GN
11119	53,0 x 32,5	1/1
11118	32,5 x 26,5	1/2



GN Tablett „FRAMES“

GN tray
GN bandeja
GN plateau



	cm	↑ cm	GN
84046	53,0 x 32,5	2	1/1
84047	32,5 x 26,5	2	1/2
84048	32,5 x 17,6	2	1/3



GN 1/1 Rolltop-Haube

GN 1/1 rolltop cover
GN 1/1 campana abatible
GN 1/1 cloche basculante



	cm	↑ cm	GN
11018	53,0 x 32,5	17	1/1



Kühlakku

cooler
acumulador de frío
accumulateur de froid



	cm
10782	41 x 21



GN Polystyrolwanne

GN polystyrene tray
GN bandeja poliestireno
GN plateau polystyrène



	cm
17922	53,0 x 32,5



Bowl Board L Set 1



6-teilig: Basiselement, Kunststoffwanne, Abdeckplatte für 3 Schalen (Ø 23 cm), 3 Melamin-schalen (weiß)

6 pcs.: base element, polystyrene tray L, cover panel to hold 3 bowls (ø 23 cm), 3 melamine bowls (white)

set de 6 piezas: elemento básico, bandeja de poliestireno, tapa de cubierta para 3 cuencos (ø 23 cm), 3 cuencos de melamina (en blanco)

set de 6 pièces: élément de base, plateau de polystyrène, couvercle pour 3 bols (ø 23 cm), 3 bols en melamine (en blanc)

	cm	↑ cm	Farbe / Colour	
14935	79,5 x 26,5	8,5		wenge wood
13935	79,5 x 26,5	8,5		ahorn wood



Bowl Board L Set 2



9-teilig: Basiselement, Kunststoffwanne, Abdeckplatte für 3 Schalen (ø 23 cm), 3 Melamin-schalen (weiß), 3 Deckel

9 pcs.: base element, polystyrene tray L, cover panel to hold 3 bowls (ø 23 cm), 3 melamine bowls (white), 3 lids

set de 6 piezas: elemento básico, bandeja de poliestireno, tapa de cubierta para 3 cuencos (ø 23 cm), 3 cuencos de melamina (en blanco), 3 tapas

set de 6 pièces: élément de base, plateau de polystyrène, couvercle pour 3 bols (ø 23 cm), 3 bols en melamine (en blanc), 3 couvercles

	cm	↑ cm	Farbe / Colour	
14936	79,5 x 26,5	8,5		wenge wood
13936	79,5 x 26,5	8,5		ahorn wood



Bowl Board S Set 1



6-teilig: Basiselement, Kunststoffwanne, Abdeckplatte für 3 Schalen (ø 14 cm), 3 Melamin-schalen (weiß)

6 pcs.: base element, polystyrene tray L, cover panel to hold 3 bowls (ø 14 cm), 3 melamine bowls (white)

set de 6 piezas: elemento básico, bandeja de poliestireno, tapa de cubierta para 3 cuencos (ø 14 cm), 3 cuencos de melamina (en blanco)

set de 6 pièces: élément de base, plateau de polystyrène, couvercle pour 3 bols (ø 14 cm), 3 bols en melamine (en blanc)

	cm	↑ cm	Farbe / Colour	
14930	53,0 x 17,6	8,5		wenge wood
13930	53,0 x 17,6	8,5		ahorn wood



Bowl Board S Set 2

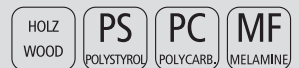

9-teilig: Basiselement, Kunststoffwanne, Abdeckplatte für 3 Schalen (Ø 14 cm), 3 Melamin-schalen (weiß), 3 Deckel

9 pcs.: base element, polystyrene tray L, cover panel to hold 3 bowls (Ø 14 cm), 3 melamine bowls (white), 3 lids

	cm	↑ cm	Farbe / Colour	
14931	53,0 x 17,6	8,5		wenge wood
13931	53,0 x 17,6	8,5		ahorn wood



Polystyrolwanne

polystyrene tray
bandeja de poliestireno
plateau de polystyrène



cm

17921	79,5 x 26,5
17920	53 x 17,6



Buffetleiter Set

bowl stand set
set dispensador en escalera
set présentoir buffet en escalier



14-teilig: Buffetleiter für 5 Schalen (ø 23cm): 5 Melaminschalen (weiß) mit 5 Deckeln, 2 Ringe (doppelt), 1 Ring (einzeln)

14 pcs.: bowl stand for 5 bowls (ø 23 cm): 5 melamine bowls (white) with 5 lids, 2 rings (double), 1 ring (single)

set de 14 piezas: dispensador en escalera para 5 cuencos (ø 23 cm): 5 cuencos de melamina (en blanco) con 5 tapas, 2 aros (doble), 1 aro (sencillo)

set de 14 pièces: présentoir buffet en escalier pour 5 bols (ø 23 cm): 5 bols en melamine (en blanc) avec 5 couvercles, 2 cercles (double), 1 cercle (simple)

cm ↑ cm

11398	50,0 x 40,0	65,0
-------	-------------	------



Buffetleiter Set

bowl stand set
set dispensador en escalera
set présentoir buffet en escalier



12-teilig: Buffetleiter für 7 Schalen (ø 23cm): 7 Melaminschalen (weiß), 3 Ringe (doppelt), 1 Ring (einzeln)

12 pcs.: bowl stand for 7 bowls (ø 23 cm): 7 melamine bowls (white), 3 rings (double), 1 ring (single)

set de 12 piezas: dispensador en escalera para 7 cuencos (ø 23 cm): 7 cuencos de melamina (en blanco), 3 aros (doble), 1 aro (sencillo)

set de 12 pièces: présentoir buffet en escalier pour 7 bols (ø 23 cm): 7 bols en melamine (en blanc), 3 cercles (double), 1 cercle (simple)

cm ↑ cm

11399	50,0 x 40,0	65,0
-------	-------------	------



Einzelteile / spare parts / piezas sueltas / pièces détachées

Buffetleiter / buffet ladder / dispensador en escalera / présentoir buffet en escalier

11395

Einzelring / single ring / aro sencillo / cercle simple

11396

Doppelring / double ring / aro sencillo / cercle double

11397



Bowl Box L



eckig, isolierendes Basiselement mit Melaminschüssel (weiß, Ø 23 cm)
 square, insulating base element with melamine bowl (white, Ø 23 cm)
 cuadrado, elemento básico aislante con cuencos de melamina (en blanco, ø 23 cm)
 carré, élément de base isolant avec bols en melamine (en blanc, ø 23 cm)

	cm	↑ cm	Farbe / Colour	
12925	26,5 x 26,5	8,5	stainless steel	
14925	26,5 x 26,5	8,5		wenge wood
13925	26,5 x 26,5	8,5		ahorn wood

	cm	↑ cm	Farbe / Colour	
12926	26,5 x 26,5	8,5	stainless steel	mit Deckel / with lid
14926	26,5 x 26,5	8,5		mit Deckel / with lid
13926	26,5 x 26,5	8,5		mit Deckel / with lid



Bowl Box S



eckig, isolierendes Basiselement mit Melaminschüssel (weiß, Ø 14 cm)
 square, insulating base element with melamine bowl (white, ø 14 cm)
 cuadrado, elemento básico aislante con cuencos de melamina (en blanco, ø 14 cm)
 carré, élément de base isolant avec bols en melamine (en blanc, ø 14 cm)

	cm	↑ cm	Farbe / Colour	
12920	17,4 x 17,4	6,0	stainless steel	
14920	17,4 x 17,4	6,0		wenge wood
13920	17,4 x 17,4	6,0		ahorn wood

	cm	↑ cm	Farbe / Colour	
12921	17,4 x 17,4	6,0	stainless steel	mit Deckel / with lid
14921	17,4 x 17,4	6,0		mit Deckel / with lid
13921	17,4 x 17,4	6,0		mit Deckel / with lid



Schale „CASUAL MAXI“



bowl
 cuenco
 bol

	Ø cm	↑ cm	litr.	Farbe / Colour
83700	14	6,5	0,50	
83702	23	10,5	2,50	
83701	14	6,5	0,50	
83703	23	10,5	2,50	



Edeltstahlschale, doppelwandig



stainless bowl, double wall
 bol inox doble pared
 bol inox double paroi



	Ø cm	↑ cm
30040	14	6,5
30042	23	10





Bowl Box S



rund, isolierendes Basiselement mit Melaminschüssel (weiß, Ø 14 cm)
 round, insulating base element with melamine bowl (white, Ø 14 cm)
 redondo, elemento básico aislante con cuencos de melamina (en blanco, ø 14)
 rond, élément de base isolant avec bols en melamine (en blanc, ø 14 cm)

	Ø cm	↑ cm	Farbe / Colour	
12910	17,4	6,0	stainless steel	
14910	17,4	6,0		wenge wood
13910	17,4	6,0		ahorn wood



	Ø cm	↑ cm	Farbe / Colour	
12911	17,4	6,0	stainless steel	mit Deckel / with lid
14911	17,4	6,0		mit Deckel / with lid
13911	17,4	6,0		mit Deckel / with lid





Bowl Box L



rund, isolierendes Basiselement mit Melaminschüssel (weiß, Ø 23 cm)
 round, insulating base element with melamine bowl (white, Ø 23 cm)
 redondo, elemento básico aislante con cuencos de melamina (en blanco, ø 23 cm)
 rond, élément de base isolant avec bols en melamine (en blanc, ø 23 cm)

	Ø cm	↑ cm	Farbe / Colour	
12915	26,5	8,5	stainless steel	
14915	26,5	8,5		wenge wood
13915	26,5	8,5		ahorn wood

	Ø cm	↑ cm	Farbe / Colour	
12916	26,5	8,5	stainless steel	mit Deckel / with lid
14916	26,5	8,5		mit Deckel / with lid
13916	26,5	8,5		mit Deckel / with lid



11875

Schale bowl cuenco bol



	Ø cm	↑ cm
11865	14	3,5
11875	23	10,5



10887

Frischhaltedeckel airtight cover tapa hermética couvercle hermétique



	Ø cm
10890	14
10887	23



Korb „GN LINE“

GN basket
GN cesta
GN corbeille



stabile Ausführung mit Edelstahldraht im Rand zur Stabilisierung
very solid with stainless steel wire frame to stabilize the basket
muy resistente con refuerzo de alambre inox
très résistante avec son fil de renfort inox

	cm	↑ cm	GN
40291	53,0 x 32,5	6,5	1/1
40290	32,5 x 26,5	6,5	1/2
40293	53,0 x 32,5	10,0	1/1
40292	32,5 x 26,5	10,0	1/2



Buffetkorb

buffet basket
cesta de buffet
corbeille de buffet



Polyrattan, mit Haubenschiene (ohne Haube)
polyrattan, with frame to fix the (without cover)
polyrattan, con fijación para campana (sin campana)
polyrattan, avec fixation pour la cloche (sans cloche)

	Ø cm	↑ cm
40295	40	12,5



GN Basket L

GN basket L
cesta GN L
corbeille GN L



Polyrattan, mit Haubenschiene (ohne Haube)
polyrattan, with frame to fix the cover (without cover)
polyrattan, con fijación para campana (sin campana)
polyrattan, con fijación para campana (sin campana)

	cm	↑ cm
40294	56,5 x 36,0	10,0



Rolltop-Haube

rolltop cover
campana abatible
cloche basculante



	Ø cm	↑ cm
18389	38	20



Eisbox „FRAMES“

ice box
bandeja hielo para el bufé
caisse à glaçons pour le buffet



3-teilig: 1 Basiselement Wenge + 1 Polystyrolwanne + 1 Tropfgitter
3 pcs. set: 1 box wenge + 1 plastic deep tray + 1 drainer plate
set 3 piezas : 1 cajón color wengué, 1 cubeta plástico, 1 rejilla
set 3 éléments: caisson couleur wengué, 1 bac plastique, 1 plaque perforée

	cm	↑ cm	GN	Farbe / Colour
14970	53 x 32,5	12,5	1/1	



GN Tablett „FRAMES“

GN tray
GN bandeja
GN plateau



	cm	↑ cm	GN
82355	53,0 x 32,5	2	1/1
82356	32,5 x 26,5	2	1/2
82357	32,5 x 17,6	2	1/3



Besteck- / Universal-Box, 2-teilig „FRAMES“

cutlery tray, 2 pcs.
cubertero o cajón multi-usos, 2pz.
caisson à couverts ou multi-usages



Buche massiv, Wenge, 4 Fächer, inklusive herausnehmbaren Einsatz
wood wenge, 4 compartments
madera de haya maciza, color wengué, 4 compartimentos, separadores removibles
hêtre massif, couleur wengé, 4 compartiments, séparateurs amovibles

	cm	↑ cm	Farbe / Colour
14956	53 x 32,5	11	■

Einsatz für GN 1/1 „FRAMES“ / insert for GN1/1 „FRAMES“ / interior para GN1/1 „FRAMES“ / insert pour GN1/1 „FRAMES“

	cm	↑ cm	Farbe / Colour
14954	48,5 x 28	8	■



Gestell für GN 1/1 „FRAMES“

serving stand
cubertero o cajón multi-usos
caisson à couverts ou multi-usages



Buche massiv, Wenge
wood, wenge
madera de haya maciza, wengué
hêtre massif, wengé

	cm	↑ cm	Farbe / Colour
14953	57,5 x 27,5	22	■

vielseitig einsetzbar für
alle GN 1/1 Artikel



14942
passendes GN 1/1
Basiselement



14956
Besteck / Universal-Box
GN 1/1

SUPERBOX

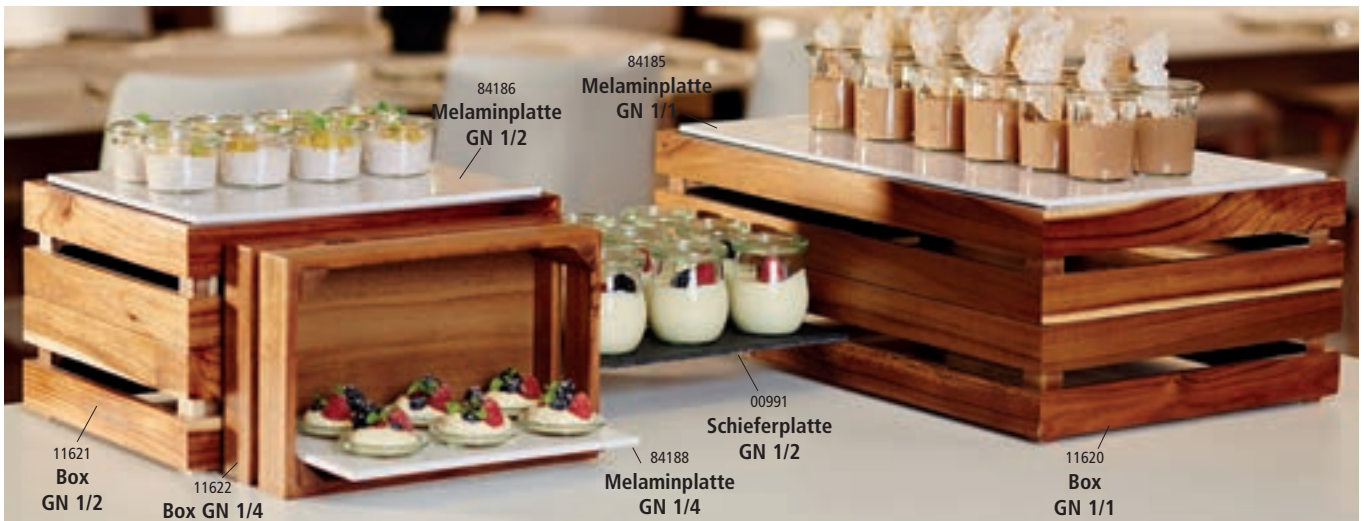

Buffetsystem „Superbox“ ist ein multifunktionales Buffetsystem, das sich in Höhe und Breite allen Platzanforderungen anpasst. Die stapelbaren Wendeboxen lassen sich rutschfest stapeln und mit flachen GN Platten verbinden und einzeln nutzen. Individuell können Buffetlandschaften gebaut werden.

„Superbox“ is a multifunctional buffet system that adapts in height and width to all space requirements. The stackable and non-slip reversible boxes can be connected to flat GN trays and can also be used individually. Different and individual buffet sceneries can be built up.

„Superbox“ es un sistema de bufé multifuncional que se adapta en altura y anchura a todos los requisitos de espacio. Las cajas girables y apilables son antideslizantes y se pueden conectar con bandejas planas GN o utilizar individualmente. Se pueden construir diferentes paisajes de bufé muy individuales.

„Superbox“ est un système de buffet multifonctionnel qui s'adapte en hauteur et en largeur à toutes les exigences de l'espace. Les boîtes de tournage empilables sont antiglissantes et peuvent être connectées avec des plateaux plats GN ou utilisées individuellement. Des paysages de buffet très personnalisés peuvent être construits.



GN Einsatz „SUPERBOX“

GN insert
GN bandeja
GN bac supérieur



	cm	↑ cm	GN	fits to
11616	53,0 x 32,5	8,5	GN 1/1	11620, 11626
11617	32,5 x 26,5	8,5	GN 1/2	11621, 11627





11626

GN 1/1 „SUPERBOX“



Akazienholz / acacia wood / madera de acacia / bois d'acacia

	cm	↑ cm	Farbe / Colour
11620	55,5 x 35,0	10,5	
11626	55,5 x 35,0	10,5	



11623

GN 2/4 „SUPERBOX“



Akazienholz / acacia wood / madera de acacia / bois d'acacia

	cm	↑ cm	Farbe / Colour
11623	55,5 x 18,5	10,5	
11629	55,5 x 18,5	10,5	



11627

GN 1/2 „SUPERBOX“



Akazienholz / acacia wood / madera de acacia / bois d'acacia

	cm	↑ cm	Farbe / Colour
11621	35 x 29	10,5	
11627	35 x 29	10,5	



11622

GN 1/4 „SUPERBOX“



Akazienholz / acacia wood / madera de acacia / bois d'acacia

	cm	↑ cm	Farbe / Colour
11622	29,0 x 18,5	10,5	
11628	29,0 x 18,5	10,5	



84185
Tablett GN 1/1

11620
Superbox GN 1/1

GN Tablett „ZERO“

GN tray
GN bandeja
GN plateau

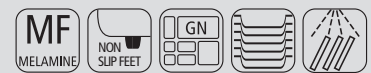

	cm	↑ cm	GN	Farbe / Colour
84185	53,0 x 32,5	1,5	1/1	
84195	53,0 x 32,5	1,5	1/1	
84186	32,5 x 26,5	1,5	1/2	
84196	32,5 x 26,5	1,5	1/2	
84188	26,5 x 16,2	1,5	1/4	
84198	26,5 x 16,2	1,5	1/4	
84189	53,0 x 16,2	1,5	2/4	
84199	53,0 x 16,2	1,5	2/4	



00991
Schieferplatte GN 1/2

11627
Superbox GN 1/2

GN Naturschieferplatten

GN natural slate tray
GN bandeja de pizarra natural
GN plat ardoise naturelle



	cm	GN
00990	53,0 x 32,5	1/1
00991	32,5 x 26,5	1/2
00993	26,5 x 16,2	1/4
00973	53,0 x 16,2	2/4

BRIDGE



Der „Alleskönner“ für Ihr Buffet! Mit hohem Anspruch an Design und Funktionalität haben wir das Buffet-System „Bridge“ für Sie entwickelt. Die perfekt aufeinander abgestimmten Komponenten unterstützen die Präsentation Ihrer Speisen und ermöglichen Ihnen den unkomplizierten Aufbau Ihrer einzigartigen Buffet-Landschaften. Die in den Holzoberflächen Ahorn und Wenge erhältlichen Artikel sind in ihren Höhen und ihren Volumina optimal aufeinander abgestimmt und gewährleisten einen einfachen und sicheren Umgang in Ihrem Gastronomiealltag.

The collection “Bridge” is bringing perfectly coordinated components for an uncomplicated and organized buffet system, finalizing in an unique buffet scenery. All pieces combine perfectly with one another in their variations of sizes and volumes. The wooden items are available in 2 colors, maple or wenge. A simple and safe handling is guaranteed.

Una colección universal para un buffé único: un sistema funcional y fácil de componer, asociado a la elegancia de su exclusivo diseño. Los elementos se combinan a la perfección entre variaciones de alturas y volúmenes, realizando sus propuestas y composiciones culinarias y modelando el paisaje del buffé. Las piezas están disponibles en 2 colores, wengué o arce. Manejo sencillo y seguro.

Une collection universelle pour une présentation unique de votre buffet: fonctionnel et facile à composer, ce système est à la fois pratique, simple et spectaculaire par son élégant design. Les différents éléments se marient à la perfection pour construire sans difficulté différentes compositions, variant les hauteurs et les volumes et mettant en valeur vos créations culinaires. Vous pouvez modeler vous-même votre buffet comme un paysage. Les pièces sont disponibles en deux couleurs, bois wengué ou érable. Manipulation aisée et sûre.



Kühlbox „BRIDGE“ refrigerated buffet display set de bufé refrigerado présentoir buffet froid



Set bestehend aus: 1 Gestell aus Ahorn oder Wenge, 1 Behälter aus Kunststoff, 1 GN1/1 Tablett aus Melamin, 1 Kühlakku, 1 Rolltophaube (fix montiert)
set consists of: 1 base element maple or wenge, 1 plastic insert black, 1 GN1/1 tray melamine, 1 cooler, 1 cover (fixed)

incluye: soporte de madera en arce o wengué, 1 cubeta de plástico, 1 bandeja de melamina GN1/1, 1 placa de frío GN 1/1, 1 campana rolltop (fija)
support bois en érable ou wengué, 1 bac plastique, 1 plat mélamine GN 1/1, 1 plaque de froid GN 1/1, 1 cloche rolltop (fixe)

	cm	↑ cm	Farbe / Colour	
13990	63,5 x 42,5	31		ahorn wood
14990	63,5 x 42,5	31		wenge wood



Kühlschale „BRIDGE“

cooling bowl
bol refrigerado
bol réfrigéré



4-teilig: 1 Gestell aus Ahorn oder Buche/Wenge, 1 Behälter aus Edelstahl, 1 Schale aus Melamin (Ø 14 cm o. 23 cm), 1 Kühlakku

4 pcs.: 1 base element maple or wenge, 1 bowl stainless steel, 1 bowl melamine (Ø 14 o. 23 cm), 1 cooler

set de 4 piezas: soporte madera arce o wengue, champanera inox de doble pared. alzador interior, acumulador de frío

set de 4 pcs: support bois en érable ou wengue, seau inox double paroi, rehausseur intérieur, accumulateur de froid

	cm	↑ cm	ltr.	Farbe / Colour
13980	18,5 x 18,5	10	0,50	
13981	27,5 x 27,5	14	2,50	

	cm	↑ cm	ltr.	Farbe / Colour
14980	18,5 x 18,5	10	0,50	
14981	27,5 x 27,5	14	2,50	



Edelstahlschale

stainless steel bowl
cuenco acero inoxidable
bol acier inoxydable



	Ø cm	↑ cm
30050	14	8,5
30052	23	13,5



Schale „CASUAL MAXI“

bowl
cuenco
bol



	Ø cm	↑ cm	ltr.	Farbe / Colour
83700	14	6,5	0,50	
83702	23	10,5	2,50	

	Ø cm	↑ cm	ltr.	Farbe / Colour
83701	14	6,5	0,50	
83703	23	10,5	2,50	



Frischhaltedeckel

airtight cover
tapa hermética
couvre-cle hermétique



	Ø cm
10890	14
10887	23

Kühlakku / cooler / acumulador de frío / accumulateur de froid

	Ø cm	↑ cm
10661	10,5	2,5
10777	15	2,5



Cerealienspender „BRIDGE“

cereal dispenser
dispensador de cereales
distributeur de céréales



Behälter herausnehmbar, „Feierabend-Deckel“ für das aromadichte Lagern, portionieren durch einfaches Drehen

removable canister, special lid to keep the cereals fresh, easy to use, rotate the button to get the muesli

contenedor movable, tapa especial para mantener los cereales

frescos, fácil de usar, se gira el pomo para servir los cereales

réceptient amovible, couvercle spécial pour conserver les céréales, usage facile en tournant le bouton

	cm	↑ cm	ltr.	Farbe / Colour	
13987	21 x 20	55,5	4,5		Ahorn / maple



inkl. 3 Magnetschilder:
ORANGE, APPLE, GRAPEFRUIT

4 ltr.

10870

Saftdispenser „BRIDGE“

juice dispenser
dispensador de zumo
distributeur à jus



Kühlung durch 2 Kühlakkus von oben und unten

cooling with 2 cooling elements from the top and base

2 acum. de frío 1 en la base y 1 en la tapa

2 plaques de froid 1 dans le couvercle, 1 dans le socle

	cm	↑ cm	ltr.	Farbe / Colour	
10870	31,0 x 20,0	42	4		Ahorn / maple
10871	35,5 x 22,0	50	6		Ahorn / maple

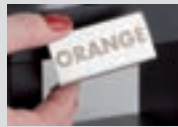

Besteckbehälter „BRIDGE“

cutlery organizer
cajón para cubiertos
bac à couverts



2 teiliges Set: 1 Gestell, 1 Besteckbehälter (Nr. 11955), herausnehmbar

2 pcs set: 1 base element, 1 removable plastic container (item 11955)

set de 2 piezas: 1 soporte + 1 cubeta extraíble

4 compartimentos de plástico (ref. 11955)

set de 2 pcs: 1 support + 1 bac plastique amovible à 4 compartiments (réf. 11955)

	cm	↑ cm	Farbe / Colour	
13995	57,5 x 37,0	12		Ahorn / maple



Konferenzkühler „BRIDGE“

bottle cooler
enfriador
refraîchisseur



2-teiliges Set, bestehend aus: 1 Gestell, 1 Behälter aus Edelstahl (doppelwandig)

2 pcs set: 1 base element, 1 bowl stainless steel (double-wall)

set de 2 piezas: 1 soporte, champanera inox de doble pared

set de 2 pcs: 1 support, seau inox double paroi

	cm	↑ cm	Farbe / Colour	
13985	35 x 35	19		Ahorn / maple



Cerealispender „BRIDGE“

cereal dispenser
dispensador de cereales
distributeur de céréales



Behälter herausnehmbar, „Feierabend-Deckel“ für das aromadichte Lagern, portionieren durch einfaches Drehen

removable canister, special lid to keep the cereals fresh, easy to use, rotate the button to get the muesli

contenedor movable, tapa especial para mantener los cereales

frescos, fácil de usar, se gira el pomo para servir los cereales

réceptif amovible, couvercle spécial pour conserver les céréales, usage facile en tournant le bouton

	cm	↑ cm	ltr.	Farbe / Colour	
14987	21 x 20	55,5	4,5		Wenge / wenge



Saftdispenser „BRIDGE“

juice dispenser
dispensador de zumo
distributeur à jus



Kühlung durch 2 Kühlakkus von oben und unten

cooling with 2 cooling elements from the top and base

2 acum. de frío 1 en la base y 1 en la tapa

2 plaques de froid 1 dans le couvercle, 1 dans le socle

	cm	↑ cm	ltr.	Farbe / Colour	
10872	31,0 x 20,0	42	4		Wenge / wenge
10873	35,5 x 22,0	50	6		Wenge / wenge

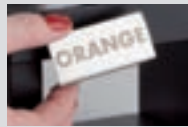

Besteckbehälter „BRIDGE“

cutlery organizer
cajón para cubiertos
bac à couverts



2 teiliges Set: 1 Gestell, 1 Besteckbehälter (Nr. 11955), herausnehmbar

2 pcs set: 1 base element, 1 removable plastic container (item 11955)

set de 2 piezas: 1 soporte + 1 cubeta extraíble

4 compartimentos de plástico (ref. 11955)

set de 2 pcs: 1 support + 1 bac plastique amovible à 4 compartiments (réf. 11955)

	cm	↑ cm	Farbe / Colour	
14995	57,5 x 37,0	12		Wenge / wenge



Konferenzkühler „BRIDGE“

bottle cooler
enfriador
refraîchisseur



2-teiliges Set, bestehend aus: 1 Gestell, 1 Behälter aus Edelstahl (doppelwandig)

2 pcs set: 1 base element, 1 bowl stainless steel (double-wall)

set de 2 piezas: 1 soporte, champanera inox de doble pared

set de 2 pcs: 1 support, seau inox double paroi

	cm	↑ cm	Farbe / Colour	
14985	35 x 35	19		Wenge / wenge

SUNDAY

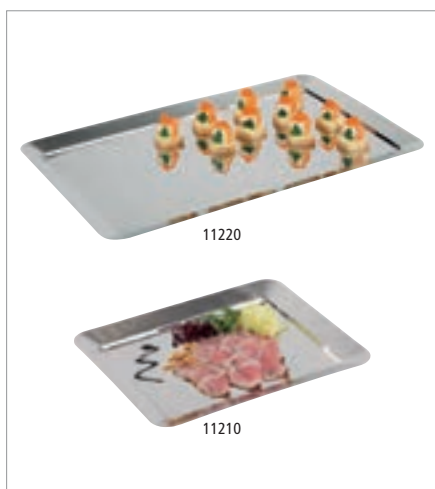

GN Tablett „SUNDAY“

GN tray
GN bandeja
GN plateau



hochglanzpoliert
mirror polished finish
acabado espejo pulido
effet brillant

	cm	↑ cm	GN
11220	53,0 x 32,5	2	1/1
11210	32,5 x 26,5	2	1/2



Tablett „SUNDAY“

tray
bandeja
plateau



hochglanzpoliert
mirror polished finish
acabado espejo pulido
effet brillant

	Ø cm	↑ cm
11211	46	2



GN Tablett „SUNDAY“

GN tray
GN bandeja
GN plateau



hochglanzpoliert, Griffe inkl. Fixierung, kein Verrutschen möglich, Nutzhöhe 4 cm
mirror polished finish, with handles for extra secure stacking, distance 4 cm
pulido espejo, con 2 asas para apilado muy estable, distancia 4 cm entre bandejas
effet brillant, 2 anses pour empilement très stable, distance 4 cm entre plateaux

	cm	↑ cm	GN
11222	53,0 x 32,5	6	1/1
11212	32,5 x 26,5	6	1/2



11230

mit Haubenfixierung

Kühlbox „SUNDAY“

cooling plate
bandeja refrigerada
présentoir buffet réfrigéré



3-teilig: 1 Schale inkl. Haubenfixierung + 1 Tablett + 1 Kühlakku, hochglanzpoliert, ohne Haube

3 pcs. set: 1 tray with cover holder + 1 tray + 1 cooler, mirror polished finish, without rolltop cover

3 piezas: 1 bandeja inox con fijaciones para campana + 1 bandeja inox + 1 acumulador de frío, campana no incluida

3 éléments: 1 plateau inox avec fixations pour la cloche + 1 plateau inox + 1 accum. de froid, cloche non incluse

	cm	↑ cm	GN
11230	53,0 x 32,5	5	1/1

GN 1/1 Rolltophaube „SUNDAY“ / GN 1/1 rolltop cover / GN 1/1 campana rolltop / GN 1/1 cloche rolltop

	cm	↑ cm	GN
11016	53,0 x 32,5	19	1/1

Kühlakku / cooler / acumulador de frío / accumulateur de froid

	cm	↑ cm
10782	41 x 21	2,5



Buffetgestell „SUNDAY“

buffet stand
expositor bufé
présentoir buffet



3-teiliges Set: 1 Glasschale Ø 23 cm (2,5 Liter), 1 klappbarer Schutzdeckel, 1 Gestell

3 pcs. set: 1 glass bowl Ø 23 cm (2,5 litres), 1 hinged covers, 1 stand

3 piezas: 1 bol vidrio Ø 23 cm (2,5 l), 1 tapa con bisagra, 1 soporte

3 éléments: 1 bol verre Ø 23 cm (2,5 l), 1 couvercle à charnière, 1 support

	Ø cm	↑ cm
11794	24	17



Buffetgestell „SUNDAY“

buffet stand
expositor bufé
présentoir buffet



7-teiliges Set: 3 Glasschalen Ø 23 cm (2,5 Liter), 3 klappbare Schutzdeckel, 1 Gestell

7 pcs. set: 3 glass bowls Ø 23 cm (2,5 litres), 3 hinged covers, 1 stand

7 piezas: 3 boles vidrio Ø 23 cm (2,5 l), 3 tapas con bisagra, 1 soporte

7 éléments: 3 bols verre Ø 23 cm (2,5 l), 3 couvercles à charnière, 1 support

	cm	↑ cm
11795	61 x 24	35



Saftdispenser „SUNDAY“

juice dispenser
dispensador de zumo
distributeur à jus de fruit



matt poliert, Kühlung durch 2 Kühlakkus von oben und unten
satin polished finish, cooling with 2 cooling elements from the top and base
acabado pulido brillante, 2 acum. de frío (1 en la base y 1 en la tapa)
inox mat, 2 accus. de froid (1 socle et 1 couvercle)

	cm	↑ cm	ltr.
10860	21 x 35	48	6

Saftbehälter transparent, ohne Zapfhahn / juice canister transparent, without tap / contenedor transparente sin grifo / récipient cylindrique sans le robinet

	Ø cm	↑ cm	ltr.
10806	22	26	6

Hahn / tap / grifo / robinet

10867



Saft- / Milchdispenser „SUNDAY“

juice and milk dispenser
dispensador mixto zumo y leche
distributeur mixte à lait et à jus de fruit



matt poliert, Behälter gefrostet, Kühlung durch 2 Kühlakkus von oben und unten
satin polished finish, canister frosted look, cooling with 2 cooling elements from the top and base
inox acabado pulido mate, 1 recipiente polycarbonato aspecto glaseado, 2 enfriadores en la base y en la tapa
inox mat, récipient polycarbonate opaque, 2 accus. de froid dans le socle et dans le couvercle

	cm	↑ cm	ltr.
10865	21 x 35	48	6

Milchbehälter, gefrostet, ohne Zapfhahn / milk canister, frosted look, without tap / contenedor de leche, efecto glaseado, sin grifo / récipient cylindrique mat (idéal pour le lait) sans le robinet

	Ø cm	↑ cm	ltr.
10805	22	26	6

Hahn / tap / grifo / robinet

10867



Saftdispenser DUO „SUNDAY“

juice dispenser
dispensador de zumo doble
distributeur à jus de fruit double



matt poliert, Kühlung durch 4 Kühllakkus von oben und unten

satin polished finish, cooling with 4 cooling elements from the top and base

inox acabado pulido mate, 4 enfriadores en la base y en la tapa
inox mat, 4 accus. de froid (socle et couvercle)

	cm	↑ cm	ltr.
10862	35 x 45	48	2 x 6

Saftbehälter transparent, ohne Zapfhahn / juice canister transparent, without tap / contenedor transparente sin grifo / récipient cylindrique sans le robinet

	Ø cm	↑ cm	ltr.
10806	22	26	6

Hahn / tap / grifo / robinet

10867



Saft- / Milchdispenser DUO „SUNDAY“

juice and milk dispenser
dispensador mixto zumo y leche
distributeur mixte à lait et à jus de fruit



matt poliert, 1 Behälter gefrostet, 1 Behälter transparent, 4 Kühllakkus von oben und unten

satin polished finish, 1 canister frosted look, 1 canister transparent, cooling with 4 cooling elements from the top and base

inox mate, 1 recipiente opaco, 1 recipiente transparente, 4 enfriadores (base y tapa)
inox mat, 1 récipient opaque, 1 récipient transparent, 4 accus. de froid (socle et couvercle)

	cm	↑ cm	ltr.
10864	35 x 45	48	2 x 6

Milchbehälter, gefrostet, ohne Zapfhahn / milk canister, frosted look, without tap / contenedor de leche, efecto glaseado, sin grifo / récipient cylindrique mat (idéal pour le lait) sans le robinet

	Ø cm	↑ cm	ltr.
10805	22	26	6

Saftbehälter transparent, ohne Zapfhahn / juice canister transparent, without tap / contenedor transparente sin grifo / récipient cylindrique sans le robinet

	Ø cm	↑ cm	ltr.
10806	22	26	6

Hahn / tap / grifo / robinet

10867

FOCUS



Bei der Serie FOCUS liegt der Fokus nicht auf dem Artikel selbst, sondern auf dem Food, welches auf Focus präsentiert wird. Die puristische Anmutung der Artikel wirkt zurückhaltend und unaufdringlich. Die Farben weiß und schwarz, sowie die Formen rund und eckig verhalten sich so neutral, dass eine Kombination mit anderen Buffetartikeln jederzeit möglich ist.

In the FOCUS series, the focus is not on the article itself, but on the food, which is presented on FOCUS. The puristic appearance of the articles has a discreet and unobtrusive look. The colors white and black, as well as the shapes round and square behave so neutrally that a combination with other buffet items is possible at any time.

En la serie FOCUS, el enfoque no está en el artículo en sí, sino en la comida presentada en esta serie. La apariencia purista de los artículos tiene un aspecto discreto. Los colores blanco y negro, así como las formas redondas y cuadradas son tan neutrales que una combinación con otros artículos del buffet es posible en cualquier momento.

Dans la série FOCUS, l'accent n'est pas sur l'article lui-même, mais sur la nourriture, qui est présenté sur cette série. L'aspect puriste des articles a un regard discret. Les couleurs blanches et noires, ainsi que les formes rondes et angulaires sont neutre qu'une combinaison avec d'autres articles de buffet est possible à tout moment.



stapelbar
stackable
apilables
empilable



mit Antirutsch-Füßchen
non-slip feet
con pies antideslizantes
avec pieds antidérapants



Buffet-Set „FOCUS“

buffet set
set de bufé
présentoir pour le buffet



4-teilig: Box, Tablett, 2 Kühlakku
4 pcs.: box, tray, 2 cooler
4 piez.: box, bandeja, 2 enfriadores
4 éléments: caisson, 2 plateau, bac

	cm	↑ cm	Farbe / Colour
09000	43,5 x 32,5	6	White
09001	43,5 x 32,5	6	Black

Edelstahltablett / tray / bandeja / plateau

	cm	↑ cm
09010	43,5 x 32,5	1,5

Holzschneidebrett / wooden board / tablero de madera / planche à découper

	cm	↑ cm
09016	43,5 x 32,5	2

Basisteil / base / base / base

	cm	↑ cm	Farbe / Colour
09011	42,5 x 31,5	6	White
09012	42,5 x 31,5	6	Black

Rolltopphaube „PURE“ / rolltop cover / campana abatible / cloche basculante

	cm	↑ cm
09013	44 x 33,5	17

Kühlakku / cooler / acumulador de frío / accumulateur de froid

	cm	↑ cm
10791	25 x 19	2,5

halten bis zu 6 Stunden kühl



Buffet-Set „FOCUS“

buffet set
set de bufé
présentoir pour le buffet



3-teilig: Box, Tablett, 1 Kühlakku
3 pcs.: box, tray, 1 cooler
3 piez.: box, bandeja, 1 enfriador
3 éléments: caisson, 1 plateau, bac

	Ø cm	↑ cm	Farbe / Colour
09002	38	6	White
09003	38	6	Black

Edelstahltablett / tray / bandeja / plateau

	Ø cm	↑ cm
09020	38	1,5

Basisteil / base / base / base

	Ø cm	↑ cm	Farbe / Colour
09021	37	6	White
09022	37	6	Black

Rolltopphaube / rolltop cover / campana abatible / cloche basculante

	Ø cm	↑ cm
09023	38	20

halten bis zu 6 Stunden kühl

PROFI LINE



GN Edelstahl-Tablett „PROFI LINE“

GN tray
GN bandeja
GN plat empilable système catering



	cm	↑ cm	GN	
11100	53,0 x 32,5	1,5	1/1	mit glattem Rand / without decor-edge sin borde decorado / bords lisses
12100	32,5 x 26,5	1,5	1/2	mit glattem Rand / without decor-edge sin borde decorado / bords lisses
11000	53,0 x 32,5	1,5	1/1	mit Dekor-Rand / with decor-edge con borde decorado / bords avec relief
12000	32,5 x 26,5	1,5	1/2	mit Dekor-Rand / with decor-edge con borde decorado / bords avec relief
11110	53,0 x 32,5	1,0	1/1	glatter schmaler Rand / smooth narrow edge borde estrecho liso / bord étroit lisse



GN Edelstahl-Behälter „PROFI LINE“

GN pan
GN cubeta
GN bac



	cm	↑ cm	GN	ltr.
11020	53,0 x 32,5	2,0	1/1	1,7
11040	53,0 x 32,5	4,0	1/1	3,4
11065	53,0 x 32,5	6,5	1/1	7,0
12040	32,5 x 26,5	4,0	1/2	2,0
12065	32,5 x 26,5	6,5	1/2	3,3



Fleisch- und Gemüseplatte „PROFI LINE“

tray
fuente de servicio
plat de service



Dekorrand hochglanzpoliert
decor edge mirror polished finish
borde decorado pulido efecto espejo
contour relief avec effet miroir

	Ø cm	↑ cm
11032	32	2,6
11038	38	2,6
11048	48	2,6



Fleisch- und Gemüseplatte „PROFI LINE“

tray
fuente de servicio
plat de service



Dekorrand hochglanzpoliert
decor edge mirror polished finish
borde decorado pulido efecto espejo
contour relief avec effet miroir

	cm	↑ cm
11023	50 x 36	2,6
11024	60 x 41	2,6
11025	70 x 46	2,6



GN 1/1 System-Tablett „PROFI LINE“

GN 1/1 tray
GN 1/1 bandeja
GN 1/1 plateau empilable système catering



Dekorrand hochglanzpoliert, massive Griffe verchromt, inkl. fest verschraubten Distanzstücken, Nutzhöhe 4 cm
decor edge mirror polished finish, chrome plated handles, incl. mounted 4 cm distance pillars
borde pulido decorado, asas cromadas, incluye distanciadores a 4 cm
bords polis avec reliefs, poignées chromées, distance approx. 4 cm

	cm	GN
11300	53 x 32,5	1/1

8 cm Distanzstück 4 Stück, verchromt / 8 cm distance pillars 4 pcs., chrome plated / distanciadores a 8 cm, 4 piezas, plateado / 8 cm Kit réhausseur 4 pièce, chromée

11310 8 cm Distanzstücke können per Hand aufgeschraubt werden
8 cm distance pieces can be bolted by hand

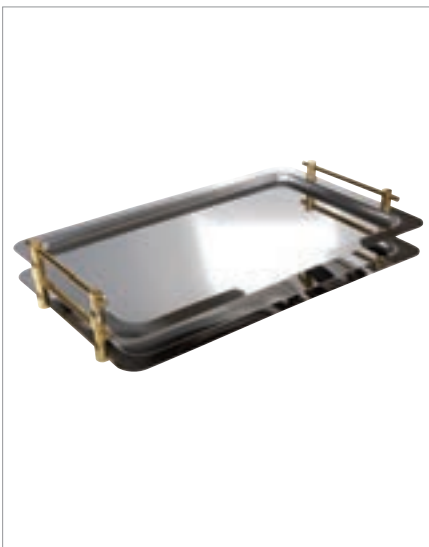

GN 1/1 System-Tablett „PROFI LINE“

GN 1/1 tray
GN 1/1 bandeja
GN 1/1 plat empilable système catering



Rand hochglanzpoliert, massive Bügelgriffe vergoldet, inkl. fest verschraubten Distanzstücken, Nutzhöhe 4 cm
mirror polished finish edge, gold plated handles, stackable approx. 4 cm
borde con acabado pulido, asas doradas, apilables aproximadamente 4 cm
contour effet miroir, poignées dorées, empilables distance 4 cm environ

	cm	GN
11290	53 x 32,5	1/1

8 cm Distanzstück-Set, 4 Stück, vergoldet / 8 cm distance pillars, 4 pcs., gold plated / distanciadores a 8 cm, 4 piezas, dorado / 8 cm kit réhausseur, 4 pièces, dorée

11252 8 cm Distanzstücke können per Hand aufgeschraubt werden
8 cm distance pieces can be bolted by hand



GN 1/1 Haube „HOCHSTAPLER“

GN 1/1 cover
GN 1/1 campana
GN 1/1 cloche



glasklarer Kunststoff, Tablett fixiert sich auf der Haube - kein Rutschen möglich, nahezu bruchfest
clear plastic, tray fixes itself on the cover and can not slip off, nearly unbreakable
plástico transparente, la bandeja se fija a la tapa para que no se deslice, muy resistente a la rotura
en plastique transparent, le plat se fixe sur le dessous de la cloche pour ne pas glisser, très résistant à la casse

	cm	↑ cm	GN	fits to
11305	53 x 32,5	9	1/1	11300, 11290, 11295



GN Abdeckhaube

GN cover
GN cubierta
GN cloche



	cm	↑ cm	✂ mm	GN
11041	32,5 x 26,5	9,5	3	1/2
11042	53,0 x 32,5	9,5	3	1/1





Buffet & Service

Tablets
Karaffen
Dispenser
Buffetständer
Isolierkannen

bandejas
jarra
dispensadores
soportes para bufé
jarras termo

trays
carafe
dispenser
buffet stands
vacuum jugs

plateaus
pichet
distributeurs
présentoires buffet
bouteilles isotherme

Naturschiefer



GN Naturschieferplatten

GN natural slate tray
GN bandeja de pizarra natural
GN plat ardoise naturelle



hervorragende Kältespeicherung durch Naturschiefer, die Kanten der Platten sind gebrochen und nicht gesägt
excellent coldness store, food safe, waterproof
excelente conservador del frío, para reforzar la estética natural, los bordes ofrecen un canto irregular
excellent maintien du froid, les bords sont volontairement cassés pour renforcer l'esthétique naturelle

	cm	* mm	GN
00990	53,0 x 32,5	6 - 9	1/1
00991	32,5 x 26,5	6 - 9	1/2
00992	32,5 x 17,6	6 - 9	1/3
00993	26,5 x 16,2	6 - 9	1/4
00973	53,0 x 16,2	6 - 9	2/4



Naturschieferplatte

natural slate tray
bandeja de pizarra natural
plat ardoise naturelle



	cm	* mm
00996	45 x 30	6 - 9

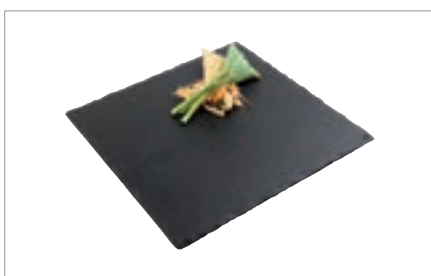

Naturschieferplatte

natural slate tray
bandeja de pizarra natural
plat ardoise naturelle



	cm	* mm
00994	25 x 25	6 - 9
00995	30 x 30	6 - 9

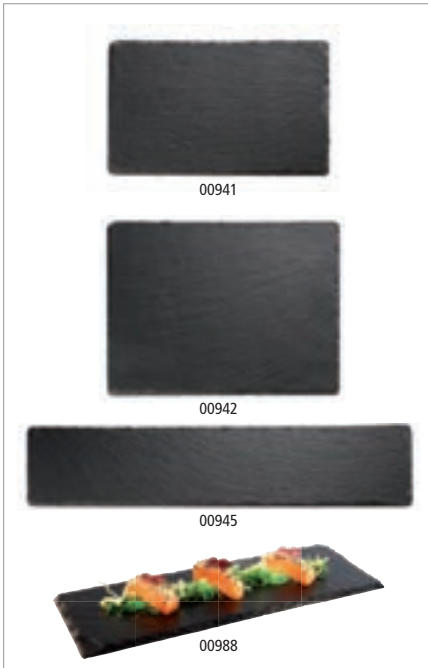

Naturschieferplatte
 natural slate
 bandeja de pizarra natural
 plateau ardoise naturelle



	cm	✦ mm
00941	24,0 x 15,0	6 - 9
00942	26,5 x 20,5	6 - 9
00945	47,0 x 10,0	6 - 9
00988	30,0 x 12,0	6 - 9

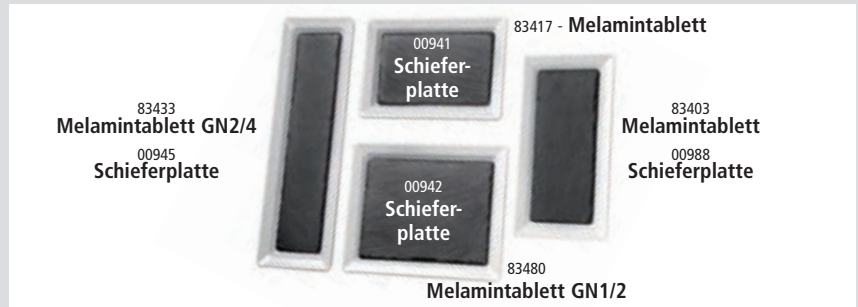

GN 1/1 Naturschieferplatte „HOCHSTAPLER“
 GN 1/1 natural slate tray
 GN 1/1 bandeja de pizarra natural
 GN 1/1 plat ardoise naturelle



	cm	↑ cm	✦ mm
00966	53,0 x 32,5	6	6 - 9



Griffe verchromt, 4 cm Nutzhöhe
 chrome plate handles, 4 cm distance



Naturschieferplatte, 2er Set
 natural slate tray, 2 pcs.
 bandeja de pizarra natural, 2 pz.
 plat ardoise naturelle, 2 pc.



mit Safrinne
 with juice groove
 con canal de jugo
 avec canal de jus

	∅ cm	✦ mm	pcs.
00935	23	6 - 9	2



Naturschieferplatte, 2er Set
 natural slate tray, 2 pcs.
 bandeja de pizarra natural, 2 pz.
 plat ardoise naturelle, 2 pc.



mit Safrinne
 with juice groove
 con canal de jugo
 avec canal de jus

	cm	✦ mm	pcs.
00936	26 x 20	6 - 9	2



Naturschieferplatte „STARTER“

natural slate tray
bandeja de pizarra natural
plat ardoise naturelle carré



	cm	✱mm
00937	20 x 10	6 - 9
00938	30 x 10	6 - 9
00939	30 x 15	6 - 9



Weck-Glas 82316

Naturschieferplatte / Untersetzer

natural slate tray
bandeja de pizarra natural
plateau ardoise naturelle



mit 2 Absätzen Ø 6 cm
with 2 holes Ø 6 cm
con 2 agujeros Ø 6 cm
avec 2 trous Ø 6 cm

	cm	✱mm
00971	15 x 8	6 - 9



Naturschieferplatte

natural slate tray
bandeja de pizarra natural
plat ardoise naturelle



	Ø cm	✱mm
00968	22	6 - 9
00969	28	6 - 9
00998	33	6 - 9
00999	38	6 - 9



Tortenplatte / Servierplatte drehbar

cake stand
soporte para pastel
présentoir à gâteaux



	Ø cm	↑ cm	✱mm
00975	32	2,5	6 - 9



drehbar
rotating



Rolltop-Set, 3-teilig

rolltop set, 3 pcs.
set rolltop, 3 piezas
set rolltop, 3 pièces



1 Edelstahltablett Ø 38 cm + 1 Naturschieferplatte Ø 33 cm + 1 Rolltophaube Ø 38 cm
1 stainless tray Ø 38 cm + 1 natural slate tray Ø 33 cm + 1 rolltop cover Ø 38 cm
1 bandeja de acero inoxidable Ø 38 cm + 1 bandeja de pizarra natural Ø 33 cm + 1 tapa abatible Ø 38 cm
1 plat inox 38 cm + 1 plat ardoise naturelle 33 cm + 1 cloche 38 cm

	Ø cm	↑ cm
01000	38	24



3-stufige Etagère
3-tier tray
bandeja con tres alturas
étagère carré 3 hauteurs



Naturschiefer, Akazienholz
natural slate tray, wood akazie
bandeja de pizarra natural, madera
plateau ardoise naturelle, bois

	Ø cm	↑ cm	* mm
00960	30 / 25 / 20	34	6 - 9



2-stufige Etagère
2 tier tray
bandeja dos alturas
plat carré 2 hauteurs



Naturschiefer
natural slate tray
bandeja de pizarra natural
plateau ardoise naturelle

	Ø cm	↑ cm	* mm
00989	25 / 20	24	6 - 9



Naturschieferplatte, 2-teilig
natural slate tray, 2 pcs. set
bandeja de pizarra natural y campana
plateau ardoise naturelle et cloche en verre

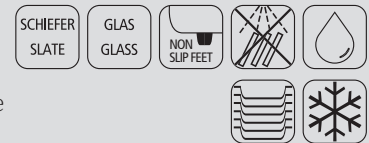

mit Glashaube
with glass cover
con tapa de cristal
avec cloche en verre

	Ø cm	↑ cm	* mm
00984	10,5	8	6 - 9



Naturschieferplatten, 4er Set
natural slate tray, 4 pcs. set
bandeja pizarra natural, set de 4 unidades
plat ardoise naturelles, pack de 4



	cm	* mm	pcs.
00997	10 x 10	6 - 9	4



GENUSSPALETTE

NEW



GN 1/1



40672

GN 1/1 Servierbrett „GENUSSPALETTE“

GN 1/1 serving board
GN 1/1 tabla de servir
GN 1/1 planche de service

HOLZ
WOOD



Genusspalette im Kleinformat, Birke
mini serving palett, birch
tabla de servir, formato pequeño, abedul
planche de service, petit format, bouleau

	cm	↑ cm	GN
00879	53,0 x 32,5	3	1/1

Wachspapier „SNACKHOLDER“ / greaseproof paper squares
papel alimenticio para cucurucho / papier alimentaire pour cornet

	cm	pcs.	
40670	42 x 25	500	Motiv: Zeitung
40671	42 x 25	500	blank
40672	42 x 25	500	Motiv: rote Karos / red
40673	42 x 25	500	Motiv: blaue Karos / blue



40670



40672



40673



00880



40672

00881



40670

00882

Servierbrett „GENUSSPALETTE“

serving board
tabla de servir
planche de service

HOLZ
WOOD



Genusspalette im Kleinformat, Birke
mini serving palett, birch
tabla de servir, formato pequeño, abedul
planche de service, petit format, bouleau

	cm	↑ cm	
00880	20 x 12	3	
00881	30 x 20	3	
00882	40 x 15	3	

Wachspapier „SNACKHOLDER“ / greaseproof paper squares
papel alimenticio para cucurucho / papier alimentaire pour cornet

	cm	pcs.	
40670	42 x 25	500	Motiv: Zeitung
40671	42 x 25	500	blank
40672	42 x 25	500	Motiv: rote Karos / red
40673	42 x 25	500	Motiv: blaue Karos / blue



40670



40672



40673



00867



00868



00869

Servierbrett „AKAZIE-SCHIEFER“

serving board
tabla de servir
planche de service

SCHIEFER
SLATE

HOLZ
WOOD



raffiniertes, rustikales Servierbrett
aus Akazienholz, ausgestattet mit einem Naturschieferstreifen
zur Kennzeichnung

wood with slate, markable
madera con pizarra, se puede marcar
bois avec ardoise, on peut mettre une inscription

	cm	↑ cm
00867	30,5 x 13,0	1,5
00868	36,5 x 15,0	1,5
00869	42,0 x 18,0	1,5



00870



00873



00875

Servierbrett „OLIVE“

serving board
tabla de servir en madera de olivo
planche de service en bois d'olivier

HOLZ
WOOD



Servierbrett im Naturschnitt, aus Olivenholz. Jedes Brett wird handgefertigt und lackiert mit 19 mm Aufhäng Bohrung. Alle Produkte unterscheiden sich naturbedingt in Form, Maserung und Größe!

Olive Wood is known for its versatility and striking appearance with each piece having its own unique features.

El olivo es conocido por su versatilidad y aspecto espectacular y único en cada pieza. Por su fabricación a mano de forma artesanal, todas las piezas varían en tamaño, forma y acabado, lo que hace de cada una un ejemplar único.

Le bois d'olivier est reconnu pour sa versatilité et son esthétique spectaculaire. De par leur fabrication artisanale à la main, toutes les pièces varient quant à leur taille, forme et finition, de telle sorte que chacune est un exemplaire unique.

	cm	↑ cm	Griff / handle cm
00870	25,0 x 17,0	1,5	
00871	30,0 x 20,5	2,0	
00872	35,0 x 24,0	2,0	
00873	40,0 x 15,0	1,5	11
00874	44,0 x 20,0	2,0	12
00875	19,0 x 12,5	1,5	6
00876	25,0 x 16,0	1,5	8
00877	31,0 x 20,0	1,5	9



Buffetbrett „XXL“

board
tabla para el bufé
planche à découper buffet



Buchenholz geölt, mit Antirutsch-Füßchen
beech wood oiled, with non-slip feet
madera de haya tratada con aceite, pies antideslizantes
bois hêtre huilé, pieds antiglisse

	Ø cm	↑ cm
00866	50	4,5



Buffetbrett

board
tabla para el bufé
planche à découper buffet



Buchenholz, mit Antirutsch-Füßchen, ohne Haube
beech wood, with non-slip feet, without cover
haya, pies antideslizantes, sin tapa
hêtre, pieds antidérapants, sans cloche

	cm	↑ cm
00865	58 x 38	2,5



Griffmulde
recessed grip



Brezel- oder Wurstständer

pretzel-/ sausage stand
soporte para embutidos
support à bretzel ou à saucissons



Verkaufsständer Buchen-Holz versiegelt, bestens geeignet für die Präsentation von Brezeln, Würstchen, etc., Fuß Ø 22 cm

beech wood, ideal to present pretzels, sausages, etc.
madera de haya, ideal para presentar fiambres, salchichones etc.
en hêtre, idéal pour bretzels ou saucissons, etc.

	Ø cm	↑ cm
79553	28	50

Hygieneschutz für Brezelständer / hygienic cover / cubierta higiénica antialiento / pare-haleine

	cm	↑ cm
11557	20 x 20 x 20	50



Hobel für Käse und Schokolade

cheese / choco curler
rizador para queso y chocolate
frisette pour fromage et chocolat



3-teilig: Platte Buchen-Holz versiegelt Ø 22 cm mit senkrechtem Stift + Hobel 7 cm + Haube Ø 15 x 10 cm, für Käse und Schokolade

3 pcs. set: wooden base Ø 22 cm with vertical bolt + plough 7 cm + cover Ø 15 x 10 cm, for cheese and choco

set de 3 piezas: base de madera Ø 22 cm, con eje vertical de 7 cm+ campana Ø 15 x 10 cm, para „rizar“ queso y chocolate

set 3 pièces pour „friser“ le fromage ou le chocolat: base bois Ø 22 cm, axe vertical ht. 7 cm, cloche Ø 15 x ht 10 cm

	Ø cm	↑ cm
50002	22	15

NEW



82357

GN Tablett „FRAMES“

GN tray
GN bandeja
GN plateau



	cm	↑ cm	GN
82355	53,0 x 32,5	2	1/1
82356	32,5 x 26,5	2	1/2
82357	32,5 x 17,6	2	1/3



82355
GN 1/1

82356
GN 1/2

82357
GN 1/3

NEW



82202

GN Tablett

GN tray
GN bandeja
GN plateau



	cm	↑ cm	GN
82201	53,0 x 32,5	2,5	1/1
82202	32,5 x 26,5	2,5	1/2
82203	32,5 x 17,6	2,5	1/3
82204	53,0 x 16,2	2,5	2/4
82205	35,4 x 32,5	2,5	2/3



„extra strong“



83305

GN Servier- / Buffetplatte

GN dish
GN bandeja bufé
GN plat buffet



	cm	↑ cm	GN
83301	53,0 x 32,5	2	1/1
83305	32,5 x 26,5	2	1/2
83304	32,5 x 17,5	2	1/3
83303	53,0 x 16,2	2	2/4



GRANITE



Die neue Serie „GRANITE“ besteht durch ihre aus Naturstein gefertigten Tablett, die eine hervorragende Kältespeicherung aufweisen.

The new collection „GRANITE“ impresses with its natural stone-made trays, which have an excellent cold storage.

La nueva serie „GRANITE“ impresiona con sus bandejas de piedra natural y conservan el frío excelentemente.

La nouvelle série „GRANITE“ impressionne par ses plateaux en pierre naturelle, qui ont un excellent maintien du froid.



GN Tablett „GRANITE“

GN tray
GN bandeja
GN plateau



	cm	mm	GN
00920	53,0 x 32,5	16	1/1
00921	32,5 x 26,5	16	1/2



GN Tablett „GRANITE“

GN tray
GN bandeja
GN plateau



	cm	mm	GN
00922	32,5 x 17,6	16	1/3



GN Tablett „GRANITE“

GN tray
GN bandeja
GN plateau



	cm	mm	GN
00923	53,0 x 16,2	16	2/4

MIRROR

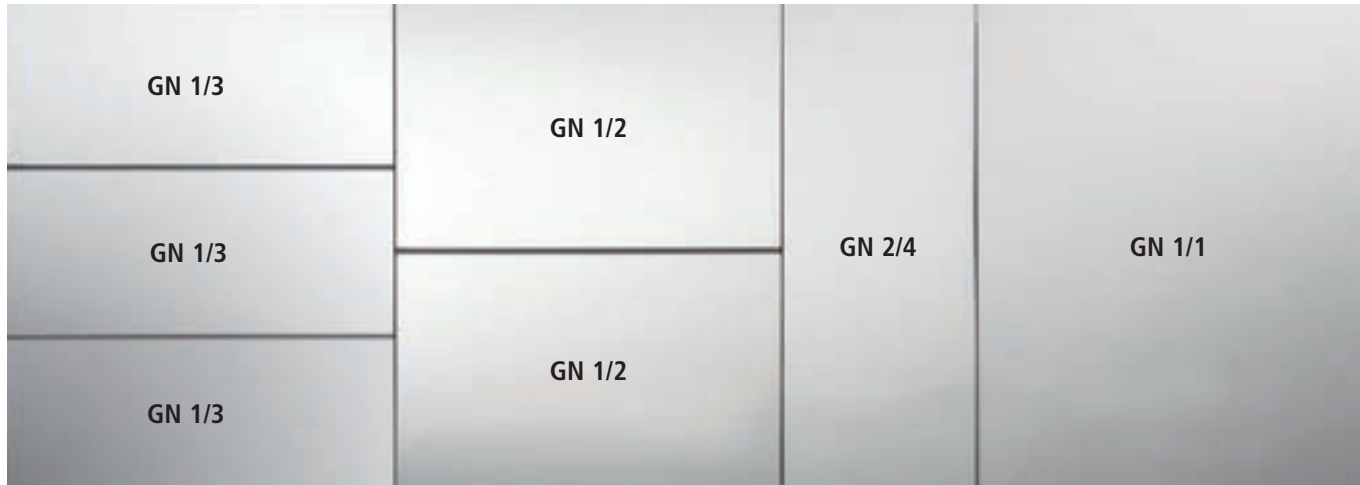

GN Glasplatte „MIRROR“

GN glass platter
GN espejos sobre vidrio
GN plateau miroir en verre



silber spiegelndes Glas, mit Antirutsch-Füßchen
silver mirror glas, non-slip feet
espejo plateado, pies antideslizantes
plateau miroir argenté, pieds antiglisse

	cm	↑ cm	GN
00961	53,0 x 32,5	3	1/1
00962	32,5 x 26,5	3	1/2
00963	32,5 x 17,6	3	1/3
00964	53,0 x 16,2	3	2/4

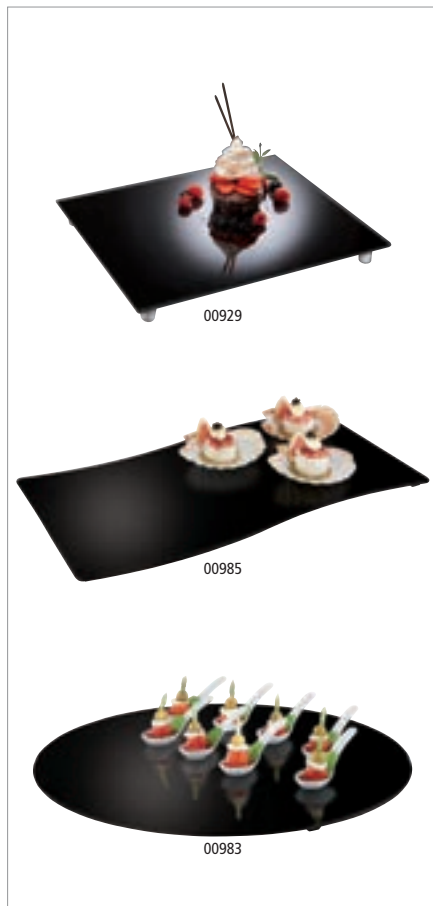

GN Glasplatte „MIRROR“

GN glass platter
GN bandeja espejo negro en vidrio
GN plateau miroir noir en verre



schwarz spiegelndes Glas, mit Antirutsch-Füßchen
black mirror glas, non-slip feet
bandeja espejo negro, pies antideslizantes
plateau miroir noir en verre, pieds antiglisse

	cm	↑ cm	GN
00929	53,0 x 32,5	3	1/1
00930	32,5 x 26,5	3	1/2
00931	32,5 x 17,6	3	1/3
00932	53,0 x 16,2	3	2/4

Welle / Wave / ola / vague

	cm	↑ cm	GN
00985	53 x 32,5	3	1/1

rund / round / redondo / rond

	Ø cm	↑ cm
00983	50	3

PROFI LINE

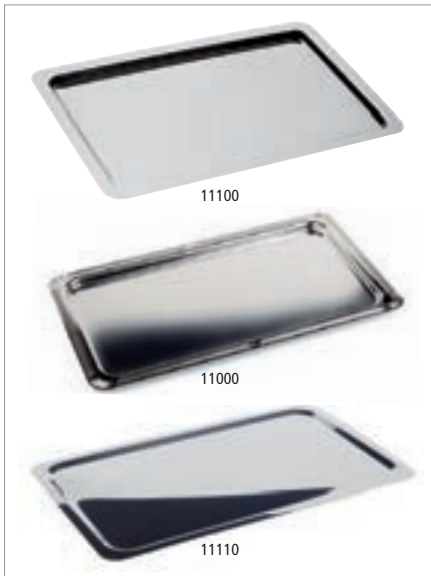

GN Edelstahl-Tablett „PROFI LINE“

GN tray
GN bandeja
GN plat empilable système catering



	cm	↑ cm	GN	
11100	53,0 x 32,5	1,5	1/1	mit glattem Rand / without decor-edge sin borde decorado / bords lisses
12100	32,5 x 26,5	1,5	1/2	mit glattem Rand / without decor-edge sin borde decorado / bords lisses
11000	53,0 x 32,5	1,5	1/1	mit Dekor-Rand / with decor-edge con borde decorado / bords avec relief
12000	32,5 x 26,5	1,5	1/2	mit Dekor-Rand / with decor-edge con borde decorado / bords avec relief
11110	53,0 x 32,5	1,0	1/1	glatter schmaler Rand / smooth narrow edge / borde estrecho liso / bord étroit lisse



GN Edelstahl-Behälter „PROFI LINE“

GN pan
GN cubeta
GN bac



	cm	↑ cm	GN	ltr.
11020	53,0 x 32,5	2,0	1/1	1,7
11040	53,0 x 32,5	4,0	1/1	3,4
11065	53,0 x 32,5	6,5	1/1	7,0
12040	32,5 x 26,5	4,0	1/2	2,0
12065	32,5 x 26,5	6,5	1/2	3,3



Fleisch- und Gemüseplatte „PROFI LINE“

tray
fuente de servicio
plat de service



Dekorrand hochglanzpoliert
decor edge mirror polished finish
borde decorado pulido efecto espejo
contour relief avec effet miroir

	Ø cm	↑ cm
11032	32	2,6
11038	38	2,6
11048	48	2,6



Fleisch- und Gemüseplatte „PROFI LINE“

tray
fuente de servicio
plat de service



Dekorrand hochglanzpoliert
decor edge mirror polished finish
borde decorado pulido efecto espejo
contour relief avec effet miroir

	cm	↑ cm
11023	50 x 36	2,6
11024	60 x 41	2,6
11025	70 x 46	2,6



Distanzstücke erhöhen die Nutzhöhe auf 8 cm

GN 1/1 System-Tablett „PROFI LINE“

GN 1/1 tray
GN 1/1 bandeja
GN 1/1 plateau empilable système catering



Dekorrand hochglanzpoliert, massive Griffe verchromt, inkl. fest verschraubten Distanzstücken, Nutzhöhe 4 cm
decor edge mirror polished finish, chrome plated handles, incl. mounted 4 cm distance pillars
borde pulido decorado, asas cromadas, incluye distanciadores a 4 cm
bords polis avec reliefs, poignées chromées, distance approx. 4 cm

	cm	GN
11300	53 x 32,5	1/1

8 cm Distanzstück 4 Stück, verchromt / 8 cm distance pillars 4 pcs., chrome plated / distanciadores a 8 cm, 4 piezas, plateado / 8 cm Kit réhausseur 4 pièce, chromée

11310	8 cm Distanzstücke können per Hand aufgeschraubt werden 8 cm distance pieces can be bolted by hand	
-------	---	--



Distanzstücke erhöhen die Nutzhöhe auf 8 cm

GN 1/1 System-Tablett „PROFI LINE“

GN 1/1 tray
GN 1/1 bandeja
GN 1/1 plat empilable système catering



Rand hochglanzpoliert, massive Bügelgriffe vergoldet, inkl. fest verschraubten Distanzstücken, Nutzhöhe 4 cm
mirror polished finish edge, gold plated handles, stackable approx. 4 cm
borde con acabado pulido, asas doradas, apilables aproximadamente 4 cm
contour effet miroir, poignées dorées, empilables distance 4 cm environ

	cm	GN
11290	53 x 32,5	1/1

8 cm Distanzstück-Set, 4 Stück, vergoldet / 8 cm distance pillars, 4 pcs., gold plated / distanciadores a 8 cm, 4 piezas, dorado / 8 cm kit réhausseur, 4 pièces, dorée

11252	8 cm Distanzstücke können per Hand aufgeschraubt werden 8 cm distance pieces can be bolted by hand	
-------	---	--



GN 1/1 System-Tablett „BUFFET-STAR“

GN 1/1 tray set
GN 1/1 set bandejas
GN 1/1 ensemble plateau



2-teilig: Tablett mit Griffen zum Stapeln + 1 Lochtablett mit 45 Löchern Ø 3,7 cm (Nr. 11170)
2 pcs. set: 1 tray with handles, stackable + 1 hole plate with 45 holes Ø 3,7 cm (No. 11170)
2 piezas: 1 bandeja con asas, apilable + 1 placa con 45 agujeros Ø 3,7 cm (No. 11170)
2 pièces: plateau 2 anses empilable + plaque 45 trous Ø 3,7 cm (No. 11170)

	cm	GN
11168	53 x 32,5	1/1



11150
mit verchromten Griffen

11155
mit vergoldeten Griffen

GN 1/1 System-Tablett „BUFFET-STAR“

GN 1/1 tray
GN 1/1 bandeja
GN 1/1 plateau empilable système catering



Rand hochglanzpoliert, inkl. fest verschraubten Griffen inkl. Distanzstücken, Nutzhöhe 4 cm
mirror polished finish edge, incl. screwed handles incl. distance pillars, 4 cm distance
borde pulido efecto espejo, incluye asas atornillables, distanciadores a 4cm
contour effet miroir, poignées à visser, distance approx. 4 cm

	cm	GN
11150	53 x 32,5	1/1

mit verchromten Griffen / with chrome plated handles / con asas cromadas / avec poignées chromées

11155	53 x 32,5	1/1	mit vergoldeten Griffen / with gold plated handles / con asas doradas / avec poignées dorées
-------	-----------	-----	--



System-Tablett „BUFFET-STAR“

system tray
bandeja del sistema
plat empilable système catering



Rand hochglanzpoliert, inkl. fest verschraubten Griffen inkl. Distanzstücken, Nutzhöhe 4 cm
mirror polished finish edge, incl. screwed handles incl. distance pillars, 4 cm distance
borde pulido efecto espejo, incluye asas atornillables, distanciadore a 4cm
contour effet miroir, poignées à visser, distance approx. 4 cm

	Ø cm	
11160	48	mit verchromten Griffen with chrome handles con asas cromadas / avec poignées chromées
11165	48	mit vergoldeten Griffen with gold plated handles con asas dorados / avec poignées dorées



GN 1/1 System-Tablett „CLASSIC“

GN tray
GN bandeja
GN plat empilable système catering



Rand hochglanzpoliert, mit fest verschraubten Griffen inkl. Distanzstücken, Nutzhöhe 3,5 cm
mirror polished finish edge, incl. screwed handles incl. distance pillars, 3,5 cm distance
borde pulido efecto espejo, incluye asas atornillables, distanciadore a 3,5cm
contour effet miroir, poignées à visser, distance approx. 3,5 cm

	cm	GN
11295	53 x 32,5	1/1



ideal für das platzsparende Servieren, Lagern und Transportieren
ideal for space-saving serving, storing and transporting



GN 1/1 System-Tablett „SWING“

GN tray
GN bandeja
GN plateau



Rand matt poliert, innen hochglanzpoliert, Nutzhöhe 4 cm, massive Griffe verchromt, inkl. fest verschraubten Distanzstücken
satin polished finish edge, stackable 4 cm, chrome handles, incl. screwed distance pillars
borde pulido efecto satinado, apilable 4 cm, asas cromadas, incl. distanciadore atorrillados
contour effet mat, empilable distance 4 cm, poignées chromées, incl. pièces à distance vissées

	cm	GN
01425	53,0 x 32,5	1/1



ideal für das platzsparende Servieren, Lagern und Transportieren
ideal for space-saving serving, storing and transporting



Tablett „SWING“

tray
bandeja
plateau



Rand matt poliert, innen hochglanzpoliert
satin polished finish edge, inside mirror polished finish
borde pulido efecto satinado, interior pulido efecto espejo
contour effet mat, intérieur poli miroir

	cm	↑ cm	GN
01416	32,5 x 32,5	1	
01415	28,5 x 20,0	1	
01420	53,0 x 32,5	1	1/1



GN 1/1 Buffet-Set „CATERER“

GN 1/1 buffet set
GN 1/1 set de bufé
GN 1/1 set catering: plateau + cloche



2-teilig: Tablett + Haube, Tablett fixiert sich auf der Haube - kein Rutschen möglich
2 pcs. set: tray + cover, tray fixes itself on the cover and can not slip off
set de 2 piezas: bandeja + tapa, la bandeja encaja encima de la tapa para que no se deslice
ensemble de 2 pièces: plateau GN 1/1 réf. + cloche spéciale empilement stable

	cm	↑ cm	GN
11195	53 x 32,5	10,5	1/1



GN 1/1 Buffet-Set „HOCHSTAPLER“

GN 1/1 buffet set
GN 1/1 set de bufé
GN 1/1 kit catering plateau + cloche



2-teilig: Tablett + Haube, Tablett fixiert sich auf der Haube - kein Rutschen möglich
2 pcs. set: tray + cover, tray fixes itself on the cover and can not slip off
2 piezas: bandeja + tapa la bandeja se fija a la tapa para que no se deslice
2 pièces: plateau réf. + cloche spéciale empilement stable

	cm	↑ cm	GN
11302	53 x 32,5	10,5	1/1



GN 1/1 Haube „HOCHSTAPLER“

GN 1/1 cover
GN 1/1 campana
GN 1/1 cloche



glasklarer Kunststoff, Tablett fixiert sich auf der Haube - kein Rutschen möglich, nahezu bruchfest
clear plastic, tray fixes itself on the cover and can not slip off, nearly unbreakable
plástico transparente, la bandeja se fija a la tapa para que no se deslice, muy resistente a la rotura
en plastique transparen, le plat se fixe sur le dessous de la cloche pour ne pas glisser, très résistant à la casse

	cm	↑ cm	GN	fits to
11305	53 x 32,5	9	1/1	11300, 11290, 11295



GN Abdeckhaube

GN cover
GN cubierta
GN cloche



	cm	↑ cm	✱ mm	GN
11041	32,5 x 26,5	9,5	3	1/2
11042	53,0 x 32,5	9,5	3	1/1



GN Tablett „SUNDAY“

GN tray
GN bandeja
GN plateau



hochglanzpoliert
mirror polished finish
acabado espejo pulido
effet brillant

	cm	↑ cm	GN
11220	53,0 x 32,5	2	1/1
11210	32,5 x 26,5	2	1/2



Tablett „SUNDAY“

tray
bandeja
plateau



hochglanzpoliert
mirror polished finish
acabado espejo pulido
effet brillant

	Ø cm	↑ cm
11211	46	2



GN Tablett „SUNDAY“

GN tray
GN bandeja
GN plateau



hochglanzpoliert, Griffe inkl. Fixierung, kein Verrutschen möglich, Nutzhöhe 4 cm
pulido espejo, con 2 asas para apilado muy estable, distancia 4 cm entre bandejas
effet brillant, 2 anses pour empilement très stable, distance 4 cm entre plateaux

	cm	↑ cm	GN
11222	53,0 x 32,5	6	1/1
11212	32,5 x 26,5	6	1/2

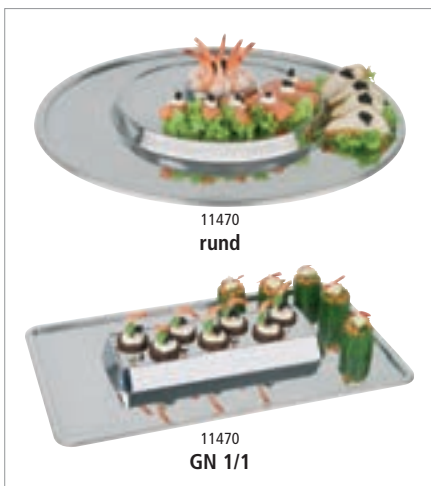

Buffet-Tablett

buffet-tray
bandeja de bufé
plateau buffet



Die mehrstufigen Buffet-Tablets sind tolle Blickfänge auf jedem Buffet. Sind einfach zu dekorieren und werden zum echten Hingucker.
perfect for the buffet and party service
perfecta para el servicio de bufé y fiesta
idéal pour buffets et catering

	Ø cm	↑ cm
11470	48	4,5

	cm	↑ cm	GN
11475	53,0 x 32,5	3,5	1/1



Tablett „SCHÖNER ESSEN“

tray
bandeja
plateau



cm		
00383	35,0 x 24,0	
00382	42,0 x 31,0	
00381	50,0 x 36,0	
00384	63,5 x 44,5	
00385	60,0 x 40,0	
cm		
03824	42,0 x 31,0	leichte Ausführung 0,5 mm / extra light model 0,5 mm modelo extraligero 0,5 mm / qualité légère, ép. 0,5 mm
03814	50,0 x 36,0	leichte Ausführung 0,5 mm / extra light model 0,5 mm modelo extraligero 0,5 mm / qualité légère, ép. 0,5 mm



GN 1/1 Tablett „SCHÖNER ESSEN“

GN tray
GN bandeja
GN plateau



cm	GN
00388	53,0 x 32,5 / 1/1



Tablett „SCHÖNER ESSEN“

tray
bandeja
plateau



mit Dekorrand, Griffe Zinkdruckguss verchromt, genietet
with decor edge, handles zinc alloy chrome plated, riveted
borde decorado, asas fundición con zinc
bord décor, poignées en fonte zinguée

cm	
00082	52 x 31,0
00081	60 x 36,0
00084	75 x 44,5



Fleisch-/Gemüseplatte „SCHÖNER ESSEN“

meat / vegetable platter
plato de carne / verduras
assiette de viande / légumes



cm		
00087	38 x 23	rechteckig, abgerundet / rectangular, rounded edge rectangular / rectangulaire



Fleisch-/Gemüseplatte „SCHÖNER ESSEN“

meat / vegetable platter
plato de carne / verduras
assiette de viande / légumes



cm	
00089	50 x 39,5



Tablett „SCHÖNER ESSEN“

tray
bandeja
plateau



	Ø cm	
00075	31	
00085	35	



Tablett mit Haube „SCHÖNER ESSEN“

tray with cover
bandeja con cubierta
plateau avec cloche



	cm	↑ cm
38202	42 x 31	8,0

Haube / cover / campana / cloche

	cm	↑ cm
08201	36,5 x 26,0	7,5



GN 1/1 Tablett „STAR“

GN tray
GN bandeja
GN plateau



Rand hochglanzpoliert mit Prägung
polished decor edge
borde pulido decorado
bords polis miroir, avec relief sur les petits côtés

	cm	GN
11115	53 x 32,5	1/1



griffig, keine Fingerabdrücke sichtbar, Randprägung auf kurzen Seiten
catchy, fingerprints are not visible, edge lettering on the short sides



GN 1/1 Buffet-Tablett „HALBMOND“

GN tray
GN bandeja
GN plat demi-lune



mit klassischem Linienprägededor, passend für Thermoboxen GN 1/1 und Thermoporte
with decor edge, usable in thermoboxes GN 1/1
con borde decorado, apto para cajas térmicas GN 1/1
bords avec relief, apte pour conteneurs GN 1/1

	cm	GN
11111	53 x 32,5	1/1



hot price

Edelstahl-Schale

bowl
bandeja ovalada inox
corbeille ovale inox



eingerollter Rand
rolled edge
borde redondeado
bord roulé

	cm	↑ cm
40110	26,5 x 18,5	4,0
40115	31,0 x 21,0	4,5



01311

Tablett „FINESSE“

tray
bandeja
plateau



	cm	
01314	30 x 24	
01313	35 x 24	
01317	39 x 26	
01312	42 x 31	
01318	48 x 30	
01311	50 x 38	
01310	58 x 42	
01309	68 x 48	



01338

Tablett „FINESSE“

tray
bandeja
plateau



	Ø cm	
01332	32	
01335	35	
01338	38	
01348	48	
01349	48,5	
01358	58	



01324

Tablett „FINESSE“

tray
bandeja
plateau



	cm	
01322	42 x 30	
01323	50 x 36	
01324	60 x 41	
01325	70 x 46	



01738

Tablett „FINESSE“

tray
bandeja
plateau



verchromte Messing-Griffe
chrome plated brass handles
asas plateadas de latón
poignées en laiton chromées

	cm	
01723	51 x 36	oval / oval / ovalada / ovale
01725	71,5 x 46	oval / oval / ovalada / ovale
	Ø cm	
01738	38	rund / round / redondo / rond
01748	48	rund / round / redondo / rond



Tablett „FINESSE“

tray
bandeja
plateau

verchromte Messing-Griffe
chrome plated brass handles
asas de latón cromadas
poignées en laiton chromées



	cm	
01712	44 x 31	
01711	52 x 38	
01710	60 x 42	
01709	70 x 48	



Tablett mit Haube „FINESSE“

tray with cover
bandeja con campana
plateau avec cloche



	cm		↑ cm
13122	42 x 31		8,5



Tablett mit Haube „FINESSE“

tray with cover
bandeja con campana
plateau avec cloche



	Ø cm	↑ cm
13622	22	9,5



Tablett mit Haube „FINESSE“

tray with cover
bandeja con cubierta
plateau avec cloche



	Ø cm	↑ cm
13382	38	12
13385	38	13



Edelstahltablett

tray
bandeja
plateau



	cm		↑ cm
09010	43,5 x 32,5		1,5

Rolltophaube „PURE“ / rolltop cover / campana abatible / cloche basculante

	cm		↑ cm
09013	44 x 33,5		17



Tablett „ELEGANCE“

tray
bandeja
plateau



	cm	
02310	41 x 26	
02311	48 x 30	
02312	60 x 37	



Tablett mit Haube „ELEGANCE“

tray with cover
bandeja con cubierta
plateau avec cloche



	cm	↑ cm
23642	35 x 19	10



Serviertablett „FLASH“

tray
bandeja
plateau

	cm	↑ cm
00064	34 x 16,5	10
00067	25 x 19	7

Haube für 00064 / cover for 00064 / campana para 00064 / cloche pour 00064

06401

Haube für 00067 / cover for 00067 / campana para 00067 / cloche pour 00067

06701



Tortenplatte mit Haube

cake plate with cover
bandeja tarta con campana
plat à tarte avec cloche



	Ø cm	↑ cm	
00065	30	11	mit 1 Haube / with 1 cover
00652	30	7 + 11	mit 2 Hauben / with 2 cover



Tortenplatte „BAROK“

cake plate
bandeja tartas
plat à gâteau



2-teilig: Tortenplatte mit Barock-Rand + Haube (extra stabil)
2 pcs. set: cake plate with decor edge „Barok“ + cover (extra robust)
set 2 piezas: porta tartas, borde decor „Barok“ + campana (extra fuerte)
set 2 pcs: plateau bord décor „Barok“ + cloche ultra-résistante

	Ø cm	↑ cm
06503	32	10

Frischhalte-Haube / cover / campana / cloche

	Ø cm	↑ cm
06510	30	11,5

PARTYPLATTEN

Nicht säure- und spülmaschinenfest, Lebensmittel nur mit Papierdeckchenunterlage servieren.

Non-acid and dishwasher-proof, serve food only with paper tray covers.

No resistente a los ácidos y al lavavajillas, servir alimentos sólo con papel para bandeja party.

Pas résistant aux acides et au lave-vaisselle, servent la nourriture seulement avec papier dentelles.



Warenträger

display
expositor
présentoir

für Partyplatten

- platzsparende flexible Präsentation durch geringe Abmessungen
- als Zweitplatzierung für Ihre zusätzlichen Umsätze
- in weiß lieferbar

for partytrays- space saving presentation- small size- available in white
para bandejas Party, ocupa poco espacio, disponible en blanco
pour plateaux Party, occupe très peu d'espace, disponible en blanc

	cm	↑ cm
00397	55 x 65	190



Partyplatte „CLASSIC“

partytray
bandeja party
plateau party



mit Liniendekor, Rand eingerollt

with line decor, rolled edge
con filos en relieve
avec décoration lignée, bord rond

	cm	VE / unit	GN
00395	53,0 x 32,5	36	1/1
00399	41,0 x 31,0	48	
00389	35,4 x 32,5	48	2/3



Partyplatte „CLASSIC“

partytray
bandeja party
plateau party



mit Liniendekor, Rand eingerollt

with line decor, rolled edge
con filos en relieve
avec décoration lignée, bord rond

	Ø cm	VE / unit
00396	35	48



Partyplatte „CLASSIC“

partytray
bandeja party
plateau party



mit Liniendekor, Rand eingerollt

with line decor, rolled edge
con filos en relieve
avec décoration lignée, bord rond

	cm	VE / unit
00398	46,0 x 34,0	48

hot price



Partyplatte
partytray
bandeja party
plateau party



Innenfläche ziseliert, Rand eingerollt
rolled edge, decorated surface
borde redondeado, superficie totalmente decorada
bord rond, surface entièrement ciselée

	Ø cm	VE / unit
00393	35	48

hot price



Partyplatte
partytray
bandeja party
plateau party



Innenfläche ziseliert, Rand eingerollt
rolled edge, decorated surface
borde redondeado, superficie totalmente decorada
bord rond, surface entièrement ciselée

	cm	VE / unit
00391	46 x 34	48

hot price



Partyplatte
partytray
bandeja party
plateau party



Innenfläche ziseliert, Rand eingerollt
rolled edge, decorated surface
borde redondeado, superficie totalmente decorada
bord rond, surface entièrement ciselée

	cm	VE / unit
00392	41 x 31	48

hot price



GN 1/1

GN 1/1 Partyplatte
GN partytray
GN bandeja party
GN plateau party



Innenfläche ziseliert, Rand eingerollt
rolled edge, decorated surface
borde redondeado, superficie totalmente decorada
bord rond, surface entièrement ciselée

	cm	VE / unit	GN
00394	53 x 32,5	36	1/1



Serviertablett „KAFFEEHAUS“

tray
bandeja
plateau



	cm	↑ cm	Farbe / Colour
84250	26,0 x 20,0	1,5	White
84252	28,5 x 21,5	1,5	White
84251	26,0 x 20,0	1,5	Black
84253	28,5 x 21,5	1,5	Black



Serviertablett „KAFFEEHAUS“

tray
bandeja
plateau



Innenfläche ziseliert, Rand eingerollt
rolled edge
borde redondeado, superficie decor relieve
bord rond, surface entièrement ciselée

	cm	pcs.
30114	30 x 22	48



Serviertablett „KAFFEEHAUS“

tray
bandeja
plateau



matt poliert, Rand eingerollt
satin polished finish, rolled edge
acabado pulido satinado, borde redondeado
effet satin mat, bord rond

	cm	↑ cm
30119	23 x 23	1,5



Serviertablett „KAFFEEHAUS“

tray
bandeja
plateau



matt poliert, Rand eingerollt
satin polished finish, rolled edge
acabado pulido efecto satinado, borde redondeado
effet satin, bord rond

	cm	↑ cm
30118	21,5 x 13	1,5

mattiert
satin polished finish



30126



30136

hochglanzpoliert
mirror polished finish

Serviertablett „KAFFEEHAUS“

tray
bandeja
plateau



	cm	↑ cm	
30126	25,5 x 19,5	2	mattiert / satin polished finish acabado efecto satinado / fini mat effet satin
30127	30 x 23	2	mattiert / satin polished finish acabado efecto satinado / fini mat effet satin
30136	25,5 x 19,5	2	hochglanzpoliert / mirror polished finish acabado espejo pulido / poli brillant miroir
30137	30 x 23	2	hochglanzpoliert / mirror polished finish acabado espejo pulido / poli brillant miroir

matt poliert
satin polished finish



30112

Serviertablett „KAFFEEHAUS“

tray
bandeja
plateau



matt poliert, oval, Rand eingerollt
satin polished finish, oval, rolled edge
pulido acabado efecto satinado, oval, borde redondeado
effet satin, ovale, bord rond

	cm	↑ cm	
30111	19 x 15	1	für Zucker und Sahne / for sugar and cream para azúcar y crema / pour le sucre et la crème
30112	26,5 x 19	1	für eine Tasse / for one cup para una taza / pour une tasse
30113	29 x 22	1	für zwei Tassen / for two cups para dos tazas / pour deux tasses
30123	23 x 17,5	1	Eisdielen-Größe / icecream pralor size tamaño especial para heladerías / taille spéciale pour glaciers

hochglanzpoliert
mirror polished finish



30116

Serviertablett „KAFFEEHAUS“

tray
bandeja
plateau



hochglanzpoliert, oval, Rand eingerollt
mirror polished finish, oval, rolled edge
pulido efecto espejo, ovalado, borde redondeado
effet brillant, ovale, bord rond

	cm	↑ cm	
30115	19 x 15	1	für Zucker und Sahne / for sugar and cream para azúcar y crema / pour le sucre et la crème
30116	26,5 x 19	1	für eine Tasse / for one cup para una taza / pour une tasse
30117	29 x 22	1	für zwei Tassen / for two cups para dos tazas / pour deux tasses
30124	23 x 17,5	1	Eisdielen-Größe / icecream pralor size tamaño especial para heladerías / taille spéciale pour glaciers

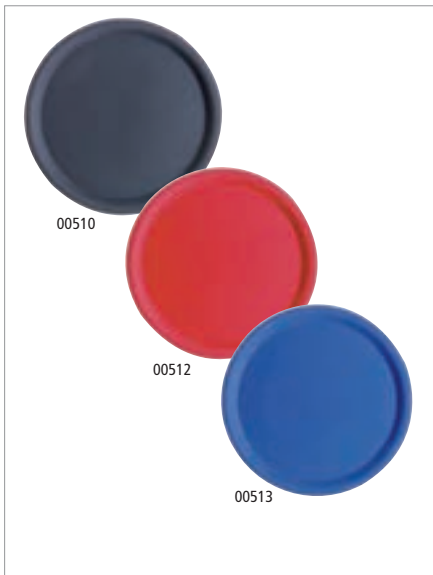

Serviertablett „HAPPY HOUR“

tray
bandeja
plateau



rutschfeste Oberfläche
non-slip surface
superficie anti-deslizante
surface antidérapante

	Ø cm	↑ cm	Farbe / Colour
00510	32	1,5	■
00511	38	1,5	■
00515	43	1,5	■
.....			
	Ø cm	↑ cm	Farbe / Colour
00512	38	1,5	■
00513	38	1,5	■



Tablett „GASTRO“

tray
bandeja
plateau



rutschfeste Oberfläche
non-slip surface
superficie anti-deslizante
surface antidérapante

	Ø cm	↑ cm	Farbe / Colour
00547	27,5	2	■
00548	35,5	2	■
00549	40,5	2	■



Tablett „BISTRO“

tray
bandeja
plateau



rutschfest, mit 2 Griffmulden und Stapelrand
non-slip, two open handles, stackable edge
anti-deslizante, 2 asas
antidérapant, 2 anses

	Ø cm	↑ cm	Farbe / Colour
84045	35,5	4,5	■



Bierglasträger „RUTSCHFEST“

beer rack
bandeja para cerveza
porte verre à bière



rutschfeste Oberfläche
non-slip surface
superficie anti-deslizante
surface antidérapante

	Ø cm	↑ cm	Farbe / Colour	
00500	36	3,5	■	rund / round
00501	36	3,5	■	rund / round
.....				
	cm	↑ cm	Farbe / Colour	
00506	28 x 20	1,5	■	oval
00507	28 x 20	1,5	■	oval



Serviertablett „FLASH“

tray
bandeja
plateau



rutschfeste Oberfläche
non-slip surface
superficie antideslizante
surface antidérapante

	Ø cm	↑ cm	
00550	35,5	2	schwarz / weiß / black / white



Serviertablett „COOL“

tray
bandeja
plateau



rutschfeste Oberfläche
non-slip surface
superficie antideslizante
surface antidérapante

	Ø cm	↑ cm	
00551	35,5	2	weiß / schwarz / braun / white / black / brown



Serviertablett „RUTSCHFEST“

tray non-slip
bandeja antideslizante
plateau antiglisse



rutschfeste Oberfläche
non-slip surface
superficie anti-deslizante
surface antidérapante

	cm	↑ cm	GN	Farbe / Colour
00502	53,0 x 32,5	1,5	1/1	■
00508	46,0 x 36,0	2		■
00505	53,0 x 32,5	1,5	1/1	■
00503	53,0 x 37,0	1,5		■



Tablett

tray
bandeja
plateau



rutschfest, Holzdekor-Laminat
non-slip, coated wood
antideslizante
antidérapant

	cm	↑ cm
00524	43,5 x 31,5	1,5
00525	52,0 x 39,0	1,5
00526	60,5 x 42,5	1,5



Fast Food-Tablett

snack tray
bandeja autoservicio y snacks
plateau self-service et snacks



	cm	↑ cm	GN	Farbe / Colour
00530	35 x 27	2		Red
00535	41 x 30,5	2		Red
00540	45 x 35,5	2		Red
00552	53,0 x 32,5	2	1/1	Red

	cm	↑ cm	GN	Farbe / Colour
00531	35 x 27	2		Black
00536	41 x 30,5	2		Black
00541	45 x 35,5	2		Black
00553	53,0 x 32,5	2	1/1	Black

	cm	↑ cm	GN	Farbe / Colour
00532	35 x 27	2		Brown
00537	41 x 30,5	2		Brown
00542	45 x 35,5	2		Brown
00554	53,0 x 32,5	2	1/1	Brown

	cm	↑ cm	GN	Farbe / Colour
00533	35 x 27	2		Light Grey
00538	41 x 30,5	2		Light Grey
00543	45 x 35,5	2		Light Grey
00555	53,0 x 32,5	2	1/1	Light Grey



Tablett

tray
bandeja
plateau



rutschfest, Mahagonifurnier
non-slip, woodform, mahogany
antideslizante
antidérapant

	Ø cm	↑ cm	
00528	31	3,5	hoher Rand
00529	35,5	3,5	hoher Rand
00527	32	1,5	flacher Rand



Tablett

tray
bandeja
plateau



rutschfest, Holzdekor-Laminat
non-slip, coated wood
antideslizante
antidérapant

	cm	↑ cm
00520	23,0 x 16,0	1,0
00521	26,0 x 20,0	1,0
00522	29,0 x 21,0	1,0
00523	38,0 x 27,0	1,5



Rechnungstablett, 2er Set

bill presenter, 2 pcs. set
 porta cuenta, set de 2 unidades
 porte-addition, set de 2 pièces



1 Edelstahl-Tablett hochglanzpoliert + 1 klappbare Ledermappe mit Stifflasche, mit Magnethalterung

1 stainless tray mirror polished finish + 1 leather presenter, with magnetic system
 1 bandeja de acero inoxidable pulido brillante + 1 presentador de cuero con sistema magnético
 1 plateau inox poli brillant + 1 pochette cuir aimantée

	cm	↑ cm
30109	20 x 16	2



Rechnungstablett

bill presenter
 porta cuenta
 porte-addition



mit Klemme für Rechnung

with clip for bill
 con clip para la nota
 avec clip pour la note

	cm	↑ cm
30108	20,0 x 12,0	0,5



Rechnungstablett

bill tray
 bandeja porta-cuenta
 plateau addition



mit Klemme für Rechnung

with clip for bill
 con clip para la nota
 avec pince

	cm	↑ cm
30110	17 x 11	1



Untersetzer

coaster
 posavasos
 plateau sous-verre



hochglanzpoliert, schwere Ausführung, Rand eingerollt
 mirror polished finish, heavy quality, rolled edge
 acabado pulido efecto espejo, alta calidad, borde redondeado
 effet miroir, bord rond, qualité extra

	Ø cm	pcs.
35711	10	6
35912	12	6

35912

Rand eingerollt

Buffet & Service



Tablett

tray
bandeja
plateau

mit gebördeltem, polierten Rand
rolled and mirror polished edge
borde redondeado acabado efecto espejo
bord rond, effet miroir



	Ø cm	↑ cm	
01336	35	3	



Buffetständer

buffet stand
soporte bufé
support buffet



	Ø cm	↑ cm	fits to
74207	20 - 25	19	01336



Bratenplatte „ECO LINE“

meat platter
fuente servicio
plat de service

poliert, Rand eingerollt
polished, rolled edge
pulido, borde redondeado
poli miroir, bord rond



	cm
30101	30 x 22
30102	35 x 22
30103	40 x 26
30104	45 x 30



Servierpfanne

pan
fuente para la mesa
plat pour la table

mit vergoldeten Edelstahl-Griffen, 1 mm dick
with gold plated handles, 1 mm thickness
grosor 1 mm., asas doradas
épaisseur 1 mm, poignées dorées



	Ø cm	↑ cm	litr.
61400	40	5	4,5
61190	19	3,5	0,7
61280	28	4	2



Servierpfanne

pan
fuente para la mesa
plat pour la table

mit vergoldeten Edelstahl-Griffen, 1 mm dick
with gold plated handles, 1 mm thickness
grosor 1 mm., asas doradas
épaisseur 1 mm, poignées dorées



	cm	↑ cm	litr.
60270	26,5 x 19,5	3	0,8
60310	31 x 21,5	3	1,2



Buffetbrett „FISCH“

board
tabla para el bufé
planche à découper buffet



Buchenholz, mit Antirutsch-Füßchen

beech wood, with non-slip feet
haya, pies antideslizantes
hêtre, pieds antidérapants

	cm	↑ cm
00860	76 x 23	2,5



Fischplatte „BIG“

fish plate
fuente para pescado
plat creux à poisson



Fisch-Optik auf der Innenseite

fish-look inside
aspecto pez en el interior
aspect poisson à l'intérieur

	cm	↑ cm
83996	58,5 x 28,0	5,5



Tablett „TIMBER“

tray
bandeja
plateau



die Melaminplatten (Holzoptik Fichte) haben eine leichte Struktur und wirken optisch wie aus Holz gefertigt

superb spruce wood effect (timber), cutting edge gourmet presentation idea, never produce mould or sawdust, clean and hygienic, no more worries about crack

melamina imitación madera de picea, para recetas auténticas
mélangine imitation spruce, pour vos recettes authentiques

	cm	↑ cm
84269	65 x 26	3



Tablett „OAK LIGHT“

tray
bandeja
plateau



die Melaminplatten (Holzoptik Eiche) haben eine leichte Struktur und wirken optisch wie aus Holz gefertigt

superb oak wood effect, cutting edge gourmet presentation idea, never produce mould or sawdust, clean and hygienic, no more worries about crack

melamina imitación madera de roble, para recetas auténticas
mélangine imitation chêne, pour vos recettes authentiques

	cm	↑ cm
84265	65 x 26	3



Servier- / Tortenplatte

cake stand
soporte para pastel
présentoir à gâteaux



hochglanzpoliert, mit hohem Fuß (fest verbunden)
mirror polished finish, with tall foot
acabado brillante, con pie alto
poli brillant, pied haut

	Ø cm	↑ cm
00466	34,5	13,5



Servier- / Tortenplatte

cake stand
soporte para pastel
présentoir à gâteaux



Fuß hochglanzpoliert, Platte matt poliert, stabil und sehr standsicher
foot mirror polished finish, plate satin polished finish
pie pulido brillante, bandeja pulida mate
pied brillant, plateau poli satin mat

	Ø cm	↑ cm
00462	30	11



Servier- / Tortenplatte

cake stand
soporte para pastel
présentoir à gâteaux



matt poliert, drehbar, möbelschonende Moosgummi-Unterseite
satin polished finish, rotating, foam rubber below to save your furniture
acabado pulido satinado, giratorio, base revestida de goma para no rallar el mobiliario
poli satiné, plateau tournant, revêtement mousse sous le pied pour ne pas rayer les meubles

	Ø cm	↑ cm
00463	30,5	9



Servier- / Tortenplatte

cake stand
soporte para pastel
présentoir à gâteaux



Fuß matt poliert, stabil und sehr standsicher, möbelschonende Moosgummi-Unterseite
foot satin polished finish, foam rubber below to save your furniture
pie pulido con efecto satinado, base revestida de goma para no rallar el mobiliario
inox poli satin, revêtement mousse sous le pied pour ne pas rayer les meubles

	Ø cm	↑ cm
00464	30	11

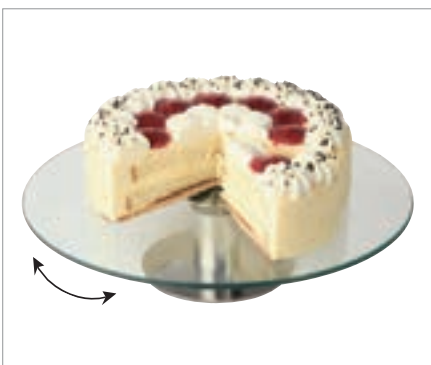

Servier- / Tortenplatte

cake stand
soporte para pastel
présentoir à gâteaux



Fuß matt poliert, drehbar, möbelschonende Moosgummi-Unterseite
foot satin polished finish, rotating, foam rubber below to save your furniture
vidrio, pie inox satinado giratorio, base de goma para proteger el mobiliario
plateau en verre, pied tournant inox poli satin, revêtement mousse sous le pied anti-rayures

	Ø cm	↑ cm
00444	30	7

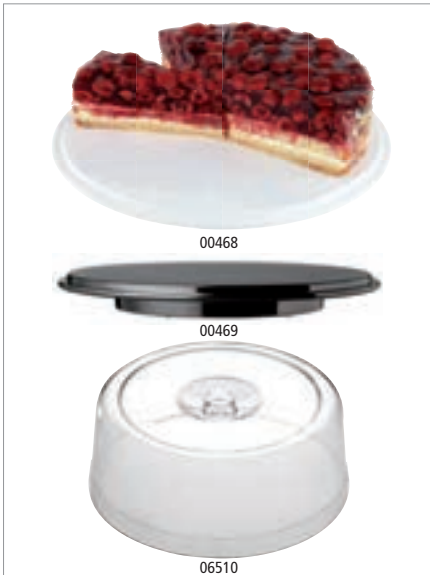

Torten- / Konditorplatte

cake stand
soporte para pastel
présentoir à gâteaux



Rand fixiert die Haube, mit Antirutsch-Füßchen

carved edge fixes the cover, non-slip feet
ranura para fijar bien la campana, pies antideslizantes
bord rainuré pour maintenir ferme la cloche, pieds antiglisse

	Ø cm	↑ cm	Farbe / Colour
00468	31	4	White
00469	31	4	Black

Frischhalte-Haube / cover / campana / cloche

	Ø cm	↑ cm
06510	30	11,5



Konditorplatte

cake stand
soporte para pastel
présentoir à gâteaux



matt poliert

satin polished finish
acabado efecto satinado
poli mat effet satin

	Ø cm	↑ cm
00046	31	3



Kaviarkühler

caviar cooler
enfriador de caviar
rafraîchisseur de caviar



4-teilig: Glasschale Ø 10 cm
4 pcs.: glass bowl Ø 10 cm
4 piezas: bol Ø 10 cm
4 éléments: bol Ø 10 cm

	Ø cm	↑ cm
01699	18	12



Kühlschale, 2-teilig „COOL“

cool bowl, 2 pcs. set
cuenco refrigerado, 2 pz.
set de 2 bols réfrigérés



2-teilig, doppelwandig, Schale ist mit Kühlmittel gefüllt und wird zum Aufladen in das Gefrierfach gelegt, endlos verwendbar

2 pcs., 1 pc. double wall ice bowl filled with freezer-liquid, 1 pc. stainless bowl
bol isotérmico, doble pared que contiene un líquido refrigerante, acumula el frío en el congelador para luego mantener fríos los alimentos, para usos repetitivos
bol isotherme, double paroi qui contient un liquide réfrigérant, accumule le froid du congélateur pour ensuite maintenir froids les aliments, pour usages répétés

	Ø cm	↑ cm	ltr.
30023	23	10,5	1

Deckel „FLOAT“ mit Löffelaussparung / cover, with notched for spoons / tapa, con espacio para la cuchara / couvercle, avec encoche pour la louche

	Ø cm	↑ cm
83920	20,5	1,3



30040

Edelstahlschale, doppelwandig

stainless bowl, double wall
bol inox doble pared
bol inox double paroi



beste Isoliereigenschaften
best insulating properties
muy aislante
très isolant

	Ø cm	↑ cm	litr.
30040	14	6,5	0,5
30041	20	9	1,5
30042	23	10	2,5



Dressingtopf, doppelwandig

bowl, double wall
salsera alta, doble pared
pot à sauce, double paroi



beste Isoliereigenschaften
best insulating properties
muy aislante
très isolant

	Ø cm	↑ cm	litr.
30043	15	18	1,8



Dressingtopf

dressing pot
salsera
pot à sauce



Deckel mit Löffelaussparung
cover notched for spoon
tapa agujereada para el cucharón
couverture avec espace pour la louche

	Ø cm	↑ cm	litr.
83309	18,5	17	2,3
83310	17	15	2,0
83311	13	13	0,8



83867

83868

Dressingtopf „CASUAL“

dressing pot
salsera
pot à sauce



	cm	↑ cm	litr.	Farbe / Colour
83867	12	21,5	1	White
83868	12	21,5	1	Black



Kühlkaraffe, 3-teilig „COOL“

cooling carafe, 3 pcs. set
jarra fría, set de 3 piezas
pichet rafraîchisseur, set 3 pièces



1 Glaskaraffe mit Edelstahl-Ausgießer, öffnet und schließt selbstständig + 1 verchromter Fuß
+ 1 Kühlakku, Getränke werden bis zu 4 Stunden gekühlt

1 glass carafe with stainless steel pourer, open / closing autonomous + 1 chrome plated base + 1 cooling pack, up to 4 hours cooled beverages

1 botella de vidrio con vertedor inox y silicona, con autocierre + 1 base cromada + 1 placa de frío que mantiene las bebidas frescas hasta unas 4 horas

pichet en verre avec insert verseur inox et silicone, fermeture automatique + socle chromé + accumulateur de froid pour maintenir les boissons froides jusqu'à 4 heures

	Ø cm	↑ cm	ltr.
10762	16	27	1,4

Glasflasche / glass carafe / jarra de vidrio / pichet verre

	Ø cm	↑ cm
10761	16	26

Kühlakku rund, schwarz / cooler round, black / cooler / accumulateur de froid, noir

	Ø cm	↑ cm
10752	10,5	2,0



Glaskaraffe

glass carafe
jarra
pichet verre



Deckel aus Edelstahl
stainless steel cover
tapa de acero inoxidable
couvercle inox

	Ø cm	↑ cm	ltr.
10764	9,5	27	1,5



Ausgießer für tropffreies Servieren
spout for drip-free pouring

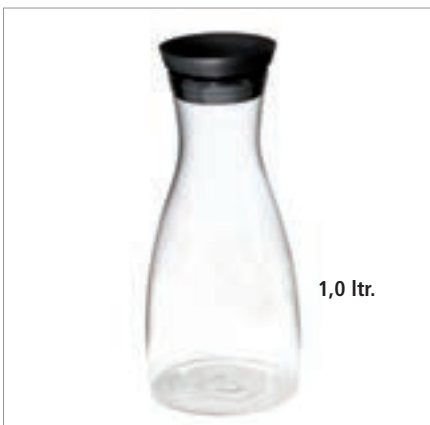

Glaskaraffe

glass carafe
jarra
pichet en verre



der Deckel öffnet sich beim Ausgießen automatisch
cover opens automatically while pouring
la tapa se abre automáticamente durante el vertido
le couvercle s'ouvre seul pendant le service, résistant à la chaleur

	Ø cm	↑ cm	ltr.
10766	9,5	29	1



Kanne

pitcher
jarra
pichet



mit transparentem Deckel, ideal für Milch
included transparent cover, perfect for milk
tapa transparente, perfecto para leche
couvercle transparent, pour lait

	Ø cm	↑ cm	ltr.
84225	14	21	2



1,8 ltr.

Saftkanne

juice pitcher
jarra de zumo
pichet à jus de fruit



inklusive Stift (schwarz) zum Beschriften, Beschriftung lässt sich leicht entfernen (Kanne wird unbeschriftet geliefert)

marker (black) included, marking can be easily removed (pitcher is not marked)
rotulador incluido, fácil de borrar (se entrega sin ningún texto marcado)
marqueur inclus, facile à effacer (livraison sans texte écrit)

	Ø cm	↑ cm	ltr.
10753	12	24	1,8

Stift / marker / rotulador / marqueur

10787 Strichstärke Medium = ca.1 mm, Schreibfarbe schwarz, non-permanent, feucht abwischbar, farbintensiv, schnelltrocknend, zum Beschriften von: Papier, Kunststoff, Glas, Metall



2,0 ltr.

Kanne „ICEBLUE“

pitcher
jarra
pichet



mit transparentem Deckel
included transparent cover
tapa transparente
couvercle transparent

	Ø cm	↑ cm	ltr.
10754	12	26	2



2,8 ltr.

Saft- / Wasserkanne

juice / water pitcher
jarra de zumo / agua
pichet à eau ou jus de fruit



mit Eiswasser-Röhre
with water ice tube
con tubo para hielo
avec tube à glaçons plongeant pour réfrigérer

	cm	↑ cm	ltr.
10769	19 x 13	27	2,8



3,0 ltr.

Saftkanne

juice pitcher
jarra de zumo
pichet à jus de fruit



mit Eiswasser-Röhre
with water ice tube
con tubo para agua
avec tube à eau à congeler

	Ø cm	↑ cm	ltr.
10770	18,0	29	3



2,5 ltr.

Saftkanne
juice pitcher
jarra de zumo
pichet à jus



mit Eiswasser-Röhre und Fruchtkammer, Inhalt mit Röhre 2,2 Liter
with water ice tube and fruit tube, capacity with tube 2,2 liters
con tubo para agua, capacidad con tubo 2,2 litros
avec tube à glaçons plongeant pour réfrigérer, capacité 2,2 litres avec le tube

	cm	↑ cm	ltr.
10768	23 x 13	27	2,5



2,0 ltr.

Saftkanne
juice pitcher
jarra de zumo
pichet à jus



	Ø cm	↑ cm	ltr.
10775	12	26	2



2,5 ltr.

Saftkanne
juice pitcher
jarra de zumo
pichet à jus de fruit



	Ø cm	↑ cm	ltr.
10776	14	29	2,5



1,5 ltr.

Pitcher
pitcher
jarra
pichet



	Ø cm	↑ cm	ltr.
93105	13	21	1,5



10771

10772

10773

10774

Karaffe / Kanne
bottle
botella
bouteille



Schraubdeckel mit aromadichtem Verschluss
screwed lid, aroma-tight
tapón de rosca, impide la fuga de aromas
bouchon à visser, ne laisse pas passer les arômes

	Ø cm	↑ cm	ltr.	Farbe / Colour
10771	11	30	1,6	
10772	11	30	1,6	
10773	11	30	1,6	
10774	11	30	1,6	



Saftdispenser „TOP FRESH“

juice dispenser
dispensador de zumo
distributeur à jus de fruit



hochglanzpoliert, Kühlung durch 2 Kühlakkus von oben und unten
mirror polished finish, cooling with 2 cooling elements from the top and base

base inox brillante, con 2 acum. de frío, 1 arriba y 1 en la base
base inox poli brillante, 2 plaques de froid (1 dans le couvercle, 1 dans le socle)

	cm	↑ cm	ltr.
10800	21 x 32	43	4
10700	23 x 35	52	6



Saftdispenser DUO „TOP FRESH“

juice dispenser
dispensador de zumo
distributeur à jus de fruit



hochglanzpoliert, Kühlung durch 2 Kühlakkus von oben und unten

mirror polished finish, cooling with 2 cooling elements from the top and base

acabado pulido brillante, 2 acum. de frío (1 en la base y 1 en la tapa)

base inox poli brillante, 2 plaques de froid (1 dans le couvercle, 1 dans le socle)

	cm	↑ cm	ltr.
10720	42 x 32	52	2 x 6



Saft- und Milchdispenser MIX „TOP FRESH“

juice and milk dispenser
dispensador mixto zumo y leche
distributeur mixte à lait et à jus de fruit



6 Liter Saftbehälter, 5 Liter Milchkanne,
Kühlung durch Kühlakkus von oben und unten

6 liters juice container, 5 liters milkcan,
cooling with cooling elements from the top and base

recipiente de zumo 6 litros, recipiente de leche 5 litros, 2 enfriadores
récipient à jus 6 l, récipient à lait 5 l, plaques de froid

	cm	↑ cm	ltr.
10760	42 x 35	52	6 + 5

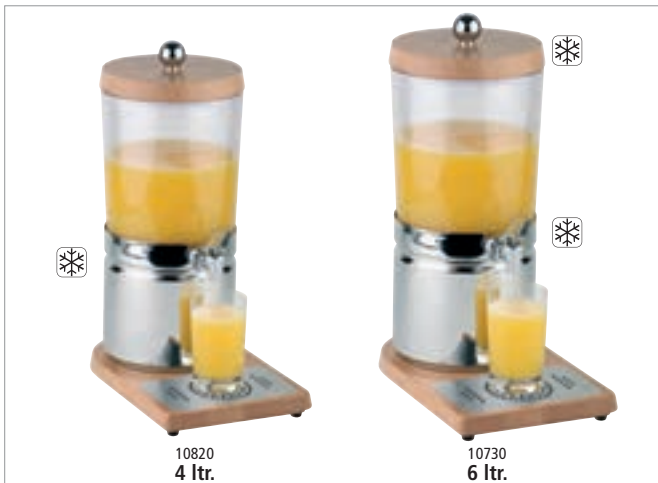

Saftdispenser WOOD „TOP FRESH“

juice dispenser
dispensador de zumo
distributeur à jus de fruit



Buchen-Holz versiegelt, Kühlung durch 2 Kühlakkus von oben und unten (nur 10730)

beech wood, waterproof, cooling with 2 cooling elements from the top and base (only 10730)

madera de haya con tratamiento anti humedad, 2 acumuladores de frío, 1 en la base y 1 en la tapa (solamente 10730)

bois de hêtre traité anti-humidité, 2 plaques de froid, 1 dans le couvercle, 1 dans le socle (seulement 10730)

	cm	↑ cm	ltr.
10820	21 x 31	44	4
10730	23 x 35	52	6



2 x 6 ltr.

Saftdispenser WOOD DUO „TOP FRESH“

juice dispenser
dispensador de zumo
distributeur à jus de fruit

HOLZ
WOOD

EDELSTAHL
STAINLESS
INOX
18/8



SAN
KUNSTSTOFF

Buchen-Holz versiegelt,

Kühlung durch 2 Kühllakkus von oben und unten

beech wood, waterproof, cooling with 2 cooling elements from the top and base

madera de haya con tratamiento anti humedad, 2 acumuladores de frío (1 en la base y 1 en la tapa)

bois de hêtre traité anti-humidité, 2 plaques de froid (1 dans le couvercle, 1 dans le socle)

	cm	↑ cm	ltr.
10740	42 x 35	52	2 x 6



6 + 5 ltr.

Saft- und Milchdispenser WOOD DUO „TOP FRESH“

juice and milk dispenser
dispensador de zumo
distributeur à jus de fruit

HOLZ
WOOD

EDELSTAHL
STAINLESS
INOX
18/8



SAN
KUNSTSTOFF

6 Liter Saftbehälter, 5 Liter Milchkanne,

Kühlung durch Kühllakkus von oben und unten, Buchen-Holz versiegelt

6 liters juice container, 5 liters milkcan, cooling with cooling elements from the top and base, beech wood, waterproof

madera de haya con tratamiento anti humedad, acumuladores de frío, enfriador en la base

bois de hêtre traité anti-humidité, plaques dans le socle

	cm	↑ cm	ltr.
10765	42 x 35	52	6 + 5



einklappbar

9,5 ltr.

Iso-Dispenser

insulated dispenser
dispensador isotérmico
distributeur de boisson isothermique

ABS
KUNSTSTOFF

EDELSTAHL
STAINLESS
INOX
18/8

für heiße und kalte Getränke

for hot and cold drinks

para bebidas frías y calientes

pour boissons chaudes ou froides

	Ø cm	↑ cm	ltr.
10788	24	42	9,5

Hahn / tap / grifo / robinet

10789



7 ltr.

Getränkespender

Drinks Dispenser
dispensador de bebidas
distributeur de boissons

GLAS
GLASS

EDELSTAHL
STAINLESS
INOX



dicke, stabile Wände, weite Öffnung für große Zutaten

thick, stable walls, a wide opening for large ingredients

tiene paredes gruesas y estables, amplia abertura para ingredientes grandes

des murs épais et stables, large ouverture pour de grands ingrédients

	Ø cm	↑ cm	ltr.
10855	20	30,5	7



Saftdispenser „SUNDAY“

juice dispenser
dispensador de zumo
distributeur à jus de fruit



matt poliert, Kühlung durch 2 Kühlakkus von oben und unten
satin polished finish, cooling with 2 cooling elements from the top and base
acabado pulido brillante, 2 acum. de frío (1 en la base y 1 en la tapa)
inox mat, 2 accus. de froid (1 socle et 1 couvercle)

	cm	↑ cm	ltr.
10860	21 x 35	48	6



Saft- / Milchdispenser „SUNDAY“

juice and milk dispenser
dispensador mixto zumo y leche
distributeur mixte à lait et à jus de fruit



matt poliert, Behälter gefrostet, Kühlung durch 2 Kühlakkus von oben und unten
satin polished finish, canister frosted look, cooling with 2 cooling elements from the top and base
inox acabado pulido mate, 1 recipiente policarbonato aspecto glaseado, 2 enfriadores en la base y en la tapa
inox mat, récipient polycarbonate opaque, 2 accus. de froid dans le socle et dans le couvercle

	cm	↑ cm	ltr.
10865	21 x 35	48	6



Saftdispenser DUO „SUNDAY“

juice dispenser
dispensador de zumo doble
distributeur à jus de fruit double



matt poliert, Kühlung durch 4 Kühlakkus von oben und unten
satin polished finish, cooling with 4 cooling elements from the top and base
inox acabado pulido mate, 4 enfriadores en la base y en la tapa
inox mat, 4 accus. de froid (socle et couvercle)

	cm	↑ cm	ltr.
10862	35 x 45	48	2 x 6



Saft- / Milchdispenser DUO „SUNDAY“

juice and milk dispenser
dispensador mixto zumo y leche
distributeur mixte à lait et à jus de fruit



matt poliert, 1 Behälter gefrostet, 1 Behälter transparent, 4 Kühlakkus von oben und unten
satin polished finish, 1 canister frosted look, 1 canister transparent, cooling with 4 cooling elements from the top and base
inox mate, 1 recipiente opaco, 1 recipiente transparente, 4 enfriadores (base y tapa)
inox mat, 1 récipient opaque, 1 récipient transparent, 4 accus. de froid (socle et couvercle)

	cm	↑ cm	ltr.
10864	35 x 45	48	2 x 6

Saftbehälter transparent, ohne Zapfhahn / juice canister transparent, without tap / contenedor transparente sin grifo / récipient cylindrique sans le robinet

	∅ cm	↑ cm	ltr.
10806	22	26	6

Milchbehälter, gefrostet, ohne Zapfhahn / milk canister, frosted look, without tap / contenedor de leche, efecto glaseado, sin grifo / récipient cylindrique mat (idéal pour le lait) sans le robinet

	∅ cm	↑ cm	ltr.
10805	22	26	6

Hahn / tap / grifo / robinet

10867



8 ltr.

Saftdispenser „INOX STAR“

juice dispenser
dispensador de zumo
distributeur à jus de fruit



Edelstahl-Crasheisröhre herausnehmbar

stainless steel crash ice tube
con tubo inox refrigerante extraíble para hielo picado
avec tube inox réfrigérant amovible pour glace pilée

	cm	↑ cm	ltr.
10795	36 x 26	55	8



2 x 8 ltr.

Saftdispenser DUO „INOX STAR“

juice dispenser
dispensador de zumo
distributeur à jus de fruit



Edelstahl-Crasheisröhre herausnehmbar

stainless steel crash ice tube
con tubo inox refrigerante extraíble para hielo picado
avec tubes inox réfrigérants amovibles pour glace pilée

	cm	↑ cm	ltr.
10810	36 x 52	55	2 x 8

Behälter / container / recipiente / récipient

	Ø cm	ltr.
10796	22	8

Deckel 18/10 Edelstahl hochglanzpoliert / cover 18/10 stainless steel mirror polished finish / tapa 18/10 inox pulido brillante / couvercle inox 18/10 poli brillant

10797

Crasheisröhre / crash ice tube / tubo para hielo picado / tube pour glace pilée

10798

Non-Drip Hahn / non-drip-tap / grifo anti-goteo / robinet anti-goutte

10799

Dichtungsring / sealing ring / arandela / rondelle

10793

Silikondichtung / sealing / junta / joint

10794

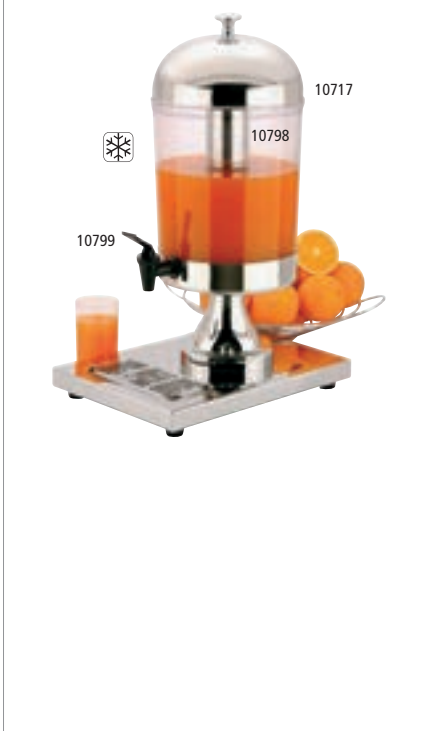

10717

10798

10799



4 ltr.

Milchkanne „TOP FRESH“

milk dispenser
dispensador de leche
distributeur à lait



inkl. Porzellanschild zum Beschriften, 1 Kühlakku im Fuß
incl. porcelain sign, 1 cooler in base
incluye cartelito en porcelana, 1 enfriador en la base
indicateur en porcelaine inclus, plaque de froid dans le socle

	cm	↑ cm	ltr.
10850	31 x 21	42	4



4 ltr.

10 ltr.

Milchkanne „TOP FRESH“

milk dispenser
dispensador de leche
distributeur à lait



Buchen-Holz versiegelt, inkl. Porzellanschild zum Beschriften, 1 Kühlakku im Fuß
beech wood, waterproof, incl. porcelain sign, 1 cooler in base
madera de haya, resistente al agua, incluye placa de porcelana, 1 enfriador en la base
socle bois hêtre traité, indicateur en porcelaine inclus, plaque de froid dans le socle

	cm	↑ cm	ltr.
10840	23 x 32	42	4
10757	27 x 38,5	45	10

Milchkanne Porzellan, ohne Zapfhahn / milkcan porcelain, without tap / jarra de leche sin grifo / récipient en porcelaine sans robinet

	Ø cm	↑ cm	ltr.
10825	18	25	4
10758	22	26	10

Deckel für 10840, 10850 / cover for 10840, 10850 / tapa para 10840, 10850 / couvercle pour 10840, 10850

10859

Deckel für 10757 / cover for 10757 / tapa para 10757 / couvercle pour 10757

10759

Schild und Kette / shield and chain / placa y cadena / indicateur porcelaine avec chaînette

10756

Zapfhahn / tap / grifo / robinet

10907



3 ltr. / 5 ltr.

Milchkanne WOOD „TOP FRESH“

milk dispenser
dispensador de leche
distributeur à lait



Buchen-Holz versiegelt, 1 Kühlakku im Standfuß, „original Milchkanne mit Henkel“
beech wood, 1 cooler in base, original milkcan
madera de haya, 1 acumulador de frio en base
bois de hêtre, 1 plaque de froid dans le socle

	cm	↑ cm	ltr.
10835	21 x 32	39	3
10755	23 x 35	47	5



3 ltr. / 5 ltr.

Milchkanne „TOP FRESH“

milk dispenser
dispensador de leche
distributeur à lait



hochglanzpoliert, 1 Kühlakku im Standfuß, „original Milchkanne mit Henkel“
mirror polished finish, 1 cooler in base, original milkcan
inox brillante, 1 acumulador de frío en la base, recipiente „lechera“
inox poli brillant, 1 accum. de froid dans le socle, design „pot à lait“

	cm	↑ cm	ltr.
10830	21 x 32	39	3
10750	23 x 35	45	5

Milchkanne ohne Zapfhahn / milkcan without tapjarra de leche sin grifo / récipient à lait sans robinet

	Ø cm	↑ cm	ltr.
10833	16	22	3
10663	22	26	5



4 ltr. / 6 ltr.

Saftdispenser „BRIDGE“

juice dispenser
dispensador de zumo
distributeur à jus



Kühlung durch 2 Kühlakkus von oben und unten
cooling with 2 cooling elements from the top and base
2 acum. de frío 1 en la base y 1 en la tapa
2 plaques de froid 1 dans le couvercle, 1 dans le socle

	cm	↑ cm	ltr.	Farbe / Colour
10870	31,0 x 20,0	42	4	■
10871	35,5 x 22,0	50	6	■

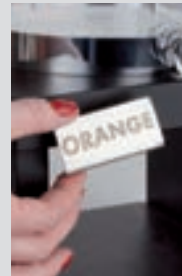

inkl. 3 Magnetschilder: ORANGE, APPLE, GRAPEFRUIT
including 3 magnetic signs: ORANGE, APPLE, GRAPEFRUIT



4 ltr. / 6 ltr.

Saftdispenser „BRIDGE“

juice dispenser
dispensador de zumo
distributeur à jus



Kühlung durch 2 Kühlakkus von oben und unten
cooling with 2 cooling elements from the top and base
2 acum. de frío 1 en la base y 1 en la tapa
2 plaques de froid 1 dans le couvercle, 1 dans le socle

	cm	↑ cm	ltr.	Farbe / Colour
10872	31,0 x 20,0	42	4	■
10873	35,5 x 22,0	50	6	■

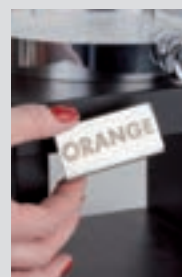

inkl. 3 Magnetschilder: ORANGE, APPLE, GRAPEFRUIT
including 3 magnetic signs: ORANGE, APPLE, GRAPEFRUIT



1) Deckel / cover / tapa / couvercle	
	für ltr. / for ltr. / para ltr. / pour ltr.
10701	6
10801	4
2) Kühlakku / cooler / acumulador de frío / accumulateur de froid	
	für ltr. / for ltr. / para ltr. / pour ltr.
10777	4 / 6
3) Behälter inkl. Zapfhahn / container inc. tap recipiente con grifo / récipient avec robinet	
	für ltr. / for ltr. / para ltr. / pour ltr.
10703	6
10803	4
3) Behälter ohne Zapfhahn / container without tap recipiente sin grifo / récipient sans robinet	
	für ltr. / for ltr. / para ltr. / pour ltr.
10704	6
10804	4
4) Non-Drip Hahn / non-drip tap / grifo anti-goteo / robinet anti-goutte	
	für ltr. / for ltr. / para ltr. / pour ltr.
10707	6
10807	4
5) Dichtungsring / sealing ring / arandela / rondelle	
	für ltr. / for ltr. / para ltr. / pour ltr.
10608	4 / 6
6) Einsatz / insert / aro inox / cercle inox	
	für ltr. / for ltr. / para ltr. / pour ltr.
10708	6
10808	4
7) Standfuß 18/10 Edelstahl / column 18/10 stainless steel base inox 18/10 / socle inox 18/10	
	für ltr. / for ltr. / para ltr. / pour ltr.
10709	6
10809	4
8) Tropfgitter 18/10 Edelstahl / drip lattice 18/10 stainless steel rejilla recoge gotas 18/10 / grille ramasse-gouttes 18/10	
	für ltr. / for ltr. / para ltr. / pour ltr.
10712	6
10713	DUO
10812	4
9) Bodenplatte 18/10 Edelstahl / footing 18/10 stainless steel base de 18/10 acero / socle inox 18/10	
	für ltr. / for ltr. / para ltr. / pour ltr.
10710	6
10711	DUO / 6 + 6
10814	4
Zubehör / Reinigungsset - für die regelmäßige Reinigung	
1x Dichtung, 2x Dichtungsring (transparent), 1x Dichtungsring (s / w) 1x seal, 2x sealing ring (transparent), 1x sealing ring (b / w)	
10714	für Zapfhahn 10707
10715	für Zapfhahn 10807
10716	für Zapfhahn 10907
10717	für Zapfhahn 10867



Getränkespender

Drinks Dispenser
dispensador de bebidas
distributeur de boissons



dicke, stabile Wände, weite Öffnung für große Zutaten
thick, stable walls, a wide opening for large ingredients
tiene paredes gruesas y estables, amplia abertura para ingredientes grandes
des murs épais et stables, large ouverture pour de grands ingrédients

	Ø cm	↑ cm	ltr.
10855	20	30,5	7



Tropfenschale (2-tlg.)

drip tray
aros anti-goteo
anneaux coupe-gouttes



	Ø cm	↑ cm	Farbe / Colour
10851	9,5	1,5	White
10853	9,5	1,5	Black

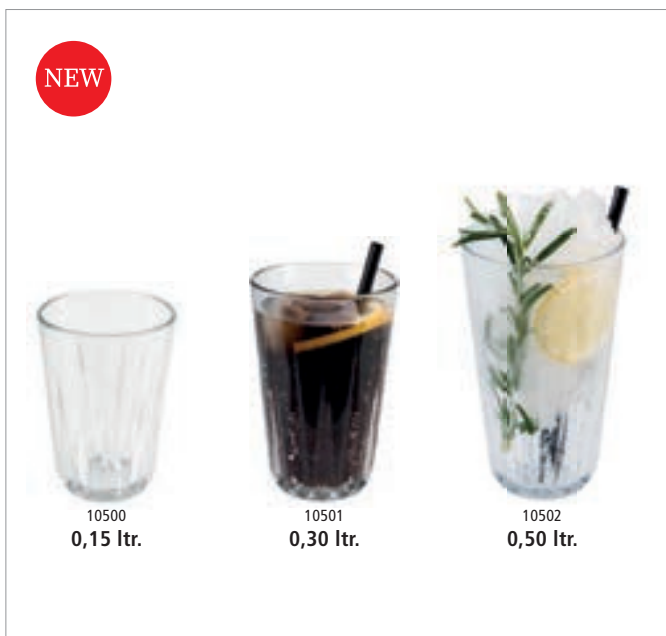

Trinkbecher „CRYSTAL“

drinking cups
vasos
gobelets



Kristallglas-Optik, vielseitig einsetzbar, robustes, unzerbrechliches Material, ideal in sensiblen Bereichen wie Pool, Spa, Beach und Wellness einzusetzen, BPA-frei
crystal-glass-look, can be used in versatile ways, a solide and unbreakable material, ideal to be used in pool, spa, beach and wellness areas, bpa-free
look de vidrio, se pueden utilizar de muchas maneras diferentes, material sólido e irrompible, ideal para el uso en áreas como piscina, spa, playa y bienestar, libre de BPA
look de verre de cristal, peuvent être utilisés de différentes façons, matériau robuste et incassable, idéal pour une utilisation dans des zones comme la piscine, le spa, la plage et le bien-être, sans BPA

	Ø cm	↑ cm	ltr.	VE
10500	7	9,5	0,15	48
10501	8	12,5	0,30	48
10502	9	15,5	0,50	48

Buffetständer



Buffetständer „STAR“

buffet stand
soporte para bufé
présentoir buffet



Metall, mit schwarzer Antirutschgummierung
metal, with black anti-slide coating
acero cromado, con recubrimiento negro antideslizante
metal avec revêtement plastique noir antiglisse

	↑ cm
33260	8
33261	12
33262	18



Buffetständer „MULTI ROUND“

buffet stand
soporte para bufé
présentoir buffet



Metall, mit schwarzer Antirutschgummierung
metal, with black anti-slide coating
acero, con recubrimiento negro antideslizante
metal, revêtement plastique noir anti-glisse

	Ø cm	↑ cm
33269	15,5 / 18	8
33270	15,5 / 18	10
33271	15,5 / 18	18

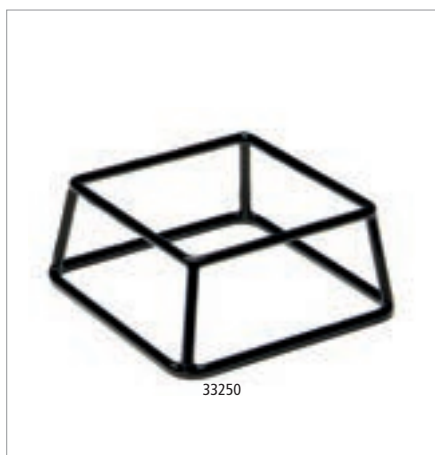

Buffetständer „MULTI“

buffet stand
soporte para bufé
présentoir buffet



Metall, mit schwarzer Antirutschgummierung ummantelt
metal, with black anti-slide coating
acero cromado, con recubrimiento negro antideslizante
metal avec revêtement plastique noir antiglisse

	cm	↑ cm
33249 NEW	18 x 18	5
33250	18 x 18	8
33251	18 x 18	10
33252	18 x 18	18

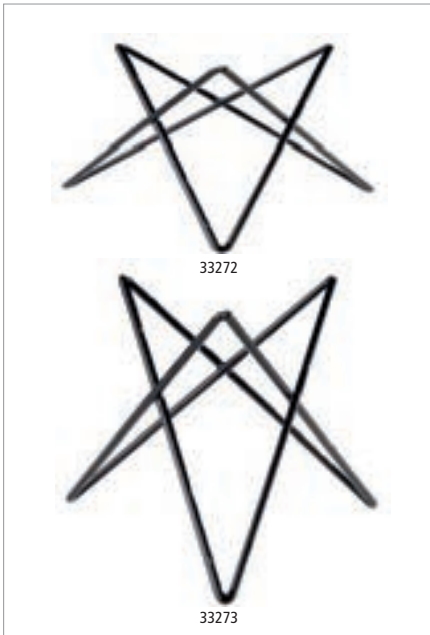

Buffetständer „PRISMA“

buffet stand
soporte para bufé
présentoir buffet



Metall, mit schwarzer Antirutschgummierung
metal, with black anti-slide coating
acero, con recubrimiento negro antideslizante
metal, revêtement plastique noir antiglisse

	Ø cm	↑ cm
33272	20	10,5
33273	20	20



Buffetständer „DIAMOND“

buffet stand
soporte para bufé
présentoire buffet



Metall, mit Antirutschgummierung
metal, with anti-sliding coating
acero, con recubrimiento antideslizante
metal, revêtement plastique antiglisse

	Ø cm	↑ cm	Farbe / Colour
33274	20 /25	10	
33275	20 /25	19,5	
33276	20 /25	10	
33277	20 /25	19,5	



Buffetständer „WOOD“

buffet stand
soporte para bufé
présentoire buffet



Akazienholz, liegend oder stehend, variable Nutzungsmöglichkeiten
acacia wood, usable by lying or standing, there are variable usage possibilities
madera de acacia, se puede usar tumbado o de pie, hay diferentes opciones de utilizar
bois d'acacia, il y a différentes possibilités d'usage

	cm	↑ cm	Farbe / Colour
33280	20 x 20	17,5	
33281	20 x 20	17,5	



liegend oder stehend, variable Nutzungsmöglichkeiten
vertically or horizontally, there are variable usage possibilities



Buffetständer
buffet stand
expositor de bufé
présentoir buffet



Akazienholz
acacia wood
madera de acacia
bois d'accacia

	Ø cm	↑ cm
33255	15	10
33256	25	15



Buffetständer „ASIA PLUS“
buffet stand
soporte para bufé
présentoir buffet



	Ø cm	↑ cm	Farbe / Colour
15515	38,0	16,5	■
15516	38,0	27,0	■
15517	48,5	16,5	■
15518	48,5	27,0	■



Buffetständer „ASIA PLUS“
buffet stand
soporte para bufé
présentoir buffet



	Ø cm	↑ cm	Farbe / Colour
15519	38,0	16,5	■
15520	38,0	27,0	■
15521	48,5	16,5	■
15522	48,5	27,0	■

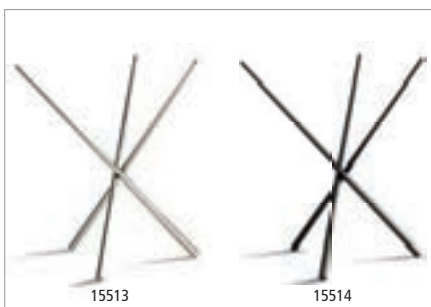

Buffetständer „ASIA PLUS“
buffet stand
soporte para bufé
présentoir buffet



	Ø cm	↑ cm	Farbe / Colour
15513	20,5 / 16,5	20	■
15514	20,5 / 16,5	20	■



Buffetständer „KING“
buffet stand
soporte para bufé
présentoir buffet



kein Verrutschen, Arme und Boden sind mit Antirutschflächen ausgestattet, schwere stand-sichere Qualität, Fuß dient als Löffelablage
the arms and base are equipped with non-slip surfaces, stable quality, base serves as spoon holder
anti-deslizante: revestimiento antideslizante en las puntas de los brazos y en la base, estable y alta calidad, la base sirve como reposacuchara
antiglisse: revêtement antidérapant sur les extrémités des 3 pieds et sur la base, robuste, stable et bonne qualité, la base sert de support pour les couverts

	Ø cm	↑ cm
03622	15	14
03623	15	21



30 x 15 cm

40 x 17,5 cm

53 x 19 cm

Buffetgestell „TRIANGLE“

buffet stand
expositor de bufé
présentoir à céréales



	cm	↑ cm	Farbe / Colour
13966	53 x 21	50	Ahorn / maple



30 x 15 cm

40 x 17,5 cm

53 x 19 cm

Buffetgestell „TRIANGLE“

buffet stand
expositor de bufé
présentoir à céréales



	cm	↑ cm	Farbe / Colour
14966	53 x 21	50	Wenge / wenge



Buffet-Tower

Buffet-Tower
torre para bufé
tour carrée pour le buffet



3-stufig, Glas in Spiegeloptik, Holz Birke dunkelbraun, Lieferung demontiert
with beech wood pillar, tempered glass mirror surface, each in knock-down packing
3 pisos, vidrio templado, eje central de madera oscura, se entrega desmontado
3 étages, verre trempé, axe central carré en bois foncé, livré non-monté

	cm	↑ cm
12415	25 x 25	30,5



High Tea Rack

High Tea Rack
rack de te alto
étagère à thé avec anse supérieure



Holz dunkelbraun, Edelstahlgriff, 4 große Fächer 15 x 10 x 10 cm,
3 kleine Fächer 9,5 x 9,5 x 10 cm
rubber wood in dark brown, stainless handle, 4 big compartments 15 x 10 x 10 cm, 3 small compartments 9,5 x 9,5 x 10 cm
madera marrón oscura, mango de acero inoxidable, 4 compartimentos grandes 15 x 10 x 10 cm, 3 compartimentos pequeños 9,5 x 9,5 x 10 cm
bois marron foncé, poignée inox, 4 compartiment grand 15 x 10 x 10 cm, 3 compartiment petit 9,5 x 9,5 x 10 cm

	cm	↑ cm
33210	34 x 10	38

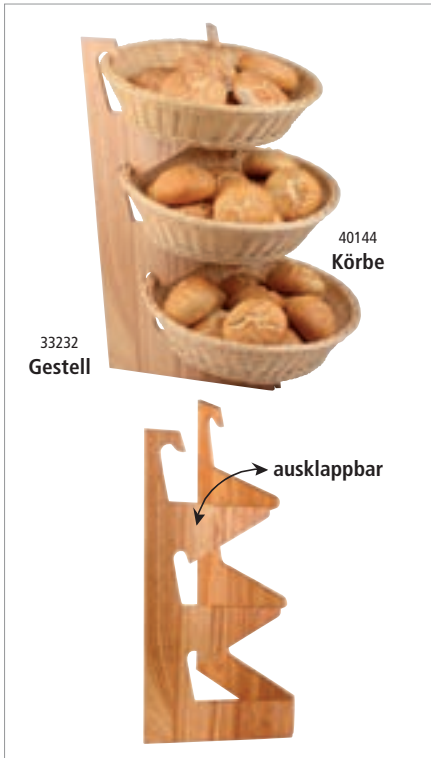

Buffetgestell

buffet stand
soporte para bufé
présentoir buffet



3-stufig, geeignet für runde und rechteckige Körbe, platzsparend zusammenklappbar, Lieferung ohne Körbe

3-tier, usable for round and rectangular baskets, can be pushed together for place saving, delivery without baskets

3 alturas, apto para cestas redondas y rectangulares, se puede plegar para ahorrar espacio, se entrega sin cestas

3 hauteurs, pour corbeilles rondes ou rectang, la structure s'ouvre ou se ferme pour réduire l'encombrement, livré sans corbeilles

	cm	↑ cm
33232	59 x 30,5	59

Tisch- und Buffetkorb, rund „ECONOMIC“ / buffet basket, round / cesta de bufé redonda / corbeille de buffet ronde

	Ø cm	↑ cm	Farbe / Colour
40144	39,0	10,0	

Korb „GN LINE“ / GN basket / GN cesta / GN corbeille

	cm	↑ cm	Farbe / Colour
40240	53 x 32,5	10	
40270	53 x 32,5	10	

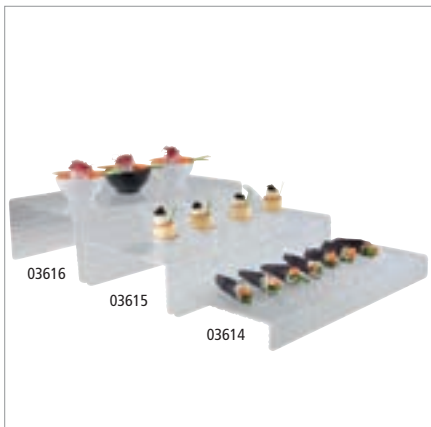

Stufen-Display

tier display
expositor en escalera
présentoir en escalier



mit Schieferstruktur
with slate structure
con relieve tipo pizarra
avec relief irrégulier type ardoise

	cm	↑ cm
03614	40 x 18	4
03615	40 x 20	8
03616	40 x 22	12



Stufen-Display, 3-tlg.

tier display, 3 pcs.
expositor en escalera, 3 piez.
présentoir en escalier, 3 pcs.



3-teiliges Set: 03614 + 03615 + 03616
3 pcs. set: 03614 + 03615 + 03616
set de 3 piezas: 03614 + 03615 + 03616
set 3 pièces: 03614 + 03615 + 03616

	cm	↑ cm
03617	40 x 18 / 40 x 20 / 40 x 22	4 / 8 / 12



Stufen-Display, 3-tlg.

tier display, 3 pcs.
expositor en escalera, 3 piez.
présentoir en escalier, 3 pcs.



3-teiliges Set: 03618 + 03619 + 03620
3 pcs. set: 03618 + 03619 + 03620
set de 3 piezas: 03618 + 03619 + 03620
set 3 pièces: 03618 + 03619 + 03620

	cm	↑ cm
03621	20 x 18 / 20 x 20 / 20 x 22	4 / 8 / 12

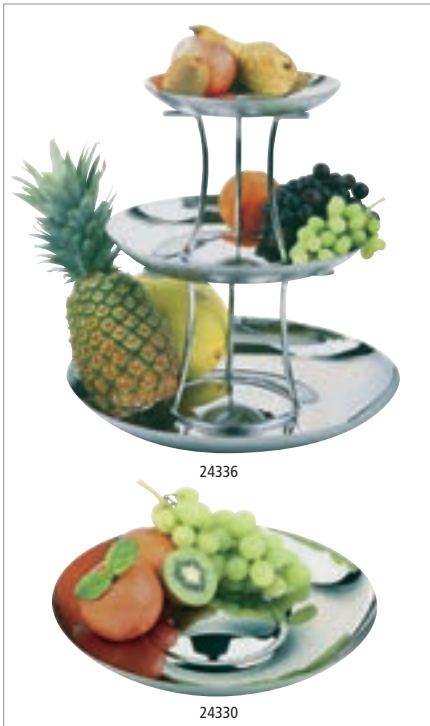

Etagère „ROYAL“

etagère
expositor
présentoir



5-teilig: 3 Edelstahl-Schalen + 2 Gestelle, einfach übereinanderstellen, einzeln nutzbar

5 pcs. set: 3 bowls + 2 frames, easy to assemble, single usable

set de 5 piezas: 3 bols + 2 soportes, fácil de montar

5 éléments: 3 bols + 2 supports, montage facile

	Ø cm	↑ cm
24336	24 / 33 / 42	43,5

Schale / bowl / fuente / plateau

	Ø cm	↑ cm	litr.
24330	24	3	0,6
24331	33	4	1,3
24332	42	5	2,5

Gestell einzeln / stand alone / pie soporte / pied seul

	Ø cm	↑ cm
24338	18	19
24339	24	20

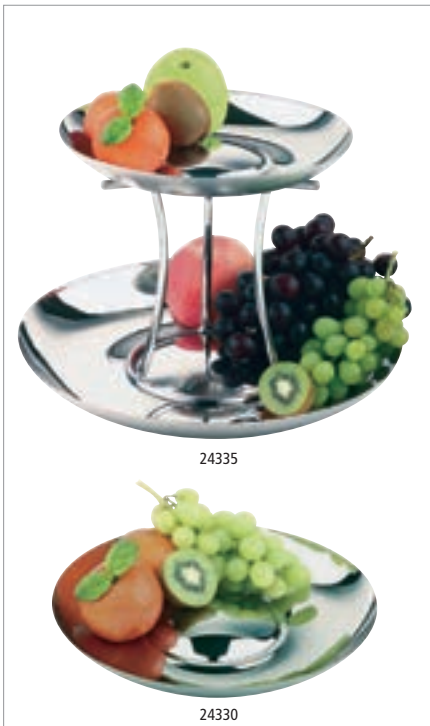

Etagère „ROYAL“

etagère
estante
présentoir



3-teilig: 2 Edelstahl-Schalen + 1 Gestell, einfach übereinanderstellen, einzeln nutzbar

3 pcs. set: 2 bowls + 1 frame, easy to assemble, single usable

set de 3 piezas: 2 bols + 1 soporte, fácil de montar

3 éléments: 2 bols + 1 support, montage facile

	Ø cm	↑ cm
24335	33 / 42	25
24334	24 / 33	22

Schale / bowl / fuente / plateau

	Ø cm	↑ cm	litr.
24330	24	3	0,6
24331	33	4	1,3
24332	42	5	2,5

Gestell einzeln / stand alone / pie soporte / pied seul

	Ø cm	↑ cm
24338	18	19
24339	24	20



Etagère

etagère
frutero
corbeille à fruits



ergonomischer Griff, stehend auf schwarzen Antirutsch-Füßen

ergonomic handle, anti-slip-feet

asa ergonómica, pies antideslizantes color negro

anse ergonomique, pieds antidérapants noirs

	cm	↑ cm
30325	30 x 30	35,5

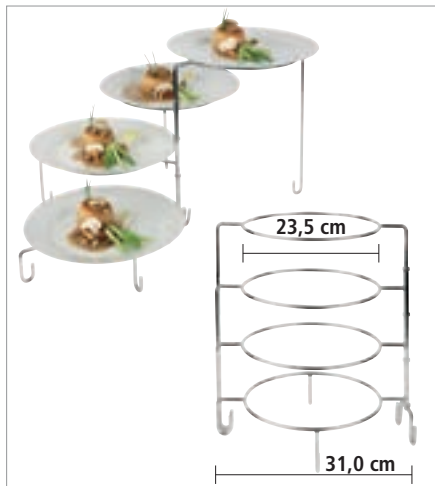

Serviergestell

serving stand
soporte platos
présentoir à assiettes



für 4 Teller (max. Ø 31 cm), platzsparend zusammendrehbar, Lieferung ohne Teller
for 4 plates (max. Ø 31 cm), can be pushed together for place saving, without dishes
para 4 platos (max. Ø 31 cm) se puede plegar para ahorrar espacio, se sirve sin platos
pour 4 assiettes (maxi Ø 31 cm), peut se refermer pour réduire l'encombrement, livré sans assiettes

	Ø cm	↑ cm
33225	34	37

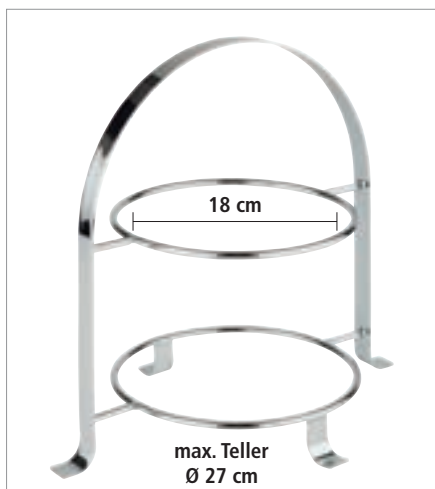

Serviergestell

serving stand
soporte platos
présentoir à assiettes



für 2 Teller max. Ø 27 cm, innerer Ring Ø 18 cm, Lieferung ohne Teller
for 2 plates max. Ø 27 cm, circle inside Ø 18 cm, without dishes
para 2 platos Ø 27 cm, interior aro Ø 18 cm, se entrega sin platos
pour 2 assiettes maxi Ø 27 cm, cercle Ø int. 18 cm, livré sans assiettes

	cm	↑ cm
33214	33 x 23,5	30



Serviergestell

serving stand
soporte platos
présentoir à assiettes



für 3 Teller max. Ø 17 cm, innerer Ring Ø 10,5 cm
for 3 plates max. Ø 17 cm, circle inside Ø 10,5 cm
para 3 platos Ø 17 cm, interior aro Ø 10,5 cm
pour 3 assiettes maxi Ø 17 cm, cercle Ø int. 10,5 cm

	cm	↑ cm
33216	22,5 x 16,5	25,5



Serviergestell

serving stand
soporte platos
présentoir à assiettes



für 3 Teller max. Ø 27 cm, innerer Ring Ø 18 cm
for 3 plates max. Ø 27 cm, circle inside Ø 18 cm
para 3 platos Ø 27 cm, interior aro Ø 18 cm
pour 3 assiettes maxi Ø 27 cm, cercle Ø int. 18 cm

	cm	↑ cm
33217	33 x 24	43

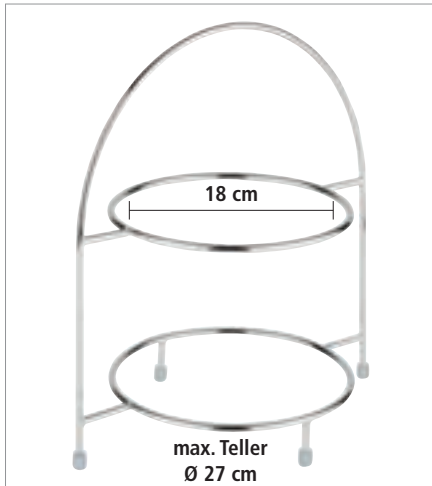

Serviergestell
serving stand
soporte platos
présentoir à assiettes



für 2 Teller max. Ø 27 cm, innerer Ring Ø 18 cm
for 2 plates max. Ø 27 cm, circle inside Ø 18 cm
para 2 platos Ø 27 cm, interior aro Ø 18 cm
pour 2 assiettes maxi Ø 27 cm, cercle Ø int. 18 cm

	cm	↑ cm	Farbe / Colour
33219	29 x 19,5	30	



Serviergestell
serving stand
soporte platos
présentoir à assiettes



für 3 Teller max. Ø 17 cm, innerer Ring Ø 10,5 cm
for 3 plates max. Ø 17 cm, circle inside Ø 10,5 cm
para 3 platos Ø 17 cm, interior aro Ø 10,5 cm
pour 3 assiettes maxi Ø 17 cm, cercle Ø int. 10,5 cm

	cm	↑ cm	Farbe / Colour
33215	18,5 x 15,5	26	chrome
33211	18,5 x 15,5	26	copper



Serviergestell
serving stand
soporte platos
présentoir à assiettes



für 3 Teller max. Ø 27 cm, innerer Ring Ø 18 cm
for 3 plates max. Ø 27 cm, circle inside Ø 18 cm
para 3 platos Ø 27 cm, interior aro Ø 18 cm
pour 3 assiettes maxi Ø 27 cm, cercle Ø int. 18 cm

	cm	↑ cm	Farbe / Colour
33220	29 x 19,5	43	chrome
33212	29 x 19,5	43	copper



Etagère
etagère
frutero
présentoir à fruits



hochglanzpoliert, Edelstahl-Schale herausnehmbar
mirror polished finish, bowl removable
acabado brillante, bandeja inferior suelta
effet brillant, bol inférieure amovible

	Ø cm	↑ cm
33235	27,5	32
33240	32	53



Serviergestell

serving stand
expositor
présentoir



3-stufig für quadratische Teller / Platten in 3 verschiedenen Größen: z.B. 83407 + 83406 + 83405, Lieferung ohne Teller/Platten

3-tier for square dishes / plates in 3 different sizes: e.g. 83407 + 83406 + 83405, delivery without dishes / plates

3 alturas para platos cuadrados fuentes en 3 diferentes medidas p.e. 83407 + 83406 + 83405, se entrega sin platos/ fuentes

3 niveaux pour assiettes ou plats carrés de différentes dimensions, ex. 83407 + 83406 + 83405, livré sans assiettes

	cm	↑ cm
33231	37,5 x 37,5	50



Etagère „CASUAL“

etagère
expositor de bombones o bocaditos
présentoir à mignardises



inklusive Edelstahl-Schild, beschriftbar

including sign

placa incluida, sin inscripción

étiquette incluse, sans inscription

	Ø cm	↑ cm	
34248	31 - 41 - 51	55	3-stufig / 3-tier 3 niveles / 3 étages
34247	31 - 41	35	2-stufig / 2-tier 2 niveles / 2 étages



Etagère „FINESSE“

etagère
frutero
étagère



vergoldeter Messing-Kugelgriff, einfache Montage

gold plated knob, easy to assemble

botón dorado, fácil de montar

bouton doré, montage facile

	Ø cm	↑ cm	
33248	48 / 38 / 32	50	3-stufig / 3-tier 3 alturas / 3 niveaux
33238	38 / 32	30	2-stufig / 2-tier 2 alturas / 2 niveaux



3-stufige Etagère

3-tier tray
bandeja con tres alturas
étagère carré 3 hauteurs



Naturschiefer, Akazienholz

natural slate tray, wood akazie

bandeja de pizarra natural, madera

plateau ardoise naturelle, bois

	Ø cm	↑ cm	* mm
00960	30 / 25 / 20	34	6 - 9



2-stufige Etagère
2 tier tray
bandeja dos alturas
plat carré 2 hauteurs



Naturschiefer
natural slate tray
bandeja de pizarra natural
plateau ardoise naturelle

	Ø cm	↑ cm	* mm
00989	25 / 20	24	6 - 9



Etagère
etagère
expositor
présentoir à petits fours



	Ø cm	↑ cm
00193	14 / 11	16



Brezel- oder Wurstständer
pretzel-/ sausage stand
soporte para embutidos
support à bretzel ou à saucissons



matt poliert
satin polished finish
acabado pulido satinado
poli satiné

	Ø cm	↑ cm
79554	21	50

Hygieneschutz für Brezelständer / hygienic cover / cubierta higiénica antialiento / pare-haleine

	cm	↑ cm
11558	15 x 20 x 15	50



Brezel- oder Wurstständer
pretzel-/ sausage stand
soporte para embutidos
support à bretzel ou à saucissons



Verkaufsständer Buchen-Holz versiegelt, bestens geeignet für die Präsentation von Brezeln, Würstchen, etc., Fuß Ø 22 cm
beech wood, ideal to present pretzels, sausages, etc.
madera de haya, ideal para presentar fiambres, salchichones etc.
en hêtre, idéal pour bretzels ou saucissons, etc.

	Ø cm	↑ cm
79553	28	50

Hygieneschutz für Brezelständer / hygienic cover / cubierta higiénica antialiento / pare-haleine

	cm	↑ cm
11557	20 x 20 x 20	50



Serviergestell „FLEXIBEL“

serving stand
expositor
présentoir

3-stufig „beweglich / drehbar“, platzsparend zerlegbar
3 tier, flexible frame, space saving
3 alturas, marco flexible, ahorra espacio
3 hauteurs, cadre souple, gagne de la place



	cm	↑ cm
33243	45,5 x 32	21,5

Tablett „PURE COLOR“ / tray / bandeja / plateau

	cm	↑ cm	Farbe / Colour
83403	35,5 x 18,0	3	

	cm	↑ cm	Farbe / Colour
83566	35,5 x 18,0	3	
83567	35,5 x 18,0	3	



Tablett „PURE“

tray
bandeja
plateau



Edelstahl matt poliert, passend für Melamin-Schalen
stainless steel satin polished finish, for melamin bowls
acero inoxidable mate, apta para cuencos de melamina
inox mat, concient pour bols mélamine

	cm	
30120	20 x 11	für 2 Schalen / for 2 bowls para 2 cuencos / pour 2 bols
30122	20 x 20	für 4 Schalen / for 4 bowls para 4 cuencos / pour 4 bols
30121	29 x 20	für 6 Schalen / for 6 bowls para 6 cuencos / pour 6 bols



Schale „PURE COLOR“

bowl
cuenco
bol



	cm	↑ cm	Farbe / Colour
83414	9,0 x 9,0	4,0	
83466	9,0 x 9,0	4,0	
83568	9,0 x 9,0	4,0	
83569	9,0 x 9,0	4,0	



Serviergestell „S-PURE“

serving stand
soporte bufé
support buffet



für 3 Tablett quadratisch 83407 oder 83418
for 3 trays square 83407 or 83418
para 3 bandejas cuadradas 83407 o 83418
pour 3 plats carrés 83407 ou 83418

	cm	↑ cm
33226	29 x 17	41



Serviergestell „M-PURE“

serving stand
soporte bufé
support buffet



für 3 Tablett quadratisch 83406 oder 83407
for 3 trays square 83406 or 83407
para 3 bandejas cuadradas 83406 o 83407
pour 3 plats carrés 83406 o 83407

	cm	↑ cm
33227	33 x 21	44



Serviergestell „L-PURE“

serving stand
soporte bufé
support buffet



für 3 Tablett rechteckig 83417
for 3 trays rectangular 83417
para 3 bandejas rectangulares 83417
pour 3 plats rectangulaires 83417

	cm	↑ cm
33228	37 x 21	44



GN Serviergestell „XL-PURE“

GN serving stand
GN soporte bufé
GN support buffet



passend für Tablett GN 1/1, GN 1/2, GN 1/3, GN 2/4
suitable for tray GN 1/1, GN 1/2, GN 1/3, GN 2/4
aptas para bandejas GN 1/1, GN 1/2, GN 1/3, GN 2/4
convient pour les plats GN 1/1, GN 1/2, GN 1/3, GN 2/4

	cm	↑ cm
33222	63 x 27	44,5



Buffetgestell „FLOAT SMALL“

buffet stand
soporte bufé
support buffet



Metall verchromt, für 3 Schalen Nr. 83916, 83917
metal chrome plated, for 3 bowls no. 83916, 83917
metal cromado, para 3 cuencos N° 83916, 83917
métal chromé, pour 3 coupelles 83916, 83917

	cm	↑ cm
33241	55,5 x 19	15,5

Schale „FLOAT“ / bowl / cuenco / bol

	cm	↑ cm	Farbe / Colour
83916	19 x 19	9,5	White
83917	19 x 19	9,5	Black



Buffetgestell „FLOAT BIG“

buffet stand
soporte bufé
support buffet



Metall verchromt, für 3 Schalen Nr. 83914, 83915, für 1 Schale Nr. 83918, 83919
metal chrome plated, for 3 bowls no. 83914, 83915, for 1 bowl no. 83918, 83919
metal cromado, para 3 cuencos N° 83914, 83915, para 1 cuenco N° 83918, 83919
métal chromé, pour 3 coupelles 83914, 83915 ou 1 bol 83918, 83919

	cm	↑ cm
33242	39 x 39	17

Schale „FLOAT“ / bowl / cuenco / bol

	cm	↑ cm	Farbe / Colour
83914	12,5 x 12,5	6,0	White
83918	25 x 25	12,0	White
83915	12,5 x 12,5	6,0	Black
83919	25 x 25	12,0	Black



NEW

Buffetgestell, 3-tlg.

buffet stand, 3 pcs.
expositor de bufé, set de 3 piezas
présentoir a céréales, set de 3 éléments



3-teilig: 1. Fach 40 x 20 cm x H 33 cm; 2. Fach 40 x 17 cm x H 21 cm; 3. Fach 40 x 14,5 cm x H 9 cm
3 pcs. set: 40 x 20 cm x H 33 cm; 40 x 17 cm x H 21 cm; 40 x 14,5 cm x H 9 cm
set de 3 piezas: 40 x 20 cm x H 33 cm; 40 x 17 cm x H 21 cm; 40 x 14,5 cm x H 9 cm
3 éléments: 40 x 20 cm x H 33 cm; 40 x 17 cm x H 21 cm; 40 x 14,5 cm x H 9 cm

	cm	↑ cm	Farbe / Colour	
11606	40 x 20	33	■	Wenge



NEW

Buffetgestell, 3-tlg.

buffet stand, 3 pcs.
expositor de bufé, set de 3 piezas
présentoir a céréales, set de 3 éléments



3-teilig: 1. Fach 40 x 40 cm x H 33 cm; 2. Fach 40 x 37 cm x H 21 cm; 3. Fach 40 x 34 cm x H 9 cm
3 pcs. set: 40 x 40 cm x H 33 cm; 40 x 37 cm x H 21 cm; 40 x 34 cm x H 9 cm
set de 3 piezas: 40 x 40 cm x H 33 cm; 40 x 37 cm x H 21 cm; 40 x 34 cm x H 9 cm
3 éléments: 40 x 40 cm x H 33 cm; 40 x 37 cm x H 21 cm; 40 x 34 cm x H 9 cm

	cm	↑ cm	Farbe / Colour	
11607	40 x 40	33	■	Wenge



NEW

Serviergestell, 2-stufig

serving stand, 2-tier
soporte platos, 2 alturas
présentoir, 2 hauteurs



3 tlg. Set, 1 Gestell aus Akazienholz, 2 Schieferplatten, zusammenklappbar
3 pcs. set, 1 stand acacia wood, 2 slate tray, foldable
set de 3 piezas, 1 soporte madera de acacia, 2 bandeja de pizarra, fácil de plegar
set de 3 pièces, 1 présentoir au pour tous les seaux à FRAMES

	cm	↑ cm	
00958	34	36,5 x 26,5	



zusammenklappbar
foldable

Buffetleiter GN



Buffetleiter „LITTLE GN 1/3“

buffet ladder
dispensador en escalera
présentoir buffet en escalier



4-teilig: 1 Leiter-Gestell, 3 GN 1/3 Rahmen
4 pcs.: 1 ladder, 3 single rings GN 1/3
4 pz: 1 soporte escalera, 3 aros sencillos GN 1/3
4 pc: 1 support escalier, 3 cercles simples GN 1/3

	cm	↑ cm	fits to
11526	31,5 x 32	48	baskets / pans GN 1/3



Buffetleiter „LITTLE GN 1/2“

buffet ladder
dispensador en escalera
présentoir buffet en escalier



4-teilig: 1 Leiter-Gestell, 3 GN 1/2 Rahmen
4 pcs.: 1 ladder, 3 single rings GN 1/2
4 pz: 1 soporte escalera, 3 aros sencillos GN 1/2
4 pc: 1 support escalier, 3 cercles simples GN 1/2

	cm	↑ cm	fits to
11527	31,5 x 41,5	48	baskets / pans GN 1/2

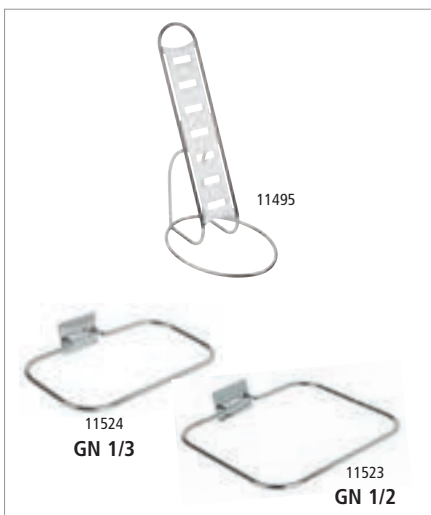

Einzelteile / spare parts / piezas sueltas / pièces détachées

Leitergestell / frame / marco solo en escalera / échelle support

11495

Einzelring GN 1/3 / single ring GN 1/3 / aro sencillo GN 1/3 / cercle simple GN 1/3

11524

Einzelring GN 1/2 / single ring GN 1/2 / aro sencillo GN 1/2 / cercle simple GN 1/2

11523



4 x GN 1/2

Buffetleiter „BIG GN 1/2“
buffet ladder
dispensador en escalera
présentoir buffet en escalier



5-teilig: 1 Leiter-Gestell, 4 GN 1/2 Rahmen
5 pcs.: 1 ladder, 4 single rings GN 1/2
5 pz: 1 soporte escalera, 4 aros sencillos GN 1/2
5 pc: 1 support escalier, 4 cercles simples GN 1/2

	cm	↑ cm	fits to
11528	31,5 x 56	66	baskets / pans GN 1/2



3 x GN 1/1

Buffetleiter „BIG GN 1/1“
buffet ladder
dispensador en escalera
présentoir buffet en escalier



4-teilig: 1 Leiter-Gestell, 3 GN 1/1 Rahmen
4 pcs.: 1 ladder, 3 single rings GN 1/1
4 pz: 1 soporte escalera, 3 aros sencillos GN 1/1
4 pc: 1 support escalier, 3 cercles simples GN 1/1

	cm	↑ cm	fits to
11529	52 x 59	66	baskets / pans GN 1/1

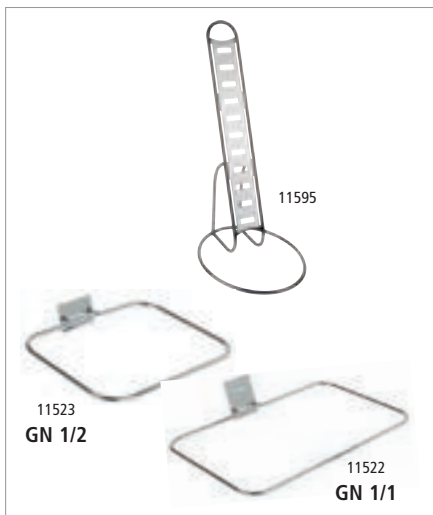

Einzelteile / spare parts / piezas sueltas / pièces détachées

Leitergestell / frame / marco solo en escalera / échelle support

11595

Einzelring GN 1/2 / single ring GN 1/2 / aro sencillo GN 1/2 / cercle simple GN 1/2

11523

Einzelring GN 1/1 / single ring GN 1/1 / aro sencillo GN 1/1 / cercle simple GN 1/1

11522



Buffetleiter „BIG“

buffet ladder
dispensador en escalera
présentoir buffet en escalier



12-teiliges Set: 4 Glasschalen Ø 23 cm 2,5 Liter, 4 klappbare Schutzdeckel mit Beschriftungsfenster, 1 Leiter, 1 Doppelring, 2 Einzelringe, einfach und individuell zusammensetzbar
12 pcs. set: 4 glass bowls Ø 23 cm 2.5 litres, 4 hinged covers with card for inscription, 1 ladder, 1 double ring, 2 single rings, easy to fix and individual to use
set 12 pz: 4 boles vidrio Ø 23 cm 2,5 l, 4 tapas abatibles con ventana para etiqueta, 1 soporte escalera, 1 aro doble, 2 aros sencillos, fácil de montar, posible usar individualmente
12 éléments: 4 bols verre Ø 23 cm 2,5 l, 4 couvercles à charnière et fenêtre p/ étiquette, 1 support escalier, 1 cercle double, 2 cercles simples, montage facile, utilisable individuellement

	cm	↑ cm
11598	39 x 31	66



Buffetleiter „BIG“

buffet ladder
dispensador en escalera
Présentoir buffet en escalier



11-teiliges Set: 6 Glasschalen Ø 23 cm 2,5 Liter, 1 Leiter, 2 Doppelringe, 2 Einzelringe, einfach und individuell zusammensetzbar
11 pcs. set: 6 glass bowls Ø 23 cm 2.5 litres, 1 ladder, 2 double rings, 2 single rings, easy and individual to use
set 11 pz: 6 boles vidrio Ø 23 cm 2,5 l, 1 soporte escalera, 2 aros dobles, 2 aros sencillos, fácil montar, se puede usar individualmente
11 éléments: 6 bols verre Ø 23 cm 2,5 l, 1 support escalier, 2 cercles double, 2 cercles simples, montage facile, utilisable individuellement

	cm	↑ cm
11599	39 x 31	66

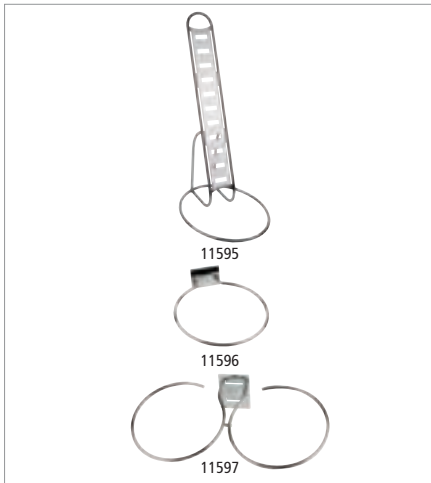

Einzelteile / spare parts / piezas sueltas / pièces détachées

Leitergestell / frame / marco solo en escalera / échelle support

11595

Einzelring / single ring / aro sencillo / cercle simple

11596

Doppelring / double ring / aro doble / cercle double

11597



Schale

bowl
cuenco
bol



	Ø cm	↑ cm	ltr.
11875	23	10,5	2,5



Schutzdeckel mit Löffelaussparung

cover
tapa
couvercle



	Ø cm
11878	23,5



jede Schale /
each bowl
ca. 0,5 ltr.

Buffetleiter „LITTLE“

buffet ladder
dispensador en escalera
présentoir buffet en escalier



12-teiliges Set: 4 Glasschalen Ø 14 cm 0,5 Liter, 4 klappbare Schutzdeckel mit Beschriftungsfenster, 1 Leiter, 1 Doppelring, 2 Einzelringe, einfach und individuell zusammensetzbar
12 pcs. set: 4 glass bowls Ø 14 cm 0.5 litres, 4 hinged covers with card for inscription, 1 ladder, 1 double ring, 2 single rings, easy and individual to use
set de 12 pz: 4 boles vidrio Ø 14 cm 0,5 l, 4 tapas abatibles con ventana para etiqueta, 1 soporte escalera, 1 aro doble, 2 aros sencillos, fácil montaje, se puede usar individualmente
12 éléments: 4 bols verre Ø 14 cm 0,5 l, 4 couvercles à charnière et fenêtre p/ étiquette, 1 support escalier, 1 cercle double, 2 cercles simples, montage facile, utilisable individuellement

	cm	↑ cm
11498	30 x 30	48

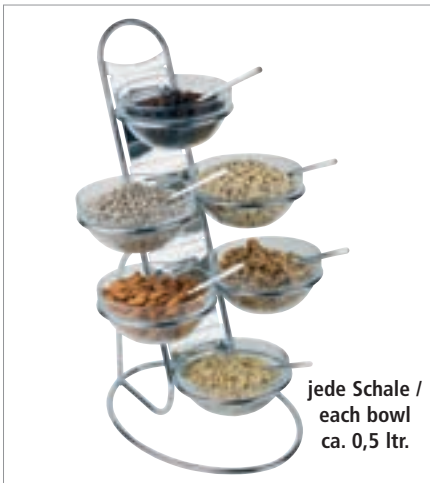

jede Schale /
each bowl
ca. 0,5 ltr.

Buffetleiter „LITTLE“

buffet ladder
dispensador en escalera
Présentoir buffet en escalier



11-teiliges Set: 6 Glasschalen Ø 14 cm 0,5 Liter, 1 Leiter, 2 Doppelringe, 2 Einzelringe, einfach und individuell zusammensetzbar
11 pcs. set: 6 glass bowls Ø 14 cm 0.5 litres, 1 ladder, 2 double rings, 2 single rings, easy and individual to use
set de 11 pz: 6 boles vidrio Ø 14 cm 0,5 l, 1 soporte escalera, 2 aros dobles, 2 aros sencillos, fácil montaje, se puede usar individualmente
11 éléments: 6 bols verre Ø 14 cm 0,5 l, 1 support escalier, 1 cercle double, 2 cercles simples, montage facile, utilisable individuellement

	cm	↑ cm
11499	30 x 30	48

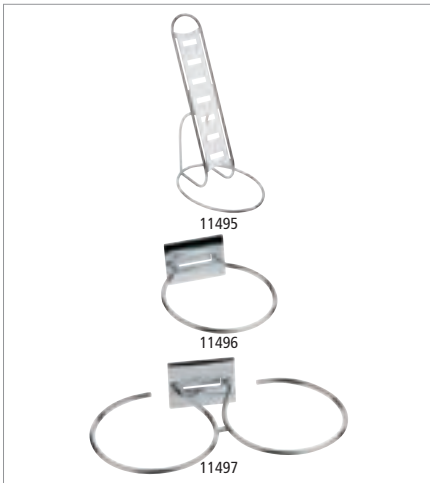

Einzelteile / spare parts / piezas sueltas / pièces détachées

Leitergestell / frame / marco solo en escalera / échelle support

11495

Einzelring / single ring / aro sencillo / cercle simple

11496

Doppelring / double ring / aro sencillo / cercle double

11497



0,5 ltr.

Schale

bowl
cuenco
bol



	Ø cm	↑ cm	ltr.
11865	14	3,5	0,5



Schutzdeckel mit Löffelaussparung

cover
tapa
couvercle



	Ø cm
11868	14,5



33245

Serviergestell

serving stand
expositor
présentoir

ohne Schalen / Körbe
without bowls / baskets
sin cuencos / cestas
sans bols / corbeilles



	Ø cm	↑ cm
33245	48	49

Schale „CASUAL MAXI“ / bowl / cuenco / bol

	Ø cm	↑ cm	ltr.	Farbe / Colour
83704	20	9,2	1,80	White
83705	20	9,2	1,80	Black



11892

Buffetständer „BIG“

buffet stand
expositor de bufé
présentoir buffet



7-teiliges Set: 3 Glasschalen Ø 23 cm 2,5 Liter, 3 klappbare Schutzdeckel, 1 Ständer
7 pcs. set: 3 glass bowls Ø 23 cm 2.5 litres, 3 hinged covers, 1 stand
7 piezas: 3 boles vidrio Ø 23 cm, 2,5 l, 3 tapas con bisagra, 1 soporte
7 éléments: 3 bols verre Ø 23 cm 2,5 l, 3 couvercles à charnière, 1 support

	cm	↑ cm
11892	50 x 50	18



83702
2,5 ltr.

Schale „CASUAL MAXI“

bowl
cuenco
bol



	Ø cm	↑ cm	ltr.	Farbe / Colour
83702	23	10,5	2,50	White
83703	23	10,5	2,50	Black



11893

Buffetständer „LITTLE“

buffet stand
expositor de bufé
présentoir buffet



7-teiliges Set: 3 Glasschalen Ø 14 cm 0,5 Liter, 3 klappbare Schutzdeckel, 1 Ständer
7 pcs. set: 3 glass bowls Ø 14 cm 0,5 l, 3 hinged covers, 1 stand
7 piezas: 3 boles vidrio Ø 14 cm, 0,5 l, 3 tapas con bisagra, 1 soporte
7 éléments: 3 bols verre Ø 14 cm 0,5 l, 3 couvercles à charnière, 1 support

	cm	↑ cm
11893	30 x 30	14



83701
0,5 ltr.

Schale „CASUAL MAXI“

bowl
cuenco
bol



	Ø cm	↑ cm	ltr.	Farbe / Colour
83700	14	6,5	0,50	White
83701	14	6,5	0,50	Black

NEW



12050
4,5 ltr.



12051
4,5 ltr.

Cerealienspender

cereal dispenser
dispensador de cereales
distributeur de céréales



Behälter herausnehmbar, portionieren durch einfaches Drehen
removable canister, easy to use, rotate the button to get the muesli
contenedor movable, fácil de usar, se gira el pomo para servir los cereales
récipient amovible, usage facile en tournant le bouton

	cm	↑ cm	ltr.	Farbe / Colour
12050	24,0 x 17,5	49,5	4,5	White
12051	24,0 x 17,5	49,5	4,5	Grey



NEW



12054
2 x 4,5 ltr.



12055
2 x 4,5 ltr.

Cerealienspender „DUO“

cereal dispenser
dispensador de cereales
distributeur de céréales



Behälter herausnehmbar, portionieren durch einfaches Drehen
removable canister, easy to use, rotate the button to get the muesli
contenedor movable, fácil de usar, se gira el pomo para servir los cereales
récipient amovible, usage facile en tournant le bouton

	cm	↑ cm	ltr.	Farbe / Colour
12054	24,0 x 37,5	49,5	2 x 4,5	White
12055	24,0 x 37,5	49,5	2 x 4,5	Grey





Buffetständer „GOOD MORNING“

buffet stand
expositor de bufé
présentoir à céréales



4-teiliges Set: Holzständer inkl. 3 Gläser mit luftdichtem Klappdeckel
4 pcs. set: wood stand included 3 glass with airtight cover
4 pz: soporte, 3 boles de cristal, cierre hermético
4 pc. présentoir, 3 bols en verre, fermeture hermétique

	cm	Farbe / Colour
13965	43 x 17	
14965	43 x 17	

Glas mit luftdichtem Klappdeckel / glass with airtight cover / cristal, cierre hermético / verre, fermeture hermétique

	cm	↑ cm	ltr.
82328	12 x 12	22	2



Cerealienspender „FRESH & EASY“

cereal dispenser
dispensador de cereales
distributeur de céréales



Behälter herausnehmbar, „Feierabend-Deckel“ für das aromadichte Lagern, portionieren durch einfaches Drehen

removable canister, special lid to keep the cereals fresh, easy to use, rotate the button to get the muesli
contenedor movable, tapa especial para mantener los cereales frescos, fácil de usar, se gira el pomo para servir los cereales
récipient amovible, couvercle spécial pour conserver les céréales, usage facile en tournant le bouton

	cm	↑ cm	ltr.
11805	22 x 17,5	52	4,5



Cerealienspender Duo „FRESH & EASY“

cereal dispenser
dispensador de cereales
distributeur de céréales



Behälter herausnehmbar, „Feierabend-Deckel“ für das aromadichte Lagern, portionieren durch einfaches Drehen

removable canister, special lid to keep the cereals fresh, easy to use, rotate the button to get the muesli
contenedor movable, tapa especial para mantener los cereales frescos, fácil de usar, se gira el pomo para servir los cereales
récipient amovible, couvercle spécial pour conserver les céréales, usage facile en tournant le bouton

	cm	↑ cm	ltr.
11807	22 x 35	52	2 x 4,5

Kunststoffbehälter / canister / contenedor / récipient

	Ø cm	ltr.
11808	24	4,5



Cerealienspender „CLASSIC“

cereal dispenser
dispensador de cereales
distributeur de céréales



Portionieren durch einfaches Drehen, Behälter herausnehmbar

canister removable
contenedor movable
récipient amovible

	cm	↑ cm	ltr.
11833	35 x 26,5	68	8



11834
2 x 8,0 ltr.

Cerealienspender „CLASSIC DUO“

cereal dispenser
dispensador de cereales
distributeur de céréales



Portionieren durch einfaches Drehen, Behälter herausnehmbar
canister removable
contenedor movable
récipient amovible

	cm	↑ cm	ltr.
11834	35 x 50	68	2 x 8



13987

14987

Cerealienspender „BRIDGE“

cereal dispenser
dispensador de cereales
distributeur de céréales



Behälter herausnehmbar, „Feierabend-Deckel“ für das aromadichte Lagern, portionieren durch einfaches Drehen
removable canister, special lid to keep the cereals fresh, easy to use, rotate the button to get the muesli
contenedor movable, tapa especial para mantener los cereales frescos, fácil de usar, se gira el pomo para servir los cereales
récipient amovible, couvercle spécial pour conserver les céréales, usage facile en tournant le bouton

	cm	↑ cm	ltr.	Farbe / Colour
13987	21 x 20	55,5	4,5	Ahorn
14987	21 x 20	55,5	4,5	Wenge



Cerealienspender „ROTATION“

cereal dispenser
dispensador de cereales
distributeur de céréales



matt poliert, drehbarer massiver Ständer, Behälter herausnehmbar, inkl. Frischhaltedeckel
satin polished finish, rotating food, canister removable, incl. airtight covers
pulido acabado satinado, giratorio, incluye tapas herméticas
mat satiné, rotatif, inclut couvercles hermétiques

	Ø cm	↑ cm	ltr.
11970	38	54	3 x 4,5

Kunststoffbehälter / canister / contenedor / récipient

11808



Cerealienspender „ROTATION“

cereal dispenser
dispensador de cereales
distributeur de céréales



Buchen-Holz versiegelt, drehbarer massiver Ständer, Behälter herausnehmbar, inkl. Frischhaltedeckel
wood beech covered waterproof, rotating foot, canister removable, incl. airtight cover

tapa en madera de haya resistente al agua, pie giratorio, recipiente removible, incluye tapa hermética
couvercle en hêtre traitée contre l'humidité, pied rotatif, récipients démontables, inclut couvercles hermétiques

	Ø cm	↑ cm	ltr.
11975	38	54	3 x 4,5

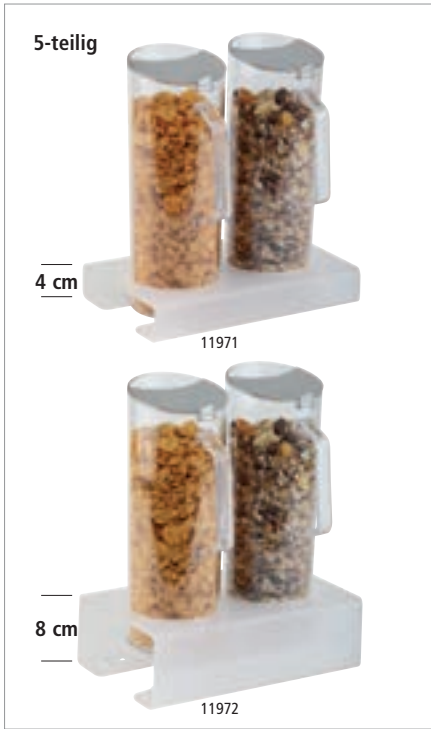

Cerealien-Bar

cereal-bar
barra para dispensador de cereales
bar à céréales



5-teiliges Set, mit Ständerhöhe 4 oder 8 cm: 1 Ständer aus Acryl gefrostet und rutschfest + 2 Karaffen mit schwenkbarem Edelstahl-Deckel + 2 luftdichte Frischhaltedeckel
5 pcs. set, with stand heights 4 or 8 cm: 1 stand acryl frosted and anti-slip + 2 pitchers with stainless steel flap lid + 2 airtight covers
set 5 piezas con stands a diferentes alturas, 4 u 8 cm: 1 stand acryl + 2 jarras con tapa de solapa de acero inoxidable + 2 tapas herméticas adicionales
set 5 éléments avec supports à différentes hauteurs: 4 ou 8 cm - 1 support acrylique satiné antiglisse + 2 pichets à céréales avec couvercle à charnière inox + 2 couvercles hermétiques

	cm	↑ cm	ltr.
11971	26 x 17	28,5	2 x 1,5
11972	26 x 17	32,5	2 x 1,5



ideal für Stufenpräsentation
best for staged presentations

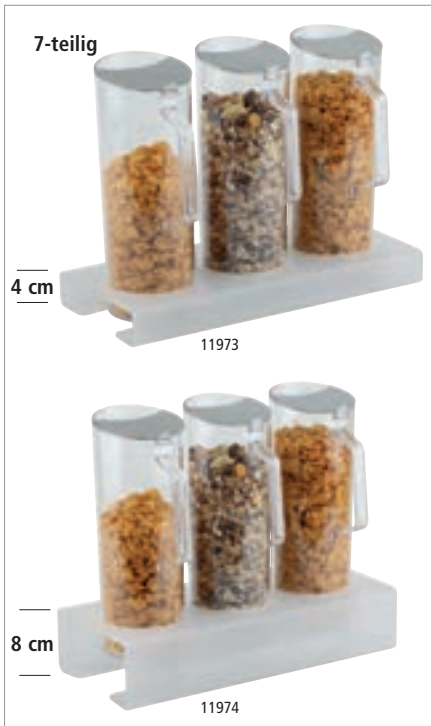

Cerealien-Bar

cereal-bar
barra para dispensador de cereales
bar à céréales



7-teiliges Set, mit Ständerhöhe 4 oder 8 cm: 1 Ständer aus Acryl gefrostet und rutschfest + 3 Karaffen mit schwenkbarem Edelstahl-Deckel + 3 luftdichte Frischhaltedeckel
7 pcs. set, with stand heights 4 or 8 cm: 1 stand acryl frosted and anti-slip + 3 pitchers with stainless steel flap lid + 3 airtight covers
set 7 piezas con stands a diferentes alturas, 4 u 8 cm: 1 stand acryl + 3 jarras con tapa de solapa de acero inoxidable + 3 tapas herméticas adicionales
set 7 éléments avec supports à différentes hauteurs: 4 ou 8 cm - 1 support acrylique satiné antiglisse + 3 pichets à céréales avec couvercle à charnière inox + 3 couvercles hermétiques

	cm	↑ cm	ltr.
11973	38 x 17	28,5	3 x 1,5
11974	38 x 17	32,5	3 x 1,5



ideal für Stufenpräsentation
best for staged presentations



Cerealienkaraffe

cereal pitcher
jarra de cereales
pichet à céréales



schwenkbarer Edelstahl-Deckel, inkl. luftdichtem Frischhaltedeckel
stainless steel flap lid, incl. 1 airtight cover
tapa de solapa de acero inoxidable, incluye otra tapa hermética
couvercle à charnière inox + couvercle hermétique

	Ø cm	↑ cm	ltr.
10778	10	28	1,5

Frishhaltedeckel / conservation lid / tapa de conservación / couvercle

10668

SERVICE TOWER



Service Tower

service tower
service tower
tour de service



Präsentations- und Spendersystem, bei minimalen Platzbedarf, optimale Wertschöpfung, zum Beispiel im Bereich der Besteckausgabe, Kaffeestationen, Speiseausgaben, Verkaufstheken, etc., Rückwand aus dunklem Holz oder Acryl gefrostet

Presentation and dispenser system, the products find their best creation of value at minimal need of space, for example in the range of coffeestations, food service, counters etc., backplane made of dark wood or acrylic frosted

sistema de presentación y dispensador, con el mínimo espacio conseguirá una excelente presentación de sus productos, por ejemplo en la zona del café, comidas, etc., trasera de madera oscura o de acrílico opaco mate

système de présentation et distribution, très élégant dans un espace minimum, idéal pour la zone café, coin repas, etc., paroi en bois foncé ou en acrylique mat

	cm	↑ cm	Farbe / Colour	
11431	26 x 18	43	■	2x Schütte, tief + 1x Schütte, flach 2 deep ones + 1 flat one 2 rampas hondas + 1 plana / 2 rampas profundes + 1 plates
11432	26 x 18	43	■	3x Schütte, tief / 3 bowls, deep ones 3 rampas hondas / 3 rampas profundes
11422	26 x 18	57,5	■	4x Schütte, tief / 4 bowls, deep ones 4 rampas hondas / 4 rampas profundes

	cm	↑ cm	Farbe / Colour	
11433	26 x 18	43	■	2x Schütte, tief + 1x Schütte, flach / 2 deep ones + 1 flat one / 2 rampas hondas + 1 plana / 2 rampas profundes + 1 plate
11434	26 x 18	43	■	3x Schütte, tief / 3 bowls, deep ones 3 rampas hondas / 3 rampas profundes
11424	26 x 18	57,5	■	4x Schütte, tief / 4 bowls, deep ones 4 rampas hondas / 4 rampas profundes

Basisfuss / base / pie de la base / pied de la base

11435

Rückwand Holz / backplane made of wood / trasera de madera / arrière bois

cm

11436 44,5 x 24 für 3 Schütten

11426 60 x 24 für 4 Schütten

Rückwand Acryl / backplane made of acrylic / trasera acrílica / arrière acrylique

cm

11437 44,5 x 24 für 3 Schütten

11427 60 x 24 für 4 Schütten

Schütte, tief / bowl, deep / rampa, honda / rampe profonde

cm

↑ cm

11438 22 x 14 7 / 5

Schütte, flach / bowl / rampa plana / rampe plate

cm

↑ cm

11439 22 x 13 3 / 1



MULTI RACK



Multi Rack
multi rack
dispensador en escalera
support multiple



2-stufig, 3-teilig: 1 Gestell matt poliert + 2 Schütten aus transparent gefroretetem Kunststoff, je ca. 1 Liter

2-tier, 3 pcs. set: 1 frame satin polished finish + 2 bowls frosted plastic, approx. 1 liter
2 alturas - set de 3 pz: 1 soporte inox mate satinado + 2 bols plástico glaseado, aprox. 1 litro
2 niveaux - set de 3 éléments: 1 support satiné + 2 bols plastique mat, approx. 1 litre

	cm	↑ cm
11442	19 x 24	28



Multi Rack
multi rack
dispensador en escalera
support multiple



3-stufig, 4-teilig: 1 Gestell matt poliert + 3 Schütten aus transparent gefroretetem Kunststoff, je ca. 1 Liter

3-tier, 4 pcs. set: 1 frame satin polished finish + 3 bowls frosted plastic, approx. 1 liter
3 alturas, set de 4 piezas: 1 estructura inox satinado + 3 bols de plástico glaseado, aprox. 1 litro
3 niveaux - set de 4 éléments: 1 structure inox poli satin, 3 bols plastique mat, approx. 1 litre

	cm	↑ cm
11444	19 x 24	41



Multi Rack
multi rack
dispensador en escalera
support multiple



3-stufig, 4-teilig: 1 Gestell matt poliert + 1 Schütte aus transparent gefroretetem Kunststoff, ca. 1 Liter + 2 Rutschen aus transparent gefroretetem Kunststoff

3-tier, 4 pcs. set: 1 frame satin polished finish + 1 bowl frosted plastic, approx. 1 liter + 2 slides frosted plastic
3 alturas, set de 4 piezas, 1 soporte inox satinado + 1 bol de plástico glaseado, aprox, 1 litro + 2 bols con „tobogán“ en plástico glaseado
3 niveaux - set de 4 éléments: 1 structure inox poli satin + 1 bol plastique mat approx. 1 litre + 2 bols avec „toboggan“

	cm	↑ cm
11449	19 x 24	41



Multi Rack
multi rack
dispensador en escalera
support multiple



4-stufig, 5-teilig: 1 Gestell matt poliert + 4 Schütten aus transparent gefroretetem Kunststoff, je ca. 1 Liter

4-tier, 5 pcs. set: 1 frame satin polished finish + 4 bowls frosted plastic, approx. 1 liter
4 alturas, set de 5 piezas: 1 estructura inox satinado + 4 bols de plástico glaseado, aprox. 1 litro
4 niveaux - set de 5 éléments: 1 structure inox poli satin, 4 bols plastique mat, approx. 1 litre

	cm	↑ cm
11446	19 x 31	53



Multi Rack
multi rack
dispensador en escalera
support multiple



4-stufig, 5-teilig: 1 Gestell matt poliert + 3 Schütten aus transparent gefroretetem Kunststoff, je ca. 1 Liter + 1 Rutsche aus transparent gefroretetem Kunststoff
4-tier, 5 pcs. set: 1 frame satin polished finish + 3 bowls frosted plastic, approx. 1 liter + 1 slide frosted plastic
4 alturas, set de 5 piezas: 1 estructura inox satinado + 3 bols de plástico glaseado, aprox. 1 litro + 1 bol con „tobogán“ de plástico efecto glaseado
4 niveaux - set de 5 éléments: 1 structure inox poli satin + 3 bols plastique mat approx. 1 litre + 1 bol avec „tobogán“

	cm	↑ cm
11451	19 x 31	53



Schütte

Ergänzung für alle Multi-Racks
supplement for all multi racks
suplemento para todos los dispensadores
compléments pour support Multi-Rack



11455	Schütte / canister / bol / bol
-------	--------------------------------



Rutsche

Ergänzung für alle Multi-Racks
supplement for all multi racks
suplemento para todos los dispensadores
compléments pour support Multi-Rack



11456	Rutsche / slide / tobogan / toboggan
-------	--------------------------------------

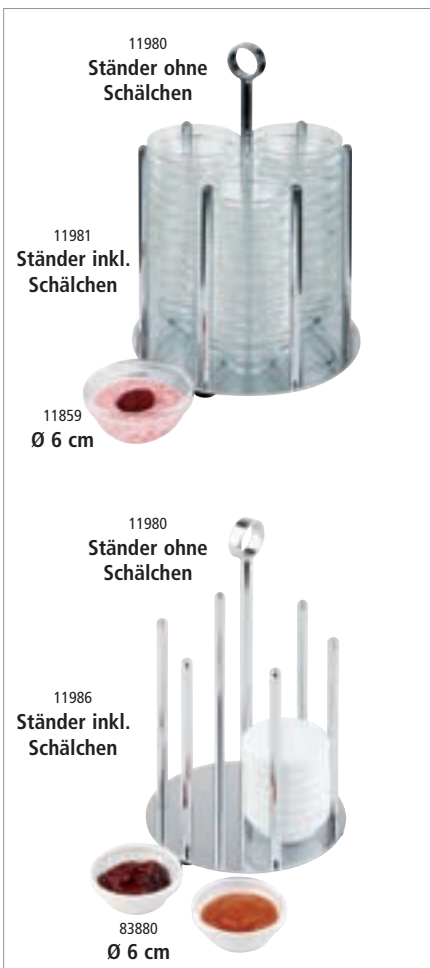

Schälchenspender „MINI“

bowl holder
rack dispensador para bols
porte-bols



geeignet für Schalen Ø 6 cm, bestückbar mit bis zu 36 Schalen
for bowls Ø 6 cm, suitable for 36 bowls
para bols de Ø 6 cm, apto para 36 bols
pour bols de Ø 6 cm, maxi 36 bols

	Ø cm	↑ cm	
11981	14	25,5	Ständer inkl. 36 Glasschalen, Ø 6 cm / frame with 36 bowls, Ø 6 cm soporte con 36 bols, Ø 6 cm / support livré avec 36 bols en verre Ø 6 cm
11986	14	25,5	Ständer inkl. 36 Melaminschalen, Ø 6 cm / frame with 36 melamine bowls, Ø 6 cm soporte con 36 bols de melamina Ø 6 cm / support avec 36 bols en mélamine Ø 6 cm

Schälchenspender „MINI“ / bowl holder / rack dispensador para bols / porte-bols

	Ø cm	↑ cm	
11980	14	25,5	Ständer ohne Schalen / frame without bowls soporte sin bols / support sans bols

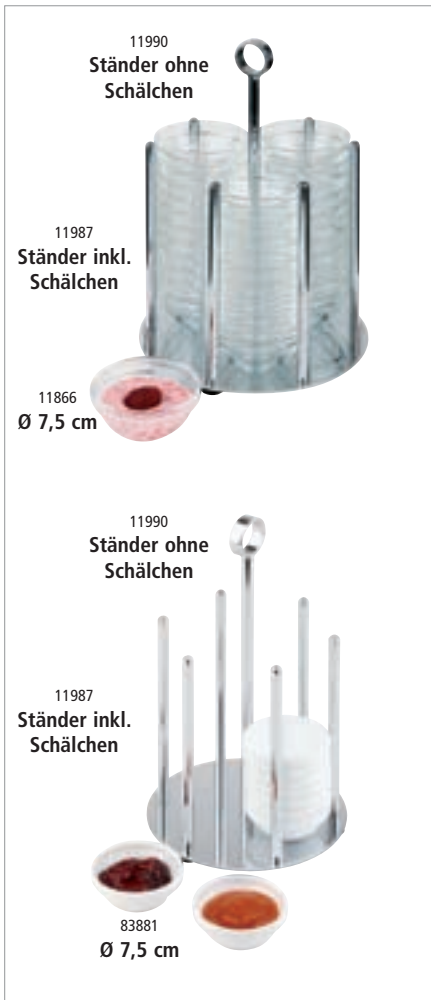

Schälchenspender „MEDIUM“

bowl holder
rack dispensador para bols
porte-bols



geeignet für Schalen Ø 7,5 cm, bestückbar mit bis zu 36 Schalen
for bowls Ø 7,5 cm, suitable for 36 bowls
para bols de Ø 7,5 cm, apto para 36 bols
pour bols de Ø 7,5 cm, maxi 36 bols

	Ø cm	↑ cm	
11991	17,5	25,5	Ständer inkl. 36 Glasschalen, Ø 7,5 cm / frame with 36 bowls, Ø 7,5 cm soporte con 36 bols, Ø 7,5 cm / support livré avec 36 bols en verre Ø 7,5 cm
11987	17,5	22,5	Ständer inkl. 36 Melaminschalen, Ø 7,5 cm / frame with 36 melamine bowls, Ø 7,5 cm soporte con 36 bols de melamina, Ø 7,5 cm / support avec 36 bols en mélamine Ø 7,5 cm

Schälchenspender „MEDIUM“ / bowl holder / rack dispensador para bols / porte-bols

	Ø cm	↑ cm	
11990	17,5	25,5	Ständer ohne Schalen / frame without bowls soporte sin bols / support sans bols



Schälchen „CASUAL MINI“

bowl
cuenco
bol mini



	Ø cm	↑ cm	litr.
83880	6,0	2,5	0,02
83881	7,5	3,5	0,05



Schale

bowl
cuenco
bol



	Ø cm	↑ cm	litr.
11859	6,0	2,5	0,05
11866	7,5	6,5	0,09



Käseglocken-Set „BRAZIL“

rolltop set
set rolltop
set cloche á fromage



3-teilig: Tablett + Holzschneidebrett + Rolltophaube glasklar, rutschfeste Haubenfixierung

3 pcs. set: tray + wooden board + rolltop cover, cover non-slip fixed
set de 3 piezas: bandeja + tablero de madera + campana abatible, fijación antideslizante
set de 3 pièces: plateau + planche à découper + cloche abattante, fixation antiglisse

	Ø cm	↑ cm
09085	45	24



Rolltop-Set

rolltop set
set rolltop
set cloche à fromage



2-teilig: Tablett + Rolltophaube glasklar, rutschfeste Haubenfixierung, klappbar

2 pcs. set: tray + rolltop cover, cover non-slip fixed, mountable
set de 2 piezas: bandeja + campana abatible fijación antideslizante, montable
set de 2 pièces: plateau + cloche abattante, fixation antiglisse, montable

	Ø cm	↑ cm
09080	38	24
09099	50	28



Rolltop-Set

rolltop set
set rolltop
set rolltop



2-teilig: Schneidbrett marmoriert + Rolltophaube glasklar, rutschfeste Haubenfixierung, klappbar

2 pcs. set: plastic board + rolltop cover, cover non-slip fixed, mountable
set de 2 piezas: tablero de plástico + tapa abatible, tapa antideslizante, montable
set de 2 pièces: planche à découper + cloche abattante, fixation antiglisse, montable

	Ø cm	↑ cm
09081	38	24



Buffet-Set

buffet set
set de bufé
présentoir pour le buffet



2-teilig: Platte + Rolltophaube, schneidfeste und porenfreie Oberfläche, rutschfeste Haubenfixierung, Platte mit rutschfesten Füßen

2 pcs. set: glass board + rolltop cover, scratch-resistant surface, cover non-slip fixed, non-slip feet
set de 2 piezas: bandeja vidrio redonda + campana abatible, fijación antideslizante, pies antideslizantes

set de 2 pièces: plateau verre rond + cloche abattante, fixation antiglisse et pieds antidérapants

	Ø cm	↑ cm
00978	38	23

Rolltop-Haube mit Löchern / rolltop cover / campana abatible / cloche basculante

	Ø cm	↑ cm
18394	38	20

Glasplatte / glass plate / bandeja de vidrio / plateau verre

	Ø cm	↑ cm
00972	38	3



Buffetvitrine

showcase
vitrina de bufé
vitrine de buffet



1 transparente Rolltophaube beidseitig aufklappbar + 1 Schale (ABS)
+ 1 Edelstahl-Tablett 39 x 28 cm + 2 Kühl-Akkus

1 transparent rolltop cover + 1 tray (ABS) + 1 stainless tray 39 x 28 cm + 2 coolers, demountable
1 tapa abatible transparente + 1 bandeja (ABS) + 1 bandeja 39x28cm + 2 enfriadores, desmontable
1 cloche transparente ouverture 2 côtés + 1 caisson (ABS) + 1 plateau inox 39 x 28 cm + 2 accumulateurs de froid, démontable

	cm	↑ cm	Farbe / Colour
09100	44 x 32	20,5	White
09102	44 x 32	20,5	Blue
09104	44 x 32	20,5	Black

Kühlakku / cooler / acumulador de frío / accumulateur de froid

	cm	↑ cm	pcs.
11101	16 x 7,5	2,0	4

Edelstahl-Tablett / stainless steel tray / bandeja de acero inoxidable / plateau inox

	cm
90902	39 x 28



Thermo Tablett-Set

thermo tray
bandeja termo
caisson thermo



1 stabile Schale + 1 Edelstahl-Tablett + 2 Kühlakkus + 1 Frischhaltehaube

1 plastic tray + 1 stainless tray + 2 coolers + 1 cover
1 bandeja de plástico + 1 bandeja inox + 2 acumuladores + 1 campana
1 plateau plastique + 1 plateau inox + 2 accumulateurs de froid + 1 cloche

	cm	↑ cm
09090	43 x 29	14

Kühlakku / cooler / acumulador de frío / accumulateur de froid

	cm	↑ cm	pcs.
11101	16 x 7,5	2,0	4

Haube / cover / campana / cloche

	cm	↑ cm
90901	43 x 29	14

Edelstahl-Tablett / stainless steel tray / bandeja de acero inoxidable / plateau inox

	cm
90902	39 x 28

Kühl-Akkus halten Ihre Speisen bis zu 6 Stunden kühl



Buffetvitrine „DOPPELDECKER“

showcase
vitrina de bufé, 2 alturas
vitrine de buffet double



2 transparente Rolltophauben beidseitig aufklappbar + 2 Edelstahl-Tablets 39 x 28 cm
+ 4 Kühl-Akkus, platzsparend lagerbar
2 transparent rolltop cover + 2 tray 39 x 28 cm + 4 coolers, demountable, space saving
2 campanas abatibles por ambos lados + 2 bandejas 39 x 28 cm + 4 acumuladores, desmontable, ahorra espacio
2 cloches transparentes abattantes 2 côtés + 2 plateaux 39 x 28 cm + 4 accumulateurs de froid, gain d'espace

	cm	↑ cm	Farbe / Colour
09200	44 x 32	44	White
09202	44 x 32	44	Blue
09204	44 x 32	44	Black

Kühlakku / cooler / acumulador de frío / accumulateur de froid

	cm	↑ cm	pcs.
11101	16 x 7,5	2,0	4

Edelstahl-Tablett / stainless steel tray / bandeja de acero inoxidable / plateau inox

	cm
90902	39 x 28



Thermo Tablett-Set

thermo tray
bandeja termo
caisson thermo



1 stabile Schale + 1 Edelstahl-Tablett + 2 Kühlakkus + 1 Frischhaltehaube
1 plastic tray + 1 stainless tray + 2 coolers + 1 cover
1 bandeja de plástico + 1 bandeja inox + 2 acumuladores + 1 campana
1 plateau plastique + 1 plateau inox + 2 accumulateurs de froid + 1 cloche

	Ø cm	↑ cm
09093	35	15

Kühlakku / cooler / acumulador de frío / accumulateur de froid

	cm	↑ cm	pcs.
11101	16 x 7,5	2,0	4

Kühl-Akkus halten Ihre Speisen bis zu 6 Stunden kühl



Buffetvitrine „TOP FRESH GN 1/1“

refrigerated buffet display
expositor bufé frío
plateau buffet froid



4-teilig: 1 Holzbox mit Kunststoffwanne + 1 Tablett GN 1/1 + 2 Kühllakkus
4 pcs. set: 1 woodbox with plastic insert + 1 stainless tray GN 1/1 + 2 coolers
set de 4 piezas: 1 base madera + 1 bandeja inox GN 1/1 + 2 acumuladores de frío
set de 4 pièces: 1 base bois + 1 plateau inox GN 1/1 + 2 accus de froid (cloche non incluse)

	cm	↑ cm
11540	60 x 41	5

GN Rolltophaube / GN rolltop cover / GN campana rolltop / GN cloche rolltop

	cm	↑ cm	GN	
11008	53,0 x 32,5	19	1/1	Gold-Griff

GN Rolltophaube / GN rolltop cover / GN campana rolltop / GN cloche rolltop

	cm	↑ cm	GN	
11010	53,0 x 32,5	19	1/1	Chrom-Griff

Kühllakku / cooler / acumulador de frío / accumulateur de froid

	cm	↑ cm
10791	25 x 19	2,5



Buffetvitrine „DOPPELDECKER“

cooling buffet display
expositor bufé frío
vitrine buffet



12-teilig: 2 Kästen Buchen-Holz versiegelt + 2 Tablett GN 1/1 + 4 Kühllakkus + 4 Stangen, ohne Hauben

12 pcs. set: 2 beech wood boxes waterproof + 2 trays GN 1/1 + 4 coolers + 4 fittings, without covers

set de 12 piezas: 2 bases madera tratada + 2 bandejas inox GN 1/1 + 4 enfriadores + 4 pies (campanas no incl.)

set de 12 pièces: 2 caissons bois traité (hêtre) + 2 plateaux inox GN 1/1 + 4 accus + 4 pieds (cloches non incluses)

	cm	↑ cm	
11541	60 x 41	36	verchromte Stäbe / chrome plated fittings pies cromados / pieds chromés

GN Rolltophaube / GN rolltop cover / GN campana rolltop / GN cloche rolltop

	cm	↑ cm	GN	
11008	53,0 x 32,5	19	1/1	Gold-Griff

GN Rolltophaube / GN rolltop cover / GN campana rolltop / GN cloche rolltop

	cm	↑ cm	GN	
11010	53,0 x 32,5	19	1/1	Chrom-Griff

Kühllakku / cooler / acumulador de frío / accumulateur de froid

	cm	↑ cm
10791	25 x 19	2,5



11542

18388

Buche, wasserfest lackiert

10791

Kühl-Akkus halten Ihre Speisen bis zu 6 Stunden kühl

Kühltablett „TOP FRESH RUND“

refrigerated buffet display
expositor bufé frío redondo
présentoir buffet



3-teilig: 1 Holzbox mit Kunststoffwanne + 1 Edelstahl-Tablett Ø 38 cm + 1 Kühlakku

3 pcs. set: 1 woodbox with plastic insert + 1 stainless tray Ø 38 cm + 1 cooler

set de 3 piezas: 1 caja madera + 1 bandeja inox Ø 38 cm + 1 acumulador de frío

set de 3 pièces: 1 base bois + 1 plateau inox Ø 38 cm + 1 accumulateur de froid

	Ø cm	↑ cm	cl
11542	48	6	

Rolltophaube / rolltop cover / campana abatible / cloche basculante

	Ø cm	↑ cm
18388	38	20

Rolltophaube / rolltop cover / campana abatible / cloche basculante

	Ø cm	↑ cm
18387	38	20

Kühlakku / cooler / acumulador de frío / accumulateur de froid

	cm	↑ cm
10791	25 x 19	2,5



18388

18388

11543

10791

Kühl-Akkus halten Ihre Speisen bis zu 6 Stunden kühl

Buffetvitrine „DOPPELDECKER“

double refrigerated buffet display
expositor de bufé redondo doble
présentoir buffet froid, double



11-teilig: 2 Rahmen Buchen-Holz versiegelt + 2 Edelstahl-Tablets Ø 38 cm

+ 2 Kühlakkus + 2 Kunststoffschalen + 3 Stangen, ohne Hauben

11 pcs. set: 2 beech wood boxes waterproof + 2 stainless trays Ø 38 cm + 2 cooler + 2 plastic deep trays + 3 fittings, without covers

set de 11 piezas: 2 bases madera + 2 bandejas inox aprox. 38cm + 2 acumuladores + 2 cubetas plástico + 3 varas (campanas no incl.)

set de 11 pièces: 2 caissons bois traité (hêtre) + 2 plateaux inox approx. 38 cm + 2 accus + 2 bacs plastique + 3 barres (cloches non incluses)

	Ø cm	↑ cm	
11543	48	38	verchromte Stäbe / chrome fittings pies cromados / pieds chromés

Rolltophaube / rolltop cover / campana abatible / cloche basculante

	Ø cm	↑ cm
18388	38	20

Rolltophaube / rolltop cover / campana abatible / cloche basculante

	Ø cm	↑ cm
18387	38	20

Kühlakku / cooler / acumulador de frío / accumulateur de froid

	cm	↑ cm
10791	25 x 19	2,5



Buffetvitrine „TOP FRESH GN 1/1“

cooling buffet display
expositor bufé frío
présentoir buffet



5-teilig: 1 Edelstahl-Tablett GN 1/1 + 2 Kühllakkus + 1 Edelstahl-Schale + 1 Acrylrahmen, ohne Haube

5 pcs. set: 1 stainless tray GN 1/1 + 2 cooler + 1 stainless deep tray + 1 frame acrylic, without cover

set de 5 piezas: 1 bandeja inox GN 1/1 + 2 acumuladores + 1 cubeta inox + 1 marco metacrilato (campana no incl.)

set de 5 pièces: 1 plateau inox GN 1/1 + 2 accus. de froid + 1 bac inox + 1 cadre plexi (cloche non-incl.)

	cm	↑ cm
11510	61 x 38	8

GN Rolltophaube / GN rolltop cover / GN campana rolltop / GN cloche rolltop

	cm	↑ cm	GN
11010	53,0 x 32,5	19	1/1

Kühllakku / cooler / acumulador de frío / accumulateur de froid

	cm	↑ cm
10791	25 x 19	2,5



Buffetvitrine „DOPPELDECKER“

cooling buffet display
expositor bufé frío
présentoir buffet



14-teilig: 2 Edelstahl-Tablets GN 1/1 + 4 Kühllakkus + 2 Edelstahl-Schale

+ 2 Acrylrahmen + 4 verchromte Stangen, ohne Hauben

14 pcs. set: 2 stainless tray GN 1/1 + 4 cooler + 2 stainless deep trays + 2 frames acrylic + 4 chrome plated fittings, without covers

set de 14 piezas: 2 bandejas inox GN 1/1 + 4 acum. de frío 2 cubetas inox + 2 bases metacrilato + 4 varas cromadas (sin las campanas)

set de 14 pièces: 2 plateaux inox GN 1/1 + 4 accus 2 bacs inox + 2 cadres plexi + 4 barres chromées (sans les cloches)

	cm	↑ cm
11514	61 x 38	33

GN Rolltophaube / GN rolltop cover / GN campana rolltop / GN cloche rolltop

	cm	↑ cm	GN
11010	53,0 x 32,5	19	1/1

Kühllakku / cooler / acumulador de frío / accumulateur de froid

	cm	↑ cm
10791	25 x 19	2,5



Kühltablett „TOP FRESH RUND“

cooling plate
expositor bufé frío
présentoir buffet



4-teilig: 1 Edelstahl-Tablett Ø 38 cm + 2 Kühllakku + 1 Edelstahl-Schale + 1 Acrylrahmen, ohne Haube

4 pcs. set: 1 stainless tray Ø 38 cm + 2 cooler + 1 stainless deep tray + 1 frame acrylic, without cover

set de 4 piezas: 1 bandeja inox 38cm + 2 acum. de frío + 1 cubeta inox + 1 base metacrilato (campana no incluida)

set de 4 pièces: 1 plateau inox 38cm + 2 accum. de froid + 1 bac inox + 1 base plexi (cloche non incl.)

	Ø cm	↑ cm
11512	43,5	8

Rolltophaube / rolltop cover / campana abatible / cloche basculante

	Ø cm	↑ cm
18388	38	20

Kühllakku / cooler / acumulador de frío / accumulateur de froid

	cm	↑ cm	pcs.
11101	16 x 7,5	2,0	4



Buffetvitrine „DOPPELDECKER“

cooling plate
expositor de bufé doble redondo
présentoir buffet



13-teilig: 2 Edelstahl-Tablets Ø 38 cm + 4 Kühllakku + 2 Edelstahl-Schalen + 2 Acrylrahmen + 3 verchromte Stangen, ohne Hauben

13 pcs. set: 2 stainless trays Ø 38 cm + 4 cooler + 2 stainless deep tray + 2 frames acrylic + 3 chrome plated fittings, without covers

set de 13 piezas: 2 bandejas inox 38 cm + 4 acumuladores de frío + 3 varas cromadas + 2 bases + 2 bandejas, campana no incluida.

set de 13 pièces: 2 plateaux inox 38cm + 4 accum. de froid + 2 bacs inox + 2 bases plexi + 3 barres chromées (cloche non incl.)

	Ø cm	↑ cm
11516	43,5	33

Rolltophaube / rolltop cover / campana abatible / cloche basculante

	Ø cm	↑ cm
18388	38	20

Kühllakku / cooler / acumulador de frío / accumulateur de froid

	cm	↑ cm	pcs.
11101	16 x 7,5	2,0	4



Kühlbox „TOP FRESH GN 1/1“

cooling plate
bandeja de frío
présentoir buffet réfrigéré



4-teilig: 1 Kühlbox + 1 Tablett GN 1/1 + 2 Kühlakkus, ohne Haube

4 pcs. set: 1 box + 1 tray GN 1/1 + 2 coolers, without cover

set de 4 piezas: 1 caja plástico blanco + 1 bandeja GN 1/1 + 2 acum. de frío, campana no incluida

set de 4 pièces: 1 caisson plastique blanc + 1 plateau GN 1/1 + 2 accum. de froid (cloche non incl.)

	cm	↑ cm	Farbe / Colour
11503	56,5 x 35	6,5	White
11505	56,5 x 35	6,5	Black

GN Rolltophaube / GN rolltop cover / GN campana rolltop / GN cloche rolltop

	cm	↑ cm	GN
11008	53,0 x 32,5	19	1/1

GN Rolltophaube / GN rolltop cover / GN campana rolltop / GN cloche rolltop

	cm	↑ cm	GN
11010	53,0 x 32,5	19	1/1

Kühlakku / cooler / acumulador de frío / accumulateur de froid

	cm	↑ cm
10791	25 x 19	2,5

GN Edelstahl-Tablett „PROFI LINE“ / GN tray / GN bandeja / GN plat empilable système catering

	cm	↑ cm	GN
11100	53,0 x 32,5	1,5	1/1

In der Box sorgt der Kühlakku für eine beständige Frische für Wurst, Käse, etc.



Kühlbox „TOP FRESH“

cooling box
expositor buffet frío
présentoir buffet



4-teilig: 1 Kühlbox + 1 Tablett GN 1/1 + 2 Kühlakkus, ohne Haube

4 pcs. set: 1 box + 1 tray GN 1/1 + 2 cooler, without rolltop cover

set de 4 piezas: 1 cajón + 1 bandeja GN 1/1 + 2 enfriadores, campana no incluida

set de 4 pièces: 1 caisson inférieur + 1 plateau GN 1/1 + 2 accus, cloche non incluse

	cm	↑ cm
11590	56,5 x 36	8,5

GN Rolltophaube / GN rolltop cover / GN campana rolltop / GN cloche rolltop

	cm	↑ cm	GN
11008	53,0 x 32,5	19	1/1

GN Rolltophaube / GN rolltop cover / GN campana rolltop / GN cloche rolltop

	cm	↑ cm	GN
11010	53,0 x 32,5	19	1/1

Kühlakku / cooler / acumulador de frío / accumulateur de froid

	cm	↑ cm
10791	25 x 19	2,5

Schneidebrett / cutting board / tabla de corte / planche à découper

	cm	↑ cm
00901	47,5 x 26,5	1



Kühlbox „TOP FRESH SET“

cooling plate
bandeja de frío
set frigifère



3-teilig: 1 Box + 1 Tablett Ø 38 cm + 1 Kühlakku, ohne Haube
3 pcs. set: 1 box + 1 tray Ø 38 cm + 1 cooler, without cover
set de 3 piezas: 1 caja + 1 bandeja Ø 38 cm + 1 enfriador, sin tapa
set de 3 pièces: 1 caisson + 1 plateau Ø 38 cm + 1 accum. (livré sans la cloche)

	Ø cm	↑ cm	Farbe / Colour
11538	42	6	White
11533	42	6	Black

Rolltophaube / rolltop cover / campana abatible / cloche basculante

	Ø cm	↑ cm
18388	38	20

Kühlakku / cooler / acumulador de frío / accumulateur de froid

	cm	↑ cm
10791	25 x 19	2,5



Thermo-Set

thermo set
bandeja isotérmica
set thermo



5-teilig: 1 Tablett tief + 1 Tablett flach + 2 Kühlakkus + 1 Rolltophaube
5 pcs. set: 1 deep tray + 1 tray + 2 cooler + 1 rolltop cover
set de 5 piezas: 1 bandeja inferior + 1 bandeja + 2 acumuladores frío + campana
set de 5 pièces: 1 plateau creux + 1 plateau plat + 2 accum. + 1 cloche rolltop

	Ø cm	↑ cm
09082	38	24

Rolltophaube / rolltop cover / campana abatible / cloche basculante

	Ø cm	↑ cm
18388	38	20

Kühlakku / cooler / acumulador de frío / accumulateur de froid

	cm	↑ cm	pcs.
11101	16 x 7,5	2,0	4



Thermo-Set

thermo set
porta tartas refrigerado
porte-gâteau réfrigéré



4-teilig: 1 Tablett tief auf Fuß + 1 Tablett flach + 2 Kühlakkus
4 pcs. set: 1 deep tray with feet + 1 tray + 2 cooler
set de 4 piezas: 1 bandeja honda con pie + 1 bandeja + 2 acumuladores de frío
set de 4 pièces: 1 plateau creux avec pied + 1 plateau plat + 2 accum.

	Ø cm	↑ cm
09083	38	14,5

Rolltophaube / rolltop cover / campana abatible / cloche basculante

	Ø cm	↑ cm
18388	38	20

Kühlakku / cooler / acumulador de frío / accumulateur de froid

	cm	↑ cm	pcs.
11101	16 x 7,5	2,0	4

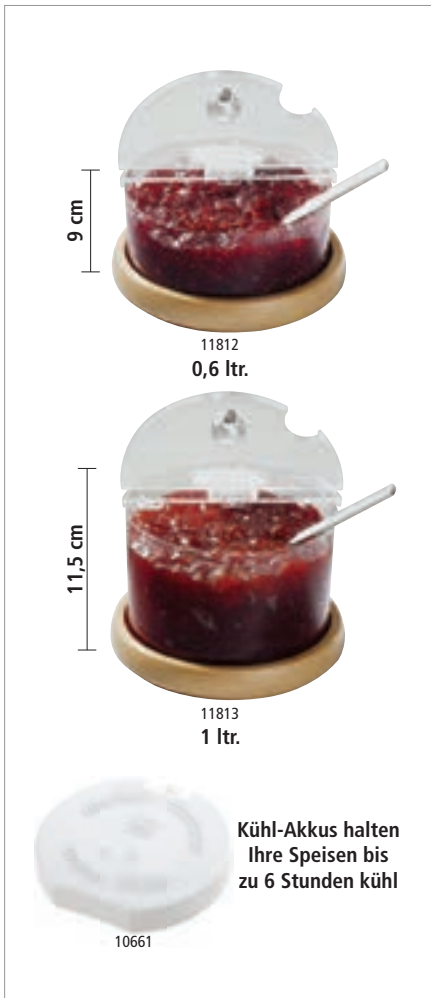

Kühlschale Mini Holz „TOP FRESH“

cool bowl mini holz
bol refrigerado mini madera
bol réfrigéré MINI bois



4-teilig: 1 Fuß Buchen-Holz versiegelt + 1 Schale + 1 Kühlakku + 1 klappbarer Deckel mit Beschriftungsschild

4 pcs. set: 1 column with food base (beech) + 1 bowl + 1 cooler + 1 cover with card, hinged
set de 4 piezas: 1 bol polycarbonato + 1 base madera + 1 acum. de frío + 1 tapa con bisagra y porta etiqueta

set de 4 pièces : 1 base en bois + 1 acum + 1 bol polycarbonate + 1 couvercle à charnière avec porte-étiquette

	Ø cm	↑ cm	ltr.
11812	14	9	0,6
11813	14	11,5	1

Ersatzschale / spare bowl / recambio bol / bol de rechange

	Ø cm	↑ cm
11811	14	6,5
11816	14	9

Schutzdeckel mit Löffelaussparung / cover / tapa / couvercle

	Ø cm
11868	14,5

Kühlakku / cooler / acumulador de frío / accumulateur de froid

	Ø cm	↑ cm
10661	10,5	2,0



Kühlschale Maxi Holz „TOP FRESH“

cool bowl maxi holz
bol refrigerado MAXI madera
bol réfrigéré MAXI bois



4-teilig: 1 Fuß Buchen-Holz versiegelt + 1 Schale + 1 Kühlakku + 1 klappbarer Deckel mit Beschriftungsschild

4 pcs. set: 1 column with food base (beech) + 1 bowl + 1 cooler + 1 cover with card, hinged
set de 4 piezas: 1 bol + 1 base madera + 1 acumulador de frío + 1 tapa con bisagra y porta etiqueta

set de 4 pièces : 1 base en bois + 1 acum. + 1 bol + 1 couvercle à charnière avec porte-étiquette

	Ø cm	↑ cm	ltr.
11817	22	14	2,5
11818	22	18	4

Ersatzschale / spare bowl / recambio bol / bol de rechange

	Ø cm	↑ cm
11846	22	8
11848	22	12

Schutzdeckel mit Löffelaussparung / cover / tapa / couvercle

	Ø cm
11878	23,5

Kühlakku / cooler / acumulador de frío / accumulateur de froid

	Ø cm	↑ cm
10777	15	2,5



Kühlschale Mini „TOP FRESH“

cool bowl mini
bol refrigerado MINI
bol réfrigéré MINI



4-teilig: 1 Edelstahlgefäß matt + 1 Kühlakku + 1 Schale + 1 klappbarer Deckel mit Beschriftungsschild

4 pcs. set: 1 column satin polished finish + 1 cooler + 1 bowl + 1 cover with card, hinged
set de 4 piezas: 1 base acabado efecto satinado + 1 acumulador de frío + 1 tapa con porta etiqueta + 1 bol

set de 4 pièces: 1 base inox mat satiné + 1 accum. de froid + 1 couvercle à charnière avec porte étiquette + 1 bol

	Ø cm	↑ cm	ltr.
11810	14	9	0,6
11815	14	11,5	1

Ersatzschale / spare bowl / recambio bol / bol de rechange

	Ø cm	↑ cm
11811	14	6,5
11816	14	9

Schutzdeckel mit Löffelaussparung / cover / tapa / couvercle

	Ø cm
11868	14,5

Kühlakku / cooler / acumulador de frío / accumulateur de froid

	Ø cm	↑ cm
10661	10,5	2,0



Kühlschale Maxi „TOP FRESH“

cool bowl maxi
bol refrigerado MAXI
bol réfrigéré MAXI



4-teilig: 1 Gefäß hochglanzpoliert + 1 Kühlakku + 1 Schale + 1 klappbarer Deckel mit Beschriftungsschild

4 pcs. set: 1 column mirror polished finish + 1 cooler + 1 bowl + 1 cover with card, hinged
set de 4 piezas: 1 base pulido acabado efecto espejo + 1 acumulador de frío + 1 tapa con porta etiqueta + 1 bol

set de 4 pièces : 1 base inox poli brillant + 1 accum. + 1 récipient + 1 couvercle à charnière avec porte-étiquette

	Ø cm	↑ cm	ltr.
11847	22	14	2,5
11849	22	18	4

Ersatzschale / spare bowl / recambio bol / bol de rechange

	Ø cm	↑ cm
11846	22	8
11848	22	12

Schutzdeckel mit Löffelaussparung / cover / tapa / couvercle

	Ø cm
11878	23,5

Kühlakku / cooler / acumulador de frío / accumulateur de froid

	Ø cm	↑ cm
10777	15	2,5



11845
2,5 ltr.

11875

Kühlschale Maxi „TOP FRESH“

cool bowl maxi
cuenco refrigerado MAXI
bol réfrigéré MAXI



4-teilig: 1 Gefäß hochglanzpoliert + 1 Kühlakku + 1 Glasschale + 1 klappbarer Deckel mit Beschriftungsschild

4 pcs. set: 1 column mirror polished finish + 1 cooler + 1 glass bowl + 1 cover with card, hinged

set de 4 piezas: 1 base pulido acabado efecto espejo + 1 acumulador de frío + 1 tapa con porta etiqueta + 1 bol vidrio

set de 4 pièces : 1 base inox poli brillant + 1 accum. + 1 bol verre + 1 couvercle à charnière avec porte-étiquette

	Ø cm	↑ cm	ltr.
11845	23	14	2,5

Schale / bowl / cuenco / bol

	Ø cm	↑ cm	ltr.
11875	23	10,5	2,5

Schutzdeckel mit Löffelaussparung / cover / tapa / couvercle

	Ø cm
11878	23,5

Kühlakku / cooler / acumulador de frío / accumulateur de froid

	Ø cm	↑ cm
10777	15	2,5



kühlt bis zu 3 Stunden

83920
passender Deckel

Kühlschale, 2-teilig „COOL“

cool bowl, 2 pcs. set
cuenco refrigerado, 2 pz.
set de 2 bols réfrigérés



2-teilig, doppelwandig, Schale ist mit Kühlmittel gefüllt und wird zum Aufladen in das Gefrierfach gelegt, endlos verwendbar

2 pcs., 1 pc. double wall ice bowl filled with freezer-liquid, 1 pc. stainless bowl

bol isotérmico, doble pared que contiene un líquido refrigerante, acumula el frío en el congelador para luego mantener fríos los alimentos, para usos repetitivos

bol isotherme, double paroi qui contient un liquide réfrigérant, accumule le froid du congélateur pour ensuite maintenir froids les aliments, pour usages répétés

	Ø cm	↑ cm	ltr.
30023	23	10,5	1

Deckel „FLOAT“ mit Löffelaussparung / cover, with notched for spoons / tapa, con espacio para la cuchara / couvercle, avec encoche pour la louche

	Ø cm	↑ cm
83920	20,5	1,3



Vitrine / Thekenaufsatz

showcase
vitrina de mostrador
vitrine de comptoir



rutschfest, aus einem Teil gefertigt
antislip, monoblock produced
plástico transparente, fabricado en 1 pieza
transparente, plastique monoblock (injecté)

	cm	↑ cm
11888	63,5 x 25	25



Snackpresenter

snackpresenter
dispensador de bocadillos
présentoir à sandwiches



mit Safrille und Griffmulde, passend für Vitrine 11888
with recessed grip, suitable for showcase 11888
asa moldeada, apto para la vitrina 11888
anse moulée, apte pour vitrine 11888

	cm	↑ cm	
11887	29 x 19	6,5	3 Mulden / 3 compartments 3 compartimentos / 3 compartiments
11889	60 x 19	7,5	6 Mulden / 6 compartments 6 compartimentos / 6 compartiments

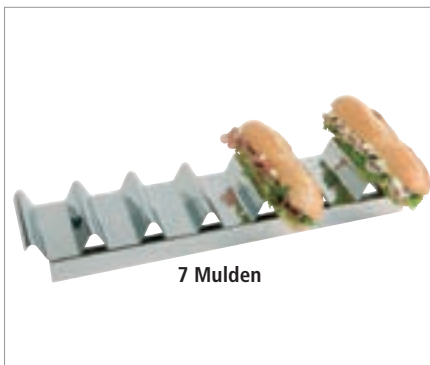

Snackpresenter

snackpresenter
dispensador de bocadillos
présentoir à sandwiches



hochglanzpoliert, mit Griffmulde, für 7 Baguettes
mirror polished finish, with recessed grip, for 7 baguettes
inox pulido brillante, ideal para hasta 7 bocadillos
inox poli brillant, parfait jusque maxi 7 sandwiches

	cm	↑ cm
11891	47,5 x 10,5	6

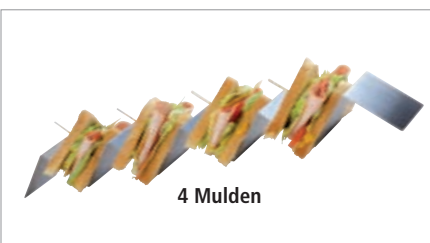

Snackpresenter

snackpresenter
dispensador de bocadillos
présentoir à sandwiches



	cm	↑ cm
11969	56 x 8	5,5

Brotstation



00954
Box

00953
Schneidebrett

83615
Tablett



Tablett „BROTSTATION“

tray
bandeja
plateau



Antirutsch-Füßchen

non-slip feet
pies antideslizantes
pieds antiglisse

cm ↑ cm

83615 59,5 x 35,5 3,5



00953
Schneidebrett

83615
Tablett

Brotschneidebrett „BROTSTATION“

cutting board
tabla de corte
planche à découper



Buchen-Holz

beech
haya
hêtre

cm ↑ cm

00953 52 x 34 2

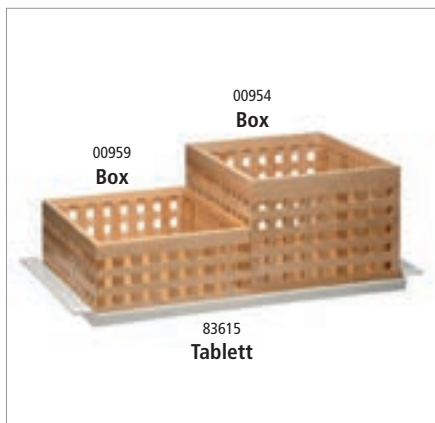

00954
Box

00959
Box

83615
Tablett

Box „BROTSTATION“

box
caja de pan para el bufé
boîte à pain pour le buffet



Buchen-Holz

beech
haya
hêtre

cm ↑ cm

00959 34 x 26 12,5

00954 34 x 26 20,0



Brotschneidebrett „AKAZIA“

cutting board
tabla para cortar
planche à découper



mit herausnehmbarem Krümfach, auf 4 Antirutschfüßchen, Akazienholz
with bread crump shelf, anti slip-feet, wood akazia
tabla para cortar pan, madera tratada antideslizante
planche à pain, bois traité antidérapant

	cm	↑ cm	GN
00883	47,5 x 32,0	2	
00884	53,0 x 32,5	2	1/1
00885	60,0 x 40,0	2	



praktisches Krümfach
praktisches Krümfach



Brotschneidebrett „RUBBERWOOD“

cutting board
tabla para cortar
planche à découper



mit herausnehmbarem Krümfach, auf 4 Antirutschfüßchen
with bread crump shelf, anti slip-feet
tabla para cortar pan, madera tratada antideslizante
planche à pain, bois traité antidérapant

	cm	↑ cm	GN
00955	47,5 x 32,0	2	
00956	53,0 x 32,5	2	1/1
00957	60,0 x 40,0	2	



Brotschneidebrett, 2-tlg.

cutting board, 2 pcs.
tabla para cortar, 2 piezas
planche à découper, 2 pièces



2-tlg. Set, GN 1/1 Behälter, 20 mm tief, dient als Krümfach
2 pcs. set, GN 1/1 pan 20 mm, bread crump shelf
set de 2 piezas: tabla de corte + bandeja inox GN 1/1 alt 20 mm (sirve para recoger las migas)
set de 2 pièces: planche à découper bois + plateau inox GN 1/1 Ht 20 mm (sert de ramasse-miettes)

	cm	GN
00951	53 x 32,5	1/1

einzelnes Brett / separate board / tabla por separado / planche seule

	cm	GN
00952	53 x 32,5	1/1



Brotschneidebrett, 2-tlg.

satin polished finish, cutting board, 2pcs.
tabla para cortar pan, 2 piezas, laterales mates
planche à découper, 2 pièces, bords métal mat



matt poliert, Krümel-Tablett, auf 4 Antirutschfüßchen
crumb tray, anti slip-feet
madera tratada, pies antideslizantes
bois traité, pieds antidérapants

	cm	↑ cm
00950	48 x 32	2



Serviergestell, 2-stufig

serving stand, 2-tier
soporte platos, 2 alturas
présentoir, 2 hauteurs



3 tlg. Set, 1 Gestell aus Akazienholz, 2 Schieferplatten, zusammenklappbar

3 pcs. set, 1 stand acacia wood, 2 slate tray, foldable

set de 3 piezas, 1 soporte madera de acacia, 2 bandeja de pizarra, fácil de plegar

set de 3 pièces, 1 présentoir au pour tous les seaux à FRAMES

	cm	↑ cm
00958	34	36,5 x 26,5



zusammenklappbar
foldable



Hygieneschutz

hygienic cover
cubierta higiénica antialiento
pare-haleine



	cm	↑ cm
11556	82 x 42	45



Brötchenspender

roll dispenser
dispensador de panecillos
distributeur de petits pains



hygienisch und einfach zu reinigen, mit Krümelschale

hygienic and easy to clean, with crumb tray

higiénico y fácil de limpiar, con bandeja para migas

hygiénique et facile à laver, avec plat ramasse-miettes

	cm	↑ cm	
11572	32,5 x 27,5	42	für ca. 45 - 50 Brötchen / for approx. 45 - 50 rolls para 45-50 panecillos / pour 45-50 petits pains
11573	32,5 x 27,5	56	für ca. 65 - 70 Brötchen / for approx. 65 - 70 rolls para 65-70 panecillos / pour 65-70 petits pains

Deckel / Cover / tapa / couvercle seul

	cm	↑ cm
11562	33,5 x 21,5	4



Universalbox

box / sweetbox
caja dispensadora
boîte distributrice



ideal als Verkaufsbox, mit Frontdeckel

best to present sweets etc., all-purpose, with front lid

la perfecta solución para presentar golosinas, universal, con tapa frontal

la solution idéale pour les friandises et autres, universel, avec couvercle frontal

	cm	↑ cm	Farbe / Colour
11884	23 x 14,5	15	White
11885	23 x 14,5	15	Red



NEW

Universalbox
universal box
caja dispensadora
boît distributrice



ideal für Zucker, Milch und Gebäck, 3 Fächer
best for sugar, milk and biscuits, 3 compartments
la perfecta solución para sucre, leche y galletas, 3 compartimentos
la solution idéale pour sucre, lait et biscuits, 3 compartiments

	cm	↑ cm	
11886	41,5 x 20,5	16	



inkl. Löffel

Vorratsdose
canister with spoon
bote con cuchara
pot en verre avec cuillère



Glaskugel mit Löffel, Schraubdeckel mit aromadichtem Verschluss, Edelstahl-Löffel mit magnetischem Silikongriff, 1 Stck.
tight cover, stainless steel spoon with magnetic silicone handle, 1 pc.
acero inoxidable, tapa de vidrio ajustable, cuchara inox con mango magnético, 1pc.
pot en verre avec cuillère avec manche aimanté revêtu de silicone, couvercle à visser pour conserver les arômes, 1 pz.

	Ø cm	↑ cm	ltr.
00636	20	18	3



hot price

Vorratsdose mit Deckel
canister with lid
contenedor con tapa
pot en verre avec couvercle



Glaskugel mit Schraubdeckel, aromadichtem Verschluss, 1 Stck.
glass ball, aroma-tight screw cap, 1 pc.
bola de cristal, tapa de rosca para conservar el aroma, 1 pz.
boule de verre, bouchon à vis de l'arôme étanche, 1 pc.

	cm	↑ cm	ltr.
00637	12,5 x 19	18	1



Glas mit luftdichtem Klappdeckel
glass with airtight cover
cristal, cierre hermético
verre, fermeture hermétique



	cm	↑ cm	ltr.
82328	12 x 12	22	2





Teebox / Multibox

tea caddy
caja para té
boîte à thés et infusions



3 Fächer, aufklappbarer Deckel, mit Löffel

3 chambers, incl. spoon
3 compartimentos, incl. cuchara
3 compartiments, incl. cuillère

	cm	↑ cm
11566	26 x 10	11



Teebox / Multibox

tea caddy
caja para té
boîte à thés et infusions



3 Fächer für kuvertierte Teebeutel, 1 Fach für Zucker, Kekse, etc., Deckel aufklappbar

4 chambers
4 compartimentos
4 compartiments

	cm	↑ cm
11563	22 x 17	9



Teebox

tea-box
caja para té
boîte à thés et infusions



Holzbox mit Sichtfenster, mit Aufschrift „Tee“; 4 Kammern können mit je 30 kuvertierten Teebeuteln bestückt werden, Deckel bleibt offen stehen

wooden box with clear transparent window, with inscription „Tee“, 4 chambers for approx. 30 tea bags

caja de madera clara con ventana transparente, con inscripción „Tee“, 4 compartimentos, para aproximadamente 30 bolsas de té

en bois clair avec fenêtre, marquée „TEE“, 4 compartiments, pour environ 30 sachets

	cm	↑ cm	Farbe / Colour
11575	33,5 x 20	9	
11574	33,5 x 20	9	

	cm	↑ cm	Farbe / Colour
11576	33,5 x 20	9	ohne Aufschrift / without inscription sin inscripción / sans inscription



Teebox

tea-box
caja para té
boîte à thés et infusions



Holzbox mit Sichtfenster, mit Aufschrift „Tee“, 12 Kammern können mit je 12 kuvertierten Teebeuteln bestückt werden, Deckel bleibt offen stehen

wooden box with clear transparent window, with inscription „Tee“, 12 chambers for approx. 144 tea bags

caja de madera clara con ventana transparente, con inscripción „Tee“, 12 compartimentos, para aproximadamente 144 bolsas de té

en bois clair avec fenêtre, marquée „TEE“, 12 compartiments, pour environ 144 sachets

	cm	↑ cm	Farbe / Colour
11775	31 x 28	9	
11776	31 x 28	9	



Besteckständer „TRIPLE TOWER“

cutlery basket
cesta para cubiertos
égouttoir á couverts



4-teiliges Set: 1 Gestell + 3 Köcher
4 pcs. set: 1 frame + 3 baskets
set de 4 piezas: 1 estructura + 3 cubiertos
set de 4 éléments: 1 structure + 3 corbeille

	cm	↑ cm	Farbe / Colour
11466	18 x 26	43	
11467	18 x 26	43	



variable Nutzungsmöglichkeiten
variable usage possibilities



Tisch-Set „VARIO I“

table set
set de mesa
set de table



4-teilig: 1 Ständer + 1 Behälter (innen Ø 7 cm) für Tischreste + 2 Behälter (innen Ø 9 cm) für Besteck, Servietten etc., vielseitig einsetzbar

4 pcs. set: 1 stand + 1 table garbage bin (inner Ø 7 cm) + 2 bins (inner Ø 9 cm) for cutlery, napkins etc., versatile applicable
4 piezas: 1 soporte + 1 papelera Ø 7 cm de sobremesa + 2 recipientes Ø 9 cm para cubiertos, servilletas etc.
4 éléments: 1 support + 1 poubelle de table Ø 7 cm + 2 récipients Ø 9 cm pour couverts, serviettes, etc.

	cm	↑ cm
11925	22 x 22	26

Einzel-Behälter / only container / sólo contenedor / récipient seul

	Ø cm	↑ cm
83998	13 / 7	14
83999	13 / 9	14



Tisch-Set „VARIO II“

table set
set de mesa
set de table



4-teilig: 1 Ständer + 3 Behälter (innen Ø 9 cm) für Besteck, Servietten etc., vielseitig einsetzbar

4 pcs. set: 1 stand + 3 bins (inner Ø 9 cm) for cutlery, napkins etc., versatile applicable
4 piezas: 1 soporte + 3 recipientes Ø 9 cm para cubiertos, servilletas etc.
4 pièces: 1 support, 3 récipients Ø 9 cm, pour couverts, serviettes,...

	cm	↑ cm
11927	22 x 22	26

Einzel-Behälter / only container / sólo contenedor / récipient seul

	Ø cm	↑ cm
83998	13 / 7	14
83999	13 / 9	14



Besteckbehälter „ELEMENT“

cutlery bin
recipiente para cubiertos
récipients pour couverts



mit Abflussloch, mit Besteck Logo, Bodeneinlagen aus Silikon zum Schonen der Messerspitzen , möbelschonende Unterseite
with drain hole, with cutlery logo, silicone floor inserts for saving the points of knives, with non-scratching undersurface
con orificio de drenaje, con logotipo de cubertería, soporte de silicona para proteger las puntas de los cuchillos, con base antirrayaduras
avec le trou de drainage, avec le logo de coutellerie, insert de silicone pour protéger les pointes des couteaux, avec base revêtue antirayures

	Ø cm	↑ cm
00018	11	14



11998
Köcher weiß
PE white

11999
Köcher Edelstahl
stainless steel

Besteckköcher

cutlery basket
cesta para cubiertos
corbeille à couverts



	Ø cm	↑ cm	
11998	9,7	13,7	Kunststoff weiß / white plastic plástico blanco / plastique blanc
11999	9,7	13,7	matt poliert / satin polished finish acero inoxidable / inox



11994

11997

Besteckbehälter

cutlery basket
dispensador de cubiertos
présentoir à couverts



matt poliert
satin polished finish
inox mate (sin cubiertos)
inox mat

	cm	↑ cm	
11994	26,0 x 30 Ø 10	20	4 Löcher inkl. Köcher (Kunststoff) 4 holes incl. dispensers (plastic) 4 agujeros incl. dispensador plástico 4 places, avec 4 récipients (plastique)
11996	26,0 x 30 Ø 10	20	4 Löcher ohne Köcher 4 holes without dispensers 4 agujeros sin dispensador de plástico 4 places, sans récipients
11997	37,5 x 30 Ø 10	20	6 Löcher ohne Köcher 6 holes without dispensers 6 agujeros sin dispensador de plástico 6 places, sans récipients



Besteckbehälter

cutlery basket
recipiente para cubiertos
récipients pour couverts



4 Löcher inkl. 4 Edelstahl Köcher
4 holes incl. 4 stainless baskets
4 agujeros, incl. 4 cestas de acero
4 places, avec 4 corbeille inox

	cm	↑ cm	Farbe / Colour
93321	27 x 27	15	■



GN 1/1 Besteckbehälter

GN 1/1 dispenser GN
GN 1/1 dispensador de cubiertos
GN 1/1 bac à couverts



in Handarbeit geflochten, 4 Mulden, Kunststoff-Geflecht, Drahtgestell, braun-schwarz wickerwork, 4 compartments, with reinforced chromed wire structure, brown-black cesta trensada a mano, 4 compartimentos, de plástico, con bastidor cromado reforzado, marrón oscuro corbeille tressée à main, 4 compartiments, en plastique, cadre acier chromé renforcé, couleur marron foncé

	cm	↑ cm	Farbe / Colour
11966	53 x 32,5	9	



GN 1/1 Besteckbehälter „BUFFET“

GN 1/1 cutlery dispenser
GN 1/1 dispensador de cubiertos
GN 1/1 bac à couverts



4 Mulden, Kunststoff-Geflecht, Drahtgestell, beige
4 troughs, wickerwork, wire, beige
4 huecos, trabajo de cestería
4 compartiments, plastique tressé, cadre acier chromé renforcé, couleur osier naturel

	cm	↑ cm	Farbe / Colour
11965	53 x 32,5	10	



GN 1/1 Besteckbehälter

GN 1/1 cutlery tray / box stand
GN 1/1 dispensador de cubiertos
GN 1/1 bac à couverts



	cm	↑ cm	Farbe / Colour
11955	53 x 32,5	10	
11957	53 x 32,5	10	



GN 1/1 Besteckkasten

cutlery box GN 1/1
GN 1/1 dispensador de cubiertos
GN 1/1 bac à couverts



	cm	↑ cm	Farbe / Colour
11960	53 x 32,5	10	
11962	53 x 32,5	10	





Besteckkorb „ECONOMIC“

cutlery dispenser
dispensador de cubiertos
corbeille à couverts



in Handarbeit geflochten
wickerwork
trensado a mano
tressage à main

	Ø cm	↑ cm	Farbe / Colour
40130	12	15	
40007	12	15	
40012 <small>NEW</small>	12	15	
40013 <small>NEW</small>	12	15	



Besteckkorb „ECONOMIC“

cutlery dispenser
dispensador de cubiertos
corbeille à couverts



in Handarbeit geflochten
wickerwork
trensado a mano
tressage à main

	cm	↑ cm	Farbe / Colour
40131	27 x 10	4,5	
40009	27 x 10	4,5	
40010 <small>NEW</small>	27 x 10	4,5	
40011 <small>NEW</small>	27 x 10	4,5	



Sortierbox „MULTI“

shape sorter
caja surtida
boîte de tri



inklusive 3 herausnehmbare Trennwände, 4 Kammern
including 3 removable divider, 4 chambers
con 3 divisores extraíbles, 4 compartimentos
avec 3 parois de séparation amovibles, 4 compartiments

	cm	↑ cm	ltr.	Farbe / Colour
84531	31,5 x 17,5	7	2,1	
84532	31,5 x 17,5	7	2,1	



Besteckköcher
cutlery basket
cesta para cubiertos
corbeille à couverts



	cm	↑ cm	Farbe / Colour
84535	12 x 12	16	White
84536	12 x 12	16	Black



Abtropflöcher
drainer holes



Besteckständer
cutlery basket
cesta para cubiertos
égouttoir à couverts



matt poliert
satin polished finish
inox mate (sin cubiertos)
inox mat

	Ø cm	↑ cm
11923	12,5	15,5



Besteckständer
cutlery basket
cesta para cubiertos
égouttoir à couverts



	Ø cm	↑ cm
11921	10	10,0
11922	12	13,5



Einzel-Behälter
only container
sólo contenedor
récipient seul



für Besteck, Servietten
for cutlery, napkins
para cubiertos, servilletas
pour couverts ou serviettes, etc

	Ø cm	↑ cm
83999	13 / 9	14



Tischreste- / Besteckbehälter

table garbage bin / cutlery bin
 papelera de sobremesa / recipiente para cubiertos
 poubelle de table / récipients pour couverts



matt poliert, mit abnehmbaren Lochdeckel
 satin polished finish, with removeable cover
 acabado pulido satinado, con tapa desmontable
 poli mat satiné, avec couvercle démontable ouvert au centre

	Ø cm	↑ cm	ltr.
00028	10	12	0,7



Table Caddy „COUNTRY STYLE“

table barrel
 caddy de mesa
 caddy de table



cooler Country-Style, nicht für den direkten Kontakt mit Lebensmittel verwendbar
 make for cool condiment and cutlery holders or even for food presentation, the mini barrels should not come into contact with food, they should be lined with our greaseproof paper
 estilo campo, no aptos para el contacto directo con alimentos, sólo usando papel alimenticio
 de style champêtre, pas de contact direct avec aliments, seulement en utilisant papier alimentaire

	Ø cm	↑ cm
11930	17,5	8,5
11931	11,5	14,0



Tischrestebehälter

table garbage bin
 papelera de sobremesa
 poubelle de table



matt poliert, abnehmbarer Schwingdeckel, mit Bajonettverschluss „fester Deckelsitz“
 satin polished finish, swing cover, cover removable
 acabado satinado, tapa basculante desmontable
 poli mat satiné, couvercle basculant démontable

	Ø cm	↑ cm	ltr.
00029	12	17	1,2
00027	10	13	0,7



Tischrestebehälter

table garbage bin
 papelera de sobremesa
 poubelle de table



matt poliert, abnehmbarer Schwingdeckel, mit Bajonettverschluss „fester Deckelsitz“
 satin polished finish, swing cover, cover removable
 acabado satinado, tapa basculante desmontable
 poli mat satiné, couvercle basculant démontable

	Ø cm	↑ cm	ltr.
00053	14	20	2,0



Tischrestebehälter „SUNDAY“

table waste bin
papelera de sobremesa
poubelle de table



matt poliert, inkl. Deckel, fester Deckelsitz
satin polished finish, incl. cover, cover removeable
acero inoxidable mate, con tapa
inox mat, avec couvercle

	Ø cm	↑ cm	ltr.
00024	10	18	1,1



Tischrestebehälter

table garbage bin
papelera de sobremesa
poubelle de table



Behälter aus weiß lackiertem Metall, Edelstahl-Lochdeckel
metall white, stainless cover with hole
tapa, acero inoxidable, con apertura
couvercle inox, avec ouverture centrale, récipient en acier laqué blanc

	Ø cm	↑ cm	ltr.
00292	12	15	1,2



Tischrestebehälter

table garbage bin
papelera de sobremesa
poubelle de table



Behälter aus weiß lackiertem Metall, abnehmbarer Schwingdeckel
cover stainless steel bin metal, white, swing cover
tapa de acero inoxidable, recipiente chapa lacada blanca
couvercle inox basculant, récipient en acier laqué blanc

	Ø cm	↑ cm	ltr.
00291	12	17	1,2



Tischrestebehälter „INTERNATIONAL“

table waste bin
papelera de sobremesa
poubelle de table



Deckel-Ring mit Dichtung, internationale Beschriftung
cover with sealing ring
tapa con junta, texto multi-idomas
couvercle avec joint, texte multilingue

	Ø cm	↑ cm	ltr.
83847	10	17,5	1



Tischrestebehälter

table garage bin
papelera de sobremesa
poubelle de table



	Ø cm	↑ cm	ltr.	Farbe / Colour
02038	11	14	0,9	
02039 <small>NEW</small>	11	14	0,9	



hot price

Tischrestebehälter
table garbage bin
papelera de sobremesa
poubelle de table



	Ø cm	↑ cm	litr.
00311	14	15	1,2



hot price

Tischrestebehälter
table garbage bin
papelera de sobremesa
poubelle de table



Kunststoff weiß / Granit, abnehmbarer Schwingdeckel
white plastic, swing cover, cover removable
plástico blanco/granito, tapa basculante desmontable
plastique blanc/gris chiné, couvercle basculant démontable

	Ø cm	↑ cm	litr.
00031	12	18	1,4



Tischreste- / Besteckbehälter / Universalbox
table waste bin / cutlery bin / box
papelera de sobremesa / recipiente para cubiertos
poubelle de table / récipients pour couverts



mit verchromten Rand, stapelbar
with chrome plated ring, stackable
con anillo cromado, apilables
avec bord chromé, empilable

	cm	↑ cm	Farbe / Colour
00015	13,5 x 13,5	11	■
00215	13,5 x 13,5	11	■



stapelbar
stackable
apilables
empilable



Tischreste- / Besteckbehälter
table waste bin / cutlery bin
papelera de sobremesa / recipiente para cubiertos
poubelle de table / récipients pour couverts



mit verchromten Rand, inkl. herausnehmbarem Einteiler (4 Fächer)
with chrome plated ring, incl. divider (4 chambers)
con anillo cromado
avec bord chromé

	cm	↑ cm	Farbe / Colour
00016	14 x 14	16	■
00216	14 x 14	16	■



Tischreste- / Besteckbehälter „TOP CHROME“

table waste bin / cutlery bin
 papelera de sobremesa / recipiente para cubiertos
 poubelle de table / récipients pour couverts



mit verchromten Rand
 with chrome plated ring
 con anillo cromado
 avec bord chromé

	Ø cm	↑ cm	litr.	Farbe / Colour
00025	13	15	1	
00026	13	15	1	



Tischreste- / Besteckbehälter „BASE CHROME“

table waste bin / cutlery bin
 papelera de sobremesa / recipiente para cubiertos
 poubelle de table / récipients pour couverts



mit verchromten Boden
 with chrome bottom
 con base cromada
 avec base chromée

	Ø cm	↑ cm	litr.	Farbe / Colour
00019	13	15	1,3	
00020	13	15	1,3	



Tischkrümelentferner

crumber
 recogemigas
 ramasse-miettes



matt poliert, Hohlgriff
 satin polished finish, hollow handles
 acabado mate, fácil de usar, mango hueco
 mat satiné, manche creux, simple à utiliser

	cm	→ cm
00058	6,5 x 2,5	22



Tischkrümelentferner

crumber
 recogemigas
 ramasse-miettes



matt poliert, geschliffene Edelstahlkante lässt kein Körnchen zurück
 satin polished finish, no grain remains thanks to the flat grinded stainless steel edge
 acabado pulido mate, las migas se recogen fácilmente del mantel sin dejar restos gracias a su borde afilado
 mat satiné, ramasse facilement les miettes sur la nappe sans rien laisser grâce au rebord affilé

	cm	↑ cm
00581	19 x 4,5	1



Serviettenhalter „PROFI“
napkin holder, incl. weight
servilletero
porte-serviettes



für 150 Servietten 1/4 Falz, inkl. Beschwerer, mit Antirutschfüßchen, absolut standfest
for 150 napkins 1/4 fold, anti-slip feet, very stable
para 150 servilletas de 1/4 plegado
pour 150 serviettes pliage 1/4

	cm	↑ cm
11766	18,5 x 18,5	18



Serviettenhalter „WIRE“
napkin holder
servilletero
porte-serviettes



für Servietten 1/4 Falz, inkl. Beschwerer
incl. pressure bar, with colour inlay
incluye barrita de contrapeso
barre de contrepoids incluse, acier chromé

	cm	↑ cm	
11763	19 x 19	6,5	für 50 Servietten / for 50 napkins para 50 servilletas / pour 50 serviettes
11765	19 x 19	19	für 150 Servietten / for 150 napkins para 150 servilletas / pour 150 serviettes



Serviettenhalter „BAR“
napkin folder
servilletero
porte-serviettes



für ca. 50 Cocktailservietten, inkl. Beschwerer
for approx. 50 cocktail napkins, incl. weight
para aprox. 50 servilletas de aperitivo, incluye barrita de contrapeso
pour environ 50 serviettes mini, barre de contrepoids incluse

	cm	↑ cm
11762	14 x 14	6,5



Serviettenhalter
napkin holder
servilletero
porte-serviettes



matt poliert
satin polished finish
acabado satinado
mat satiné

	cm	↑ cm
11730	17 x 17	5



Serviettenhalter

napkin holder
servilletero
porte-serviettes



hochglanzpoliert, für Servietten mit 1/8 Falz, Füße mit rutsch- und kratzfester Gummierung
mirror polished finish, for napkins with 1/8 fold, rubber feet
acabado brillante, para servilletas con plegado 1/8
brillant, pour serviettes avec pliage 1/8

	cm	↑ cm
11720	10 x 11,5	18,5



Serviettenhalter

napkin holder
servilletero
porte-serviettes



möbelschonende Unterseite, für ca. 30 Servietten, matt poliert
non-scratching undersurface, for approx. 30 napkins, satin polished finish
pie revestido antiralladuras, para aprox. 30 servilletas, acabado mate
piéd revêtu pour ne pas rayer le mobilier, pour environ 30 serviettes, poli mat satiné

	cm	↑ cm
11780	15 x 4,5	12,5



Serviettenhalter

napkin holder
servilletero
porte-serviettes



möbelschonende Unterseite, für ca. 20 Servietten, matt poliert
non-scratching undersurface, for approx. 20 napkins, satin polished finish
pie revestido antiralladuras, para aprox. 20 servilletas, acabado pulido brillante
piéd revêtu pour ne pas rayer le mobilier, pour environ 20 serviettes, poli mat satiné

	cm	↑ cm
11778	17 x 3	7



Serviettenhalter

napkin holder
servilletero
porte-serviettes



möbelschonende Unterseite, für ca. 20 Servietten, hochglanzpoliert
non-scratching undersurface, for approx. 20 napkins, mirror polished finish
pie revestido antiralladuras, para aprox. 20 servilletas, acabado pulido brillante
piéd revêtu pour ne pas rayer le mobilier, pour environ 20 serviettes, brillant

	cm	↑ cm
11777	17 x 3	7



Isolierkanne „ADVANCED“

vacuum jug
jarra termo
bouteille isotherme

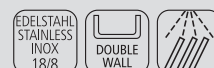

doppelwandig, spülmaschinenfest, Einhandautomatik, aufgeklappt passt die Kanne unter die gängigen Kaffeemaschinen, Höhe mit geöffneter Klappe = 18 cm, für heiße und kalte Getränke

double-walled, dishwasher-safe, easy pouring system, with flipped-back lid, the air pot fits under a wide range of coffee makers, height with flipped-back lid = 18 cm for hot and cold beverages

doble pared, resistente al lavavajillas, se maneja con 1 mano, con la tapa abierta la jarra se puede usar con casi todas las cafeteras corrientes, altura de la jarra con la tapa abierta = 18 cm, para bebidas frías y calientes

double paroi, résistante au lave-vaisselle, usage à 1 main, avec la couvercle ouverte la bouteille se peut user avec toutes les machines à café courantes, hauteur de la bouteille avec couvercle ouverte = 18 cm, pour boissons chaudes ou froides

	Ø cm	↑ cm	ltr.	Anzahl der Tassen
10921	10,5	13	0,3	2,5
10922	10,5	18	0,6	5
10923	13,0	19,5	1,0	8
10924	13,0	23,5	1,5	12



Isolierkanne „CLASSIC“

vacuum jug
jarra termo
bouteille isotherme



doppelwandig, Einhandautomatik, Drehverschluss, für heiße und kalte Getränke

double-walled, easy push-button pouring system, screw cap, for hot and cold drinks

doble pared, se maneja con 1 mano, con tapa a rosca, para bebidas frías y calientes

double paroi, usage à 1 main, couvercle à visser, pour boissons chaudes ou froides

	Ø cm	↑ cm	ltr.	Anzahl der Tassen
10910	14	19	1,0	8
10911	14	22	1,5	12
10912	14	25	2,0	16



Isolierkanne „ECONOMY“

vacuum jug
jarra termo
bouteille isotherme



robuste Umhüllung mit Polypropylen-Kunststoff, Stabilglaseinsatz, Drehverschluss mit Drucktasten-Bedienung für heiße und kalte Getränke, 8 Tassen

double-walled with glass liner, screw cap with easy push-button pouring system, for hot and cold beverages, 8 cups

exterior de plástico polipropileno, interior aislante de vidrio, con tapa a rosca con cierre dosificador para bebidas frías y calientes, 8 tazas

extérieur en plastique polypropylène, intérieur avec plaque de verre, couvercle à visser, pour boissons chaudes ou froides, 8 tasses

	Ø cm	↑ cm	ltr.	Farbe / Colour
10913	16	20	1,0	White
10914	16	20	1,0	Black



Pump-Isolierkanne „PREMIUM“

air pot
jarra termo
bouteille isotherme



doppelwandig, Tragegriff, drehbarer Fuß, Pumpmechanismus und Füllstandsanzeige sind leicht zu reinigen mit 4 unterschiedlichen Inhaltsbeschriftungen für den Pumphebel (coffee, tea, hot water, decaf), aufgeklappt passt die Kanne unter die gängigen Kaffeemaschinen, für heiße und kalte Getränke

double-walled, carrying handle, pivotable feet, pump mechanism and fill level indicator is easily removable for cleaning, includes 4 different beverage signs (coffee, tea, hot water, decaf), with flipped-back lid, the air pot fits under a wide range of coffee makers, for hot and cold beverages

doble pared, con asa al lateral, pié girable, el mecanismo a presión y el indicador óptico del nivel son fáciles de limpiar, con 4 etiquetas diferentes para la palanca (coffee, tea, hot water, decaf), con la tapa abierta la jarra se puede usar con casi todas las cafeteras corrientes, para bebidas frías y calientes

double paroi, avec poignée, pied pivotant, le mécanisme à pression et l'indicateur de niveau sont faciles à retirer pour le nettoyage, avec 4 étiquettes différents pour la pompe (coffee, tea, hot water, decaf), avec la couvercle ouverte la bouteille se peut user avec toutes les machines à café courantes, pour boissons chaudes ou froides

	Ø cm	↑ cm	ltr.	Anzahl der Tassen
10916	15	37,0	3,0	24

Tropfenfänger für Pump-Isolierkanne / drip tray for air pot / recoge gotas para jarra termo / ramasse-gouttes pour bouteilles isotherme

	cm	↑ cm
10917	24,0 x 18,5	4



Pump-Isolierkanne „BUDGET“

air pot
jarra termo
bouteille isotherme



doppelwandig, Tragegriff, Dreh-Pumpknopf zur leichten Bedienung (close/open), Pumpmechanismus ist leicht zu entnehmen und zu reinigen, aufgeklappt passt die Kanne unter die gängigen Kaffeemaschinen, für heiße und kalte Getränke

double-walled, carrying handle, rotatable Push-Button for easy use (close/open), pump mechanism is easily removable for cleaning, with flipped-back lid, the air pot fits under a wide range of coffee makers, for hot and cold beverages

doble pared, con asa al lateral, tapa girable y a presión para uso fácil (close/open), el mecanismo a presión es fácil de retirar para limpiar, con la tapa abierta la jarra se puede usar con casi todas las cafeteras corrientes, para bebidas frías y calientes

double paroi, avec poignée, couvercle à visser et a pression pour facile usage (close/open), le mécanisme à pression est facile à retirer pour le nettoyage, avec la couvercle ouverte la bouteille se peut user avec toutes les machines à café courantes, pour boissons chaudes ou froides

	Ø cm	↑ cm	ltr.	Anzahl der Tassen
10915	13,5	32,5	2,2	17





Buffet & Tabletop Melamin

Buffet & Tabletop
Melamin

Tablets
Schalen
Teller
Fingerfood
Eierbecher

bandejas
cuencos
platos
finger food
huevera

trays
bowls
plates
finger food
egg holder

plateaus
bols
assiettes
finger food
coquetier

HANOI



Die ansteigenden Schalenformen erzeugen eine asiatische Markt Optik und verleihen Ihrem Buffet durch die gewobene Oberflächenstruktur eine natürliche Authentizität. HANOI lässt sich vielseitig in unterschiedlichen Buffet- und Speiserichtungen als Präsentationshilfe für Brot, Gebäck, Obst und Salat einsetzen.

The rising bowl forms create an Asian market look and give your buffet a natural authenticity through the woven surface structure. HANOI can be used in various buffet and dining directions as a presentation aid for bread, pastries, fruit and salads.

La forma creciente de los cuencos crea un look de un mercado asiático y le dá a su bufé una autenticidad natural gracias a la estructura de la superficie tejida. HANOI se puede utilizar en el bufé y el comedor para la presentación de pan, pasteles, fruta y ensaladas.

La forme croissante de bols crée un aspect visuel d'une marché asiatique et donne à votre buffet une authenticité naturelle à travers la structure de surface tissée. HANOI peut être utilisé dans différents buffets et restaurants comme une aide à la présentation pour pain, pâtisseries, fruits et salades.



Schale / Teller „HANOI“

bowl / tray
cuenco / bandeja
bol / plateau



	∅ cm	↑ cm
84725	25,5	3,0 / 6,5
84726	30,0	3,5 / 7,5
84727	35,5	4,0 / 9,0



AQUARIS

NEW

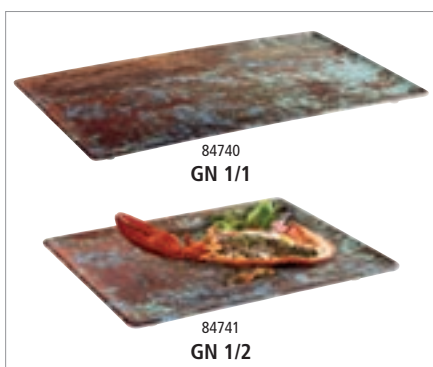

GN Tablett „AQUARIS“

GN tray
GN bandeja
GN plateau



	cm	↑ cm	GN	Farbe / Colour
84740	53,0 x 32,5	2	1/1	
84741	32,5 x 26,5	2	1/2	
84742	32,5 x 17,6	2	1/3	
84743	53,0 x 16,2	2	2/4	

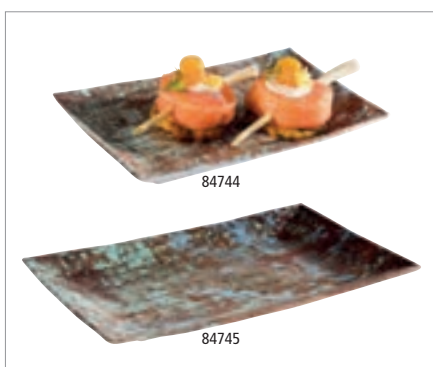

Tablett „AQUARIS“

tray
bandeja
plateau



	cm	↑ cm	Farbe / Colour
84744	21,0 x 13,0	3	
84745	34,5 x 22,0	3	

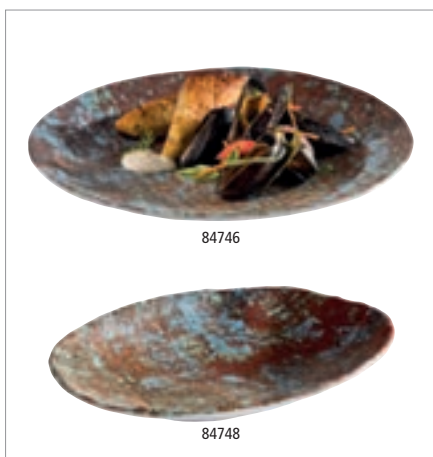

Teller „AQUARIS“

plate
plato
assiette



	Ø cm	↑ cm	Farbe / Colour
84746	26	3,5	
84747	35	3,0	

	cm	↑ cm	Farbe / Colour
84748	24,0 x 17,0	3,5	
84749	40,5 x 30,0	4	

JADE

NEW



Mit der mineralen Optik und dem beeindruckenden Grünton der Jadesteine setzt diese Serie jedes Buffet in Szene und vermittelt ein asiatisches, natürliches Flair. Die Schalen runden das Programm ab und bieten passende Alternativen für das Servieren am Tisch.

With a mineral look and the impressive green tone of the Jadestones, this series puts every buffet in the scene and transmits an Asian, natural flair.

Con una óptica mineral y los tonos verdes impresionantes de jade, esta serie pone cada bufé en escena y transmite un toque asiático y natural.

Avec un look minéral et les impressionnants tons verts des pierres de jade, cette série met chaque buffet en scène et transmet un caractère naturel asiatique.



GN Tablatt „JADE“

GN tray
GN bandeja
GN plateau



	cm	↑ cm	GN
84709	53,0 x 32,5	3	1/1
84710	32,5 x 26,5	3	1/2
84711	32,5 x 17,6	3	1/3
84712	53,0 x 16,2	3	2/4



Tablett / Sushiboard „JADE“

tray / sushiboard
bandeja para sushi
plateau sushi



	cm	↑ cm
84707	22,0 x 9,5	2,0
84708	22,5 x 13,5	3,5



Schale „JADE“

bowl
cuenco
bol



	Ø cm	↑ cm	litr.
84700	10,5	5,0	0,2



Schale „JADE“

bowl
cuenco
bol



	Ø cm	↑ cm	litr.
84701	11,5	4,0	0,15



Schale „JADE“

bowl
cuenco
bol



	Ø cm	↑ cm	litr.
84702	14	4,5	0,25



Schale „JADE“

bowl
cuenco
bol



	Ø cm	↑ cm	litr.
84703	18	6,0	0,55



Schale „JADE“

bowl
cuenco
bol



	Ø cm	↑ cm	litr.
84704	22	7,5	1,2



Schale „JADE“

bowl
cuenco
bol



	cm	↑ cm	litr.
84705	22 x 22	9	1,3
84706	28 x 28	14	2,8

84705

STONE ART



Teller „STONE ART“
plate
plato
assiette



	Ø cm	↑ cm
84510	19,0	2,0
84511	25,0	2,0
84512	30,0	2,0



Teller „STONE ART“
plate
plato
assiette



	Ø cm	↑ cm	litr.
84509	15,5	2,5	0,15
84514	20,0	4,5	0,60



Teller „STONE ART“
plate
plato
assiette



	Ø cm	↑ cm
84515	24,5	3,5



Teller „STONE ART“
plate
plato
assiette



	cm	↑ cm
84517	33,0 x 32,5	3,0



Schale „STONE ART“

bowl
cuenco
bol



	Ø cm	↑ cm	litr.
84523	8,0	3,0	0,07



Schale „STONE ART“

bowl
cuenco
bol



	Ø cm	↑ cm	litr.
84524	12,0	6,0	0,3



Schale „STONE ART“

bowl
cuenco
bol



	Ø cm	↑ cm	litr.
84525	15,0	7,5	0,6



Schale „STONE ART“

bowl
cuenco
bol



	cm	↑ cm	litr.
84526	23,0 x 19,0	6,5	0,6



Schale „STONE ART“

bowl
cuenco
bol



	cm	↑ cm	litr.
84528	28,5 x 21,0	7,5	1,2



Schale „STONE ART“

bowl
cuenco
bol



	cm	↑ cm	litr.
84529	19,0 x 19,0	6,0	0,5
84530	24,0 x 24,0	6,5	1,1

84529

Buffet & Tabletop Melamin



GN Tablett „STONE ART“

GN tray
GN bandeja
GN plateau



	cm	↑ cm	GN
84519	53,0 x 32,5	1,5	1/1
84520	32,5 x 26,5	1,5	1/2
84522	53,0 x 16,2	1,5	2/4
84521	32,5 x 17,6	1,5	1/3



mit Antirutschfüßchen
non-slip feet
con pies antid deslizantes
avec pieds antidérapants



GN Abdeckhaube

GN cover
GN cubierta
GN cloche



passend für GN Tablett, glasklarer Kunststoff, nahezu unzerbrechlich
suitable for GN trays, clear plastic, nearly unbreakable
apto para bandejas GN, plástico transparente, muy resistente a la rotura
pour bacs et plateaux GN, plastique transparent, très résistant à la casse

	cm	↑ cm	GN
11041	32,5 x 26,5	9,5	1/2
11042	53,0 x 32,5	9,5	1/1

ELEMENT

NEW



Betonoberflächen auf dem Buffet für den Kontakt mit Lebensmitteln?

ELEMENT macht es möglich. Die GN-Platten können gekonnt in Szene gesetzt werden und bestechen durch ihre täuschend echte Betonoptik. Bestens geeignet im modernen und urbanen Ausstattungsumfeld.

Concrete surfaces on the buffet for food contact?

ELEMENT makes it possible. The GN trays can be skilfully staged in scene and captivate you with their deceptive real concrete optic. Ideally suited for modern and urban environments.

Superficies de hormigón en el bufé y tener contacto con alimentos?

ELEMENT lo hace posible. Las bandejas GN se pueden poner en escena y cautivarle con su óptica de hormigón. Ideal para ambientes modernos y urbanos.

Des surfaces en béton sur le buffet et destinées au contact alimentaire?

ELEMENT le rend possible. Les plateaux GN peuvent être habilement mis en scène et vous captiver avec leur véritable optique en béton. Idéal pour les environnements modernes et urbains.



GN Tablett „ELEMENT“

GN tray
GN bandeja
GN plateau



	cm	↑ cm	GN
84400	53,0 x 32,5	3,5	1/1
84401	32,5 x 26,5	3,5	1/2
84404	53,0 x 16,2	3,5	2/4
84402	32,5 x 17,5	3,5	1/3
84403	26,5 x 16,2	3,5	1/4

GLAMOUR



Schalen und Tablett in elegant matt-schwarz, mit glänzenden Sprenkeln, „Hingucker“ für Tisch und Buffet.

Bowls and trays in elegant matte black color with glossy spots, an eye-catcher for table and buffet.

Cuencos y bandejas en color negro mate elegante con una superficie brillante con salpicaduras, una atracción para su mesa y bufé.

Bols et plateaux en couleur noir mat élégant avec une surface brillante mouchetée, point de mire pour la table et le buffet.



Schale „GLAMOUR“

bowl
cuenco
bol



	∅ cm	↑ cm	ltr.
84365	8	3	0,05



Schale „GLAMOUR“

bowl
cuenco
bol



	∅ cm	↑ cm	ltr.
84366	12	5	0,35



Schale „GLAMOUR“

bowl
cuenco
bol



	∅ cm	↑ cm	ltr.
84367	15	8	0,70



Schale „GLAMOUR“
bowl
cuenco
bol



	cm	↑ cm	ltr.
84373	19,5 x 9	5	0,2
84374	21,5 x 14,5	4,5	0,3



Tablett „GLAMOUR“
tray
bandeja
plateau



	cm	↑ cm
84375	26,5 x 8,5	2
84376	33,5 x 11	3



Tablett „GLAMOUR“
tray
bandeja
plateau



	cm	↑ cm
84377	22 x 12	3
84378	37 x 11	2,5



Tablett „GLAMOUR“
tray
bandeja
plateau



	cm	↑ cm
84380	25 x 15,5	1,5
84381	30,5 x 19	1,5



Tablett „GLAMOUR“
tray
bandeja
plateau



	cm	↑ cm
84379	30 x 11	3

LAGOON



Servierartikel mit kupferfarbenem Rand. Schlicht und zeitlos. Ideal für den Einsatz im Außenbereich (Pool, Spa, etc.).

Serving items with copper-colored border. Simple and timeless. Ideal for outdoor use (pool, spa, etc.).

Artículos de servicio con borde de color cobre. Simple e intemporal. Ideal para uso al aire libre (piscina, spa, etc.).

Pièces de service avec bord couleur cuivre. Simple et intemporel. Idéal pour une utilisation à l'extérieur (piscine, spa, etc.).



Teller „LAGOON“

plate
plato
assiette



	∅ cm	↑ cm	
84540	20,0	2,5	flacher Teller / flat plate
84541	22,5	2,5	flacher Teller / flat plate



Teller „LAGOON“

plate
plato
assiette



	∅ cm	↑ cm	
84543	22,5	3,0	tiefer Teller / deep plate
84542	28,0	3,0	tiefer Teller / deep plate



Teller „LAGOON“

plate
plato
assiette



	cm	↑ cm	
84544	24 x 24	2,5	



84546

Tablett „LAGOON“

tray
bandeja
plateau



	cm	↑ cm	
84545	21,5 x 14,5	2	
84546	24,5 x 16,5	2	



Schale „LAGOON“

bowl
cuenco
bol



	Ø cm	↑ cm	litr.
84551	9,5	4,5	0,1



Schale „LAGOON“

bowl
cuenco
bol



	cm	↑ cm	litr.
84552	14,5 x 14,5	7,0	0,6



84554

83601

83600

Schale „LAGOON“

bowl
cuenco
bol



	cm	↑ cm	litr.
84553	19 x 19	9	1,5
84554	25 x 25	12	3,8

Deckel „PURE“ mit Löffelaussparung / cover with notched for spoons / tapa con espacio para la cuchara / couvercle avec encoche pour la louche

	cm	↑ cm	fits to
83600	19 x 19	1,5	84553
83601	25 x 25	1,5	84554



Tasse / Untertasse „LAGOON“

cup / saucer
taza / platillo
tasse / soucoup



	Ø cm	↑ cm	litr.	
84549	14	2		Kaffeuntertasse / saucer
84550	8	6	0,17	Kaffeetasse / cup

CROCKER



Servier- und Buffetartikel in Tonoptik, brauner Rand. Die Oberfläche ist innen und außen fein-matt, fühlt sich an wie Ton.

Serving and buffet items, an imitation of clay, with a brown border. The surface is inside and outside fine-matt. Feels like real clay.

Artículos de servicio y bufé, imitación barro y con borde marrón. La superficie de dentro y de fuera es de deslustre fino. Parece barro natural.

Pièces de service et pour le buffet imitation argile avec bord marron. La surface est à l'intérieur et à l'extérieur bien-matte.



Teller „CROCKER“

plate
plato
assiette



	cm	↑ cm	Farbe / Colour
84567	14 x 13	2,5	
84568	14 x 13	2,5	



Teller „CROCKER“

plate
plato
assiette



	Ø cm	↑ cm	ltr.	Farbe / Colour
84575	20,5	3	0,50	
84576	20,5	3	0,50	



Schale „CROCKER“

bowl
cuenco
bol



	Ø cm	↑ cm	ltr.	Farbe / Colour
84573	16,5	4	0,50	
84574	16,5	4	0,50	



84569
Ø 12,5 cm

84572
Ø 16,0 cm

84577
Ø 21,0 cm

Schale „CROCKER“

bowl
cuenco
bol



	Ø cm	↑ cm	ltr.	Farbe / Colour
84569	12,5	6	0,37	
84570	12,5	6	0,37	
84571	16,0	7	0,70	
84572	16,0	7	0,70	
84577	21,0	8	1,45	
84578	21,0	8	1,45	



84579

84581

Blattschale „CROCKER“

leaf
fuente en forma de hoja
plateau feuille



	cm	↑ cm	ltr.	Farbe / Colour
84579	30,5 x 10,0	7,5	0,17	
84580	30,5 x 10,0	7,5	0,17	
84581	42,0 x 14,0	9,5	0,65	
84582	42,0 x 14,0	9,5	0,65	

FRIDA

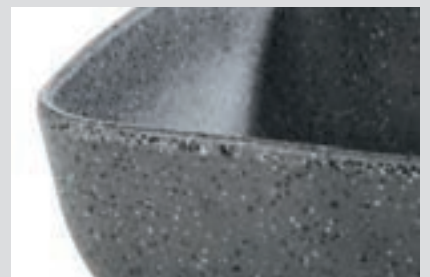

Einfache und klare Form-
sprache - nordeuropäisches
Design, innen und außen ist
die Oberfläche matt, innen
Holzoptik, außen uni-far-
ben.

Simple and clear design -
scandinavian design, the
surface inside and outside
is matt, interior is wooden
finish, outside is plain
colored.

Estilo sencillo y claro -
diseño escandinavo, la
superficie de dentro y de
fuera es mate, el interior
imitación madera y el exterior
de un solo color.

Style simple et clair -
conception scandinave, la sur-
face est pâle à l'intérieur
et à l'extérieur, l'intérieur
imitation bois, l'extérieur
de couleur unie.



GN 2/4 Schale „FRIDA“

GN 2/4 bowl
GN 2/4 cuenco
GN 2/4 bol



	cm	↑ cm	GN	ltr.	Farbe / Colour
84564	53,0 x 16,2	7,5	2/4	3,65	White
84565	53,0 x 16,2	7,5	2/4	3,65	Dark Blue/Black



GN 1/9 Schale „FRIDA“

GN 1/9 bowl
GN 1/9 cuenco
GN 1/9 bol



	cm	↑ cm	GN	ltr.	Farbe / Colour
84555	17,6 x 10,8	5,5	1/9	0,5	
84556	17,6 x 10,8	5,5	1/9	0,5	



GN 1/6 Schale „FRIDA“

GN 1/6 bowl
GN 1/6 cuenco
GN 1/6 bol



	cm	↑ cm	GN	ltr.	Farbe / Colour
84583	17,6 x 16,2	7,5	1/6	1,0	
84584	17,6 x 16,2	7,5	1/6	1,0	

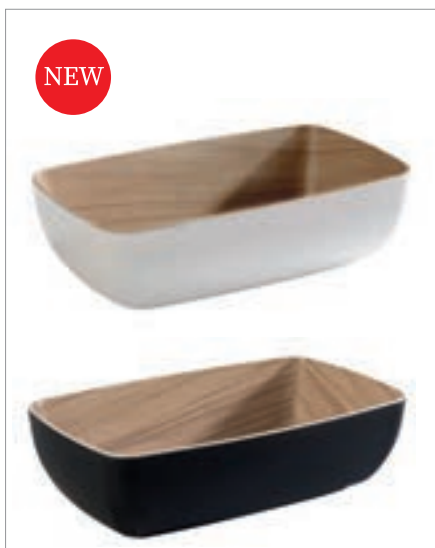

GN 1/4 Schale „FRIDA“

GN 1/4 bowl
GN 1/4 cuenco
GN 1/4 bol



	cm	↑ cm	GN	ltr.	Farbe / Colour
84586	26,5 x 16,2	7,5	1/4	1,8	
84587	26,5 x 16,2	7,5	1/4	1,8	



GN 1/2 Schale

GN 1/2 bowl
GN 1/2 cuenco
GN 1/2 bol



	cm	↑ cm	GN	ltr.	Farbe / Colour
84589	32,5 x 26,5	7,5	1/2	4,0	
84590	32,5 x 26,5	7,5	1/2	4,0	

Buffet & Tabletop Melamin



Schale „FRIDA“

bowl
cuenco
bol



	cm	↑ cm	ltr.	Farbe / Colour
84558	16,5 x 16,5	5,5	0,85	White / Yellow
84559	16,5 x 16,5	5,5	0,85	Black / Yellow



Schale „FRIDA“

bowl
cuenco
bol



	cm	↑ cm	ltr.	Farbe / Colour
84561	25,0 x 25,0	7,5	2,65	White / Yellow
84562	25,0 x 25,0	7,5	2,65	Black / Yellow



GN 1/4 Tablett „FRIDA“

GN tray
GN bandeja
GN plateau



	cm	↑ cm	GN	Farbe / Colour
84595	26,5 x 16,2	3	1/4	White / Yellow
84596	26,5 x 16,2	3	1/4	Black / Yellow

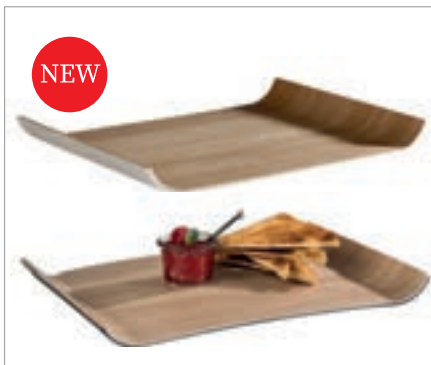

Tablett „FRIDA“

tray
bandeja
plateau



	cm	↑ cm	Farbe / Colour
84598	35,5 x 26,0	3	White / Yellow
84599	35,5 x 26,0	3	Black / Yellow

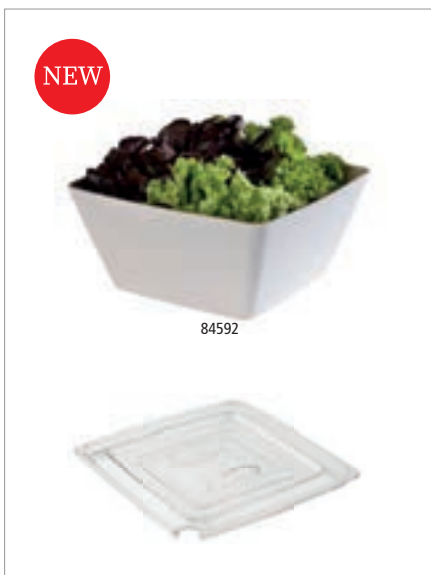

Schale „FRIDA“

bowl
cuenco
bol



	cm	↑ cm	ltr.	Farbe / Colour
84592	25,0 x 25,0	12,0	3,5	White / Yellow
84593	25,0 x 25,0	12,0	3,5	Black / Yellow

Deckel „PURE“ mit Löffelaussparung / cover with notched for spoons / tapa con espacio para la cuchara / couvercle avec encoche pour la louche

	cm	↑ cm	fits to
83601	25 x 25	1,5	84561, 84562, 84592, 84593, 84594



Schale „FRIDA STONE“

bowl
cuenco
bol



	cm	↑ cm	ltr.	Farbe / Colour
84560	16,5 x 16,5	5,5	0,85	■



Schale „FRIDA STONE“

bowl
cuenco
bol



	cm	↑ cm	ltr.	Farbe / Colour
84563	25,0 x 25,0	7,5	2,65	■



GN 1/4 Tablett „FRIDA STONE“

GN 1/4 tray
GN 1/4 bandeja
GN 1/4 plateau



	cm	↑ cm	GN	Farbe / Colour
84597	26,5 x 16,2	3	1/4	■



Tablett „FRIDA STONE“

tray
bandeja
plateau



	cm	↑ cm	Farbe / Colour
84600	35,5 x 26,0	3	■



Schale „FRIDA STONE“

bowl
cuenco
bol



	cm	↑ cm	ltr.	Farbe / Colour
84594	25,0 x 25,0	12,0	3,5	■

Deckel „PURE“ mit Löffelaussparung / cover with notched for spoons / tapa con espacio para la cuchara / couvercle avec encoche pour la louche

	cm	↑ cm	fits to
83601	25 x 25	1,5	84561, 84562, 84592, 84593, 84594

Buffet & Tabletop Melamin



GN 1/9 Schale „FRIDA STONE“

GN 1/9 bowl
GN 1/9 cuenco
GN 1/9 bol



	cm	↑ cm	GN	litr.	Farbe / Colour
84557	17,6 x 10,8	5,5	1/9	0,5	■



GN 1/6 Schale „FRIDA STONE“

GN 1/9 bowl
GN 1/9 cuenco
GN 1/9 bol



	cm	↑ cm	GN	litr.	Farbe / Colour
84585	17,6 x 16,2	7,5	1/6	1,0	■



GN 1/4 Schale

GN 1/4 bowl
GN 1/4 cuenco
GN 1/4 bol



	cm	↑ cm	GN	litr.	Farbe / Colour
84588	26,5 x 16,2	7,5	1/4	1,8	■



GN 1/2 Schale „FRIDA STONE“

GN 1/2 bowl
GN 1/2 cuenco
GN 1/2 bol



	cm	↑ cm	GN	litr.	Farbe / Colour
84591	32,5 x 26,5	7,5	1/2	4,0	■



GN 2/4 Schale „FRIDA STONE“

GN 2/4 bowl
GN 2/4 cuenco
GN 2/4 bol



	cm	↑ cm	GN	litr.	Farbe / Colour
84566	53,0 x 16,2	7,5	2/4	3,65	■

FLOWER POT



Buffet & Tabletop
Melamin



Schale „FLOWER POT“

bowl
cuenco
bol



	Ø cm	↑ cm	ltr.	Farbe / Colour
84470	6	3,5	0,04	White
84471	6	3,5	0,04	Orange
84472	6	3,5	0,04	Grey
84473	9	8,5	0,30	White
84474	9	8,5	0,30	Orange
84475	9	8,5	0,30	Grey
84476	12	3,5	0,20	White
84477	12	3,5	0,20	Orange
84478	12	3,5	0,20	Grey
84479	13	15	1,00	White
84480	13	15	1,00	Orange
84481	13	15	1,00	Grey
84482	20	9	1,80	White
84483	20	9	1,80	Orange
84484	20	9	1,80	Grey

Deckel „UNIVERSAL“ mit Löffelaussparung / cover with notched for spoons
tapa con espacio para la cuchara / couvercle avec encoche pour la cuillère

	Ø cm	↑ cm	fits to
15341	20	1,5	84482, 84483, 84484

TIMBER



Die Melaminplatten (Holzoptik Fichte) haben eine leichte Struktur und wirken optisch wie aus Holz gefertigt.

Superb spruce wood effect (timber), cutting edge gourmet presentation idea, never produce mould or sawdust, clean and hygienic, no more worries about crack.

Melamina imitación madera de picea, para recetas auténticas.

Mélamine imitation spruce, pour vos recettes authentiques.



Tablett „TIMBER“

tray
bandeja
plateau



	Ø cm	↑ cm
84266	35	3
84267	44	3



Tablett „TIMBER“

tray
bandeja
plateau



	cm	↑ cm
84268	44 x 25	1,5



Tablett „TIMBER“

tray
bandeja
plateau



	cm	↑ cm
84269	65 x 26	3



Tablett „TIMBER“

tray
bandeja
plateau



	cm	↑ cm
84256	70 x 26	3

OAK



Die Melaminplatte (Holzoptik Eiche) haben eine leichte Struktur und wirken optisch wie aus Holz gefertigt.

Superb oak wood effect, cutting edge gourmet presentation idea, never produce mould or sawdust, clean and hygienic, no more worries about crack.

Melamina imitación madera de roble, para recetas auténticas.

Mélamine imitation chêne, pour vos recettes authentiques.



Tablett „OAK“

tray
bandeja
plateau



	∅ cm	↑ cm	→ cm
84177	30	1,5	Griff / handle 12



Tablett „OAK“

tray
bandeja
plateau



	cm	↑ cm	→ cm
84178	40,0 x 20,0	1,5	Griff / handle 13



Tablett „OAK“

tray
bandeja
plateau



	cm	↑ cm	→ cm
84179	48,0 x 20,0	1,5	Griff / handle 13



OAK



OAK bietet Ihnen neben den Buffetplatten im Gastrommaß eine ergänzende Auswahl an Serviergrößen für den gedeckten Tisch oder das Catering. Die Serie überzeugt durch die dunkle Eichenholzoptik mit einer holzähnlichen Oberflächenstrukturierung. Im Gegensatz zu richtigem Holz grenzt sich Melamin hier durch einwandfreie, hygienische Verwendung ab.

In addition to the buffet plates in the gastronorm size OAK offers you a complementary selection of serving sizes for the table or catering. The series convinces by the dark oak wood look with a wood-like surface structuring. In contrast to proper wood, melamine is distinguished by flawless hygienic use.

Además de las bandejas de bufé en medida gastronorm OAK le ofrece una selección adicional en tamaños para servir en la mesa o el catering. La serie convence por el look oscuro de la madera del roble y con la estructura superficial de madera. En contraste con la madera auténtica, la melamina se distingue por un uso higiénico impecable.

En plus des plateaux de buffet en taille gastronorm OAK vous offre une sélection complémentaire de dimensions pour servir à table ou la restauration. La série convainc par l'aspect de bois de chêne foncé avec une structure de surface semblable au bois. Contrairement au bois véritable, la mélamine se distingue par une utilisation hygiénique impeccable.



Tablett „OAK“
tray
bandeja
plateau



	cm	↑ cm	→ cm
84431	17,5 x 14,5	1,5	Griff / handle 6,5



Tablett „OAK“
tray
bandeja
plateau



	cm	↑ cm	→ cm
84432	22,0 x 12,0	2,0	Griff / handle 11,0



Tablett „OAK“

tray
bandeja
plateau



	cm	↑ cm
84433	20,0 x 20,0	2,5



Schale „OAK“

bowl
cuenco
bol



	cm	↑ cm
84434	11,5 x 7,0	2,5



Schale „OAK“

bowl
cuenco
bol



	cm	↑ cm
84435	25,0 x 6,5	3,5



GN Tablett „OAK“

GN tray
GN bandeja
GN plateau



Eichenoptik
oak wood effect
imitación madera de roble
imitation chêne

	cm	↑ cm	GN
84720	53,0 x 32,5	1	1/1
84721	32,5 x 26,5	1	1/2
84722	32,5 x 17,6	1	1/3
84723	26,5 x 16,2	1	1/4
84724	53,0 x 16,2	1	2/4

GN 1/1	GN 1/2	GN 1/4	GN 2/4
	GN 1/2	GN 1/4	
GN 1/3	GN 1/3	GN 1/3	

OAK LIGHT



Die Melaminplatten (Holz-optik Eiche hell) haben eine leichte Struktur und wirken optisch wie aus Holz gefertigt.

Superb spruce wood effect (oak light), cutting edge gourmet presentation idea, never produce mould or sawdust, clean and hygienic, no more worries about crack.

Melamina imitación madera de picea, para recetas auténticas.

Mélamine imitation spruce, pour vos recettes authentiques.

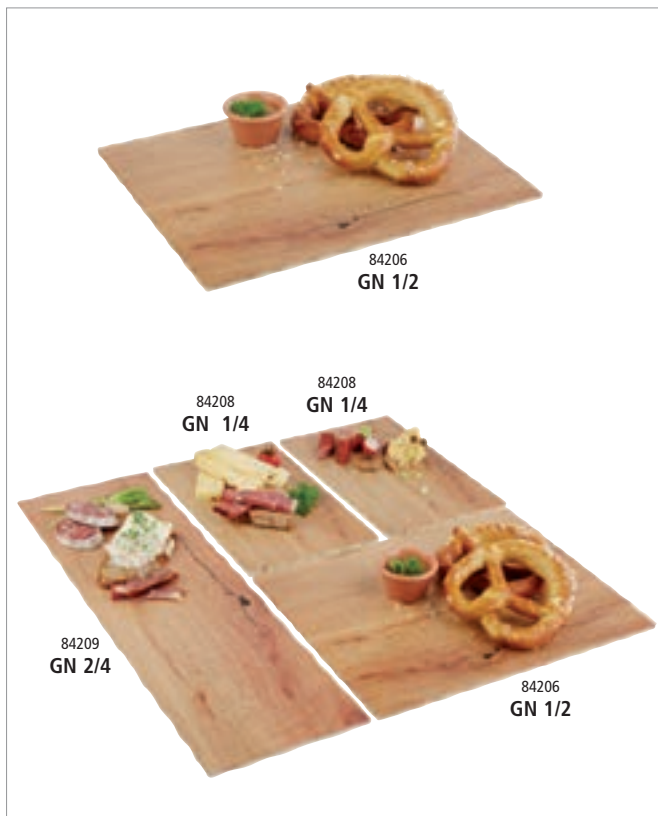

GN Tablett „OAK LIGHT“
tray
bandeja
plateau



	cm	↑ cm	GN
84205	53,0 x 32,5	1,5	1/1
84206	32,5 x 26,5	1,5	1/2
84207	32,5 x 17,6	1,5	1/3
84208	26,5 x 16,2	1,5	1/4
84209	53,0 x 16,2	1,5	2/4

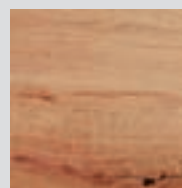

mit Antirutschfüßchen
non-slip feet
con pies antideslizantes
avec pieds antidérapants



Tablett „OAK LIGHT“

tray
bandeja
plateau



	Ø cm	↑ cm
84262	35	3
84263	44	3



Tablett „OAK LIGHT“

tray
bandeja
plateau



	cm	↑ cm
84264	44 x 25	1,5



Tablett „OAK LIGHT“

tray
bandeja
plateau



	cm	↑ cm
84265	65 x 26	3



Tablett „OAK LIGHT“

tray
bandeja
plateau



	cm	↑ cm
84255	70 x 26	3

Buffet & Tabletop Melamin



NEW

GN Tablett „ROCKFACE“

GN tray
GN bandeja
GN plateau



die Melaminplatten (Steinoptik) haben eine leicht wellige Oberfläche und wirken optisch wie ein Naturstein
fantastic imitation of stone

las bandejas de melamina (imitación piedra) tienen una superficie irregular y una óptica semejante a una piedra natural
les plateaux en mélamine (imitation pierre) ont une surface irrégulière que renforce l'aspect de la pierre naturelle

	cm	↑ cm	GN
84770	53,0 x 32,5	1,5	1/1
84771	32,5 x 26,5	1,5	1/2
84772	32,5 x 17,6	1,5	1/3
84773	26,5 x 16,2	1,5	1/4
84774	53,0 x 16,2	1,5	2/4

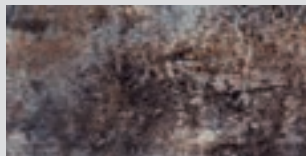

1:1 Oberflächenansicht

1:1 structural view



GN Tablett „MARBLE“

GN tray
GN bandeja
GN plateau



Marmor-Look, glatte und hochglänzende Oberfläche

marble-look, smooth and shiny surface

look mármol, superficie lisa con acabado brillante

look de marbre, surface lisse et finition brillante

	cm	↑ cm	GN
84360	53,0 x 32,5	1,5	1/1
84361	32,5 x 26,5	1,5	1/2
84362	32,5 x 17,6	1,5	1/3
84363	26,5 x 16,2	1,5	1/4
84364	53,0 x 16,2	1,5	2/4



1:1 Oberflächenansicht

1:1 structural view



GN Tablett „ZERO“

GN tray
GN bandeja
GN plateau



glatte, hochglänzende Oberfläche
smooth and shiny surface
superficie lisa con acabado brillante
surface lisse et finition brillante

	cm	↑ cm	GN	Farbe / Colour
84185	53,0 x 32,5	1,5	1/1	
84186	32,5 x 26,5	1,5	1/2	
84187	32,5 x 17,6	1,5	1/3	
84188	26,5 x 16,2	1,5	1/4	
84189	53,0 x 16,2	1,5	2/4	
84195	53,0 x 32,5	1,5	1/1	
84196	32,5 x 26,5	1,5	1/2	
84197	32,5 x 17,6	1,5	1/3	
84198	26,5 x 16,2	1,5	1/4	
84199	53,0 x 16,2	1,5	2/4	



GN Tablett „DRIFTWOOD“

GN tray
GN bandeja
GN plateau

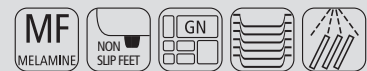

die Melaminplatten (Holzoptik) haben eine leicht wellige Oberfläche und wirken optisch wie aus Holz gefertigt
imagine the durability of melamine and the beauty of wood - fantastic imitation of wood
melamina imitación madera: madera con la durabilidad de la melamina gracias a la superficie ligeramente irregular de la melamina.
mélamine imitation bois: toute bois mais avec la durabilité de la mélamine, la surface irrégulière renforce l'aspect naturel

	cm	↑ cm	GN
84180	53,0 x 32,5	1,5	1/1
84181	32,5 x 26,5	1,5	1/2
84182	32,5 x 17,6	1,5	1/3
84183	26,5 x 16,2	1,5	1/4
84184	53,0 x 16,2	1,5	2/4

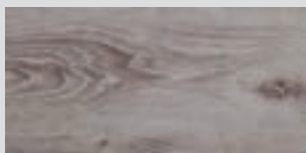

1:1 Oberflächenansicht
1:1 structural view

SLATE



Die schwarzen Melaminplatten überzeugen mit ihrem edlen und schlichten Schieferlook und einer rauhen Oberfläche.

Fantastic imitation of slate. This plates add a rustic feel to your display. Perfect presentation for cluse, chocolates, pastry and meat.

Las bandejas de melamina negras ofrecen un aspecto de pizarra elegante y discreto.

Les plats en mélamine noire offrent l'aspect de l'ardoise, élégants et discrets.



Tablett „SLATE“
tray
bandeja
plateau



	∅ cm	↑ cm
83992	30	1
83994	40	1



GN Tablett „SLATE“

GN tray
GN bandeja
GN plateau



	cm	↑ cm	GN
83981	53,0 x 32,5	1,5	1/1



Schieferoptik
slate look



83955
GN 1/1

GN Tablett „SLATE“

GN tray
GN bandeja
GN plateau



	cm	↑ cm	GN
83955	53,0 x 32,5	1	1/1
83956	32,5 x 26,5	1	1/2
83957	32,5 x 17,6	1	1/3
83958	26,5 x 16,2	1	1/4
83971	53,0 x 16,2	1	2/4



4 cm

GN Tablett „SLATE“

GN tray
GN bandeja
GN plateau



massive Metallgriffe verchromt inkl. fest verschraubten 4 cm Distanzstücken
chrome plated handles, incl. mounted 4 cm distance pillars
asas cromadas, incluye distanciadores a 4 cm
poignées chromées, distance approx. 4 cm

	cm	↑ cm	GN
83980	53,0 x 32,5	6	1/1



84245

83601

83600

Schale „SLATE“

bowl
cuenco
bol



	cm	↑ cm	litr.
84244	19,0 x 19,0	9	1,5
84245	25,0 x 25,0	12	3,8

Deckel „PURE“ mit Löffelaussparung / cover with notched for spoons

tapa con espacio para la cuchara / couvercle avec encoche pour la louche

	cm	↑ cm	fits to
83600	19 x 19	1,5	84244
83601	25 x 25	1,5	84245

Buffet & Tabletop Melamin



Tablett „SLATE“

tray
bandeja
plateau



	Ø cm	↑ cm	→ cm	
84240	18,5	1,5	8,5	Ø Loch 1,5 cm
84241	23,0	1,5	10	Ø Loch 2 cm
84242	33,5	1,5	14	Ø Loch 2,5 cm
84243	37,0	1,5	15,5	Ø Loch 3 cm

Frischhalte-Haube / cover / campana / cloche bombée

	Ø cm	↑ cm	fits to
15350	16,5	10	84240
15351	20,5	10	84241



Tablett „SLATE-ROCK“

tray
bandeja
plateau



Die schwarzen Melaminplatten überzeugen mit ihrem edlen Schieferlook.

Fantastic imitation of slate. This plates add a rustic feel to your display. Perfect presentation for cheese, chocolates, pastry and meat.

Las bandejas de melamina negras ofrecen un aspecto de pizarra elegante y discreto.

Les plats en mélamine noire offrent l'aspect de l'ardoise, élégants et discrets.

	cm	↑ cm
84246	20 x 10	2
84247	30 x 10	2
84248	30 x 15	2

SLATE ROCK



Buffet & Tabletop
Melamin



Tablett „SLATE-ROCK“

tray
bandeja
plateau



Die schwarzen Melaminplatten überzeugen mit ihrem edlen Schieferlook.
Fantastic imitation of slate. This plates add a rustic feel to your display. Perfect presentation for cheese, chocolates, pastry and meat.
Las bandejas de melamina negras ofrecen un aspecto de pizarra elegante y discreto.
Les plats en mélamine noire offrent l'aspect de l'ardoise, élégants et discrets.

	∅ cm	↑ cm	→ cm
84257	30	1,5	Griff 12
	cm	↑ cm	→ cm
84258	40 x 20	1,5	Griff 13
84259	48 x 20	1,5	Griff 13

TIERRA



Schale „TIERRA“

bowl
cuenco
bol



	Ø cm	↑ cm	ltr.	Farbe / Colour
84290	10	7	0,13	
84295	10	7	0,13	



Teller „TIERRA“

plate
plato
assiette



	Ø cm	↑ cm	ltr.	Farbe / Colour
84291	13,5	3	0,13	
84296	13,5	3	0,13	



Schale „TIERRA“

bowl
cuenco
bol



	cm	↑ cm	ltr.	Farbe / Colour
84293	17,0 x 8,5	4	0,2	
84298	17,0 x 8,5	4	0,2	



Tablett „TIERRA“

tray
bandeja
plateau



	cm	↑ cm	GN	Farbe / Colour
84272	53,0 x 16,2	2,5	2/4	
84282	53,0 x 16,2	2,5	2/4	



84283

Schale „TIERRA“

bowl
cuenco
bol



	cm	↑ cm	ltr.	Farbe / Colour
84273	19 x 19	8	1	
84274	25 x 25	10	2,5	
84283	19 x 19	8	1	
84284	25 x 25	10	2,5	



Teller „TIERRA“

plate
plato
assiette



	Ø cm	↑ cm	Farbe / Colour
84276	32,0	3,5	
84286	32,0	3,5	

AIKO



Tablett / Teller „AIKO“

plate / tray
plato / bandeja
assiette / plateau



Steinoptik

appearance stoneware
su aspecto recuerda al gres
l'aspect de la mélamine rapelle le grès

	cm	↑ cm	Farbe / Colour
84324	33 x 25	2,5	White
84325	33 x 25	2,5	Black



Schale „AIKO“

bowl
cuenco
bol



Steinoptik

appearance stoneware
su aspecto recuerda al gres
l'aspect de la mélamine rapelle le grès

	cm	↑ cm	ltr.	Farbe / Colour
84326	26,5 x 19,5	6	0,9	White
84327	26,5 x 19,5	6	0,9	Black



84328

84331

Schale „AIKO“

bowl
cuenco
bol



Steinoptik

appearance stoneware
su aspecto recuerda al gres
l'aspect de la mélamine rapelle le grès

	Ø cm	↑ cm	ltr.	Farbe / Colour
84328	8	4	0,07	White
84330	11,5	6	0,2	White

	Ø cm	↑ cm	ltr.	Farbe / Colour
84329	8	4	0,07	Black
84331	11,5	6	0,2	Black



84334

84337

Schale „AIKO“

bowl
cuenco
bol



Steinoptik

appearance stoneware
su aspecto recuerda al gres
l'aspect de la mélamine rapelle le grès

	Ø cm	↑ cm	ltr.	Farbe / Colour
84334	16	7	0,6	White
84336	20,5	8	1,2	White

	Ø cm	↑ cm	ltr.	Farbe / Colour
84335	16	7	0,6	Black
84337	20,5	8	1,2	Black

LA VIDA



Tablett „LA VIDA“

plate / tray
plato / bandeja
assiette / plateau



	Ø cm	↑ cm	Farbe / Colour
84165	32,0	3,5	
84168	40,5	5,5	
	Ø cm	↑ cm	Farbe / Colour
84161	32,0	3,5	
84170	40,5	5,5	
	Ø cm	↑ cm	Farbe / Colour
84171	32,0	3,5	
84172	40,5	5,5	

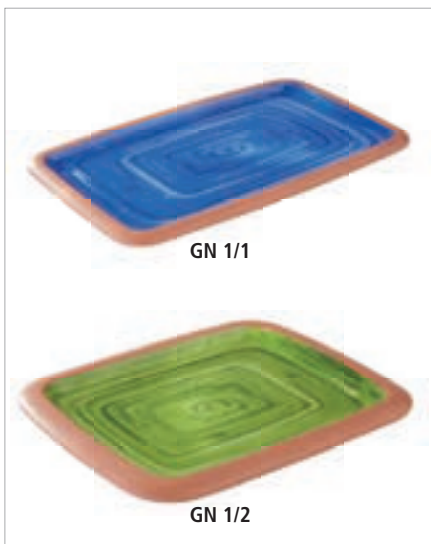

GN Tablett „LA VIDA“

GN tray
GN bandeja
GN plateau



	cm	↑ cm	GN	Farbe / Colour
84144	53,0 x 32,5	2,5	1/1	
84145	32,5 x 26,5	2,5	1/2	
84146	53,0 x 16,2	2,5	2/4	
	cm	↑ cm	GN	Farbe / Colour
84147	53,0 x 32,5	2,5	1/1	
84148	32,5 x 26,5	2,5	1/2	
84149	53,0 x 16,2	2,5	2/4	

MARONE



Eine derbe Oberflächenstruktur schafft ein natürliches Erscheinungsbild.

Die schwarzen Schalenvarianten mit braunem Rand inszenieren Ihr Gericht sehr stilvoll.

A rough surface structure creates a natural appearance. The black bowls and trays with brown border stage your dishes in a very stylish way.

La estructura rugosa de la superficie crea una apariencia natural. Los diferentes cuencos negros con borde marrón ponen con mucho estilo en escena sus platos.

La structure de surface rugueuse crée une apparence naturelle. Les différents bols noirs avec rebord marron mettent élégamment en scène vos plats.



Blattschale „MARONE“

leaf
fuente en forma de hoja
plateau feuille



	cm	↑ cm	ltr.
84100	25,5 x 14	5,5	0,4
84101	36 x 19	8	0,9



Tablett „MARONE“

tray
bandeja
plateau



	cm	↑ cm
84104	22,5 x 15	3
84105	27,5 x 11	2



Tablett „MARONE“

tray
bandeja
plateau



	cm	↑ cm
84103	14,5 x 14,5	2



Tablett „MARONE“

tray
bandeja
plateau



	cm	↑ cm
84106	26,5 x 16,5	4

Buffet & Tabletop Melamin



Schale „MARONE“

bowl
cuenco
bol



	cm	↑ cm	ltr.
84731	16,5 x 10,0	5,5	0,25
84732	22,0 x 13,0	7,5	0,6
84733	27,5 x 19,0	9,0	1,4



Teller „MARONE“

plate
plato
assiette



	Ø cm	↑ cm
84728	16,0	2,5
84729	20,5	2,5
84730	28,0	3,5



Schale „MARONE“

bowl
cuenco
bol



	Ø cm	↑ cm	ltr.
84109	11	5,5	0,2



Schale „MARONE“

bowl
cuenco
bol



	Ø cm	↑ cm	ltr.
84107	8,5	2,5	0,05
84108	11,5	3	0,04



Tablett „MARONE“

tray
bandeja
plateau



	cm	↑ cm
84117	19,5 x 9,5	2,0
84118	39,0 x 16,0	3,0



Tablett „MARONE“

tray
bandeja
plateau



	cm	↑ cm
84119	32,5 x 23,5	4,5



Schale „MARONE“

bowl
cuenco
bol



	Ø cm	↑ cm	ltr.
84174	30,5	8,5	2,0



Schale „MARONE“

bowl
cuenco
bol



	Ø cm	↑ cm	ltr.
84110	14	6	0,30
84111	19	8	0,80
84112	21	8,5	1,00
84113	24	9,5	1,40



Schale „MARONE“

bowl
cuenco
bol



	cm	↑ cm	ltr.
84114	23,5 x 23,5	6,5	0,70

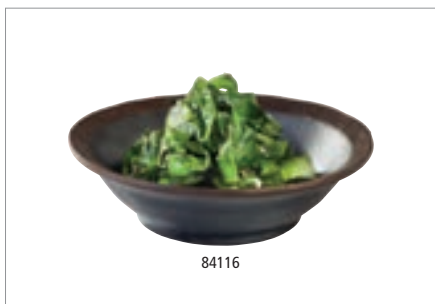

Schale „MARONE“

bowl
cuenco
bol



	Ø cm	↑ cm	ltr.
84115	11	3,5	0,13
84116	14	4	0,20

ZEN



Fernöstliche Tisch- und Buffetartikel präsentiert die Serie ZEN. Japanische und chinesische Köstlichkeiten können traditionell in Szene gesetzt werden. Die Optik entspricht dem japanischen Steingut.

The ZEN series presents Far Eastern table and buffet articles. Japanese and Chinese specialities can be served in a traditional setting. The appearance is that of Japanese stoneware.

La colección ZEN presenta artículos de bufé y mesa para cocina oriental. Las delicias japonesas y chinas se pueden poner en escena siguiendo la tradición. Su aspecto recuerda al gres japonés.

La collection ZEN présente des articles de buffet et de table pour la cuisine orientale. Les délices japonaises et chinoises entrent en scène selon la plus pure tradition. L'aspect de la mélamine rappelle le grès japonais.



Schale „ZEN“
bowl
cuenco
bol



	∅ cm	↑ cm	Farbe / Colour
83928	31	8,5	White
83929	31	8,5	Black



Schale „ZEN“
bowl
cuenco
bol



	∅ cm	↑ cm	ltr.	Farbe / Colour
84354	22,5	12,5	0,80	White
84355	22,5	12,5	0,80	Black



Schale „ZEN“
bowl
cuenco
bol



	cm	↑ cm	ltr.	Farbe / Colour
83710	21 x 21	11	1,4	White
83712	21 x 21	11	1,4	Black



84349

Schale „ZEN“

bowl
cuenco
bol



	Ø cm	↑ cm	ltr.	Farbe / Colour
84348	10	7	0,08	White
84350	12,5	8,5	0,15	White
84352	16	10	0,30	White
	Ø cm	↑ cm	ltr.	Farbe / Colour
84349	10	7	0,08	Black
84351	12,5	8,5	0,15	Black
84353	16	10	0,30	Black



Schale „ZEN“

bowl
cuenco
bol



	cm	↑ cm	ltr.	Farbe / Colour
83733	25 x 13,5	4	0,25	White
83737	30,5 x 17,5	5	0,60	White
	cm	↑ cm	ltr.	Farbe / Colour
83735	25 x 13,5	4	0,25	Black
83739	30,5 x 17,5	5	0,60	Black



Schale „ZEN“

bowl
cuenco
bol



	cm	↑ cm	ltr.	Farbe / Colour
83714	17,5 x 17,5	7	0,5	White
83716	17,5 x 17,5	7	0,5	Black



Schale „ZEN“

bowl
cuenco
bol



	cm	↑ cm	ltr.	Farbe / Colour
83725	10,5 x 10,5	3	0,06	White
83727	10,5 x 10,5	3	0,06	Black



Dipschälchen „ZEN“

dip bowl
cuenco para dip
bol para dip



	Ø cm	↑ cm	ltr.	Farbe / Colour
83721	8	1,5	0,03	White
83723	8	1,5	0,03	Black

Buffet & Tabletop Melamin



Schale „ZEN“

bowl
cuenco
bol



	cm	↑ cm	ltr.	Farbe / Colour
84342	9 x 9	2,5	0,06	■
84343	9 x 9	2,5	0,06	■



Schale „ZEN“

bowl
cuenco
bol



	cm	↑ cm	ltr.	Farbe / Colour
83726	13 x 11	3,5	0,1	■
83728	13 x 11	3,5	0,1	■



Schale „ZEN“

bowl
cuenco
bol



	cm	↑ cm	ltr.	Farbe / Colour
83718	12 x 12	4	0,2	■
83720	12 x 12	4	0,2	■



Schale „ZEN“

bowl
cuenco
bol



	cm	↑ cm	ltr.	Farbe / Colour
83938	32,5 x 14	4		■
83939	32,5 x 14	4		■



Schale „ZEN“

bowl
cuenco
bol



	cm	↑ cm	ltr.	Farbe / Colour
83730	11 x 10	3	0,04	■
83732	11 x 10	3	0,04	■



Schale „ZEN“

bowl
cuenco
bol



	cm	↑ cm	ltr.	Farbe / Colour
83722	17,5 x 15,5	5,5	0,2	■
83724	17,5 x 15,5	5,5	0,2	■



Schale „ZEN“

bowl
cuenco
bol



	cm	↑ cm	ltr.	Farbe / Colour
83934	14,5 x 12,5	5	0,2	White
83935	14,5 x 12,5	5	0,2	Black



Schale „ZEN“

bowl
cuenco
bol



	Ø cm	↑ cm	ltr.	Farbe / Colour
83932	11,5	4	0,15	White
83933	11,5	4	0,15	Black



Schale „ZEN“

bowl
cuenco
bol



	cm	↑ cm	ltr.	Farbe / Colour
83946	9 x 7	2,5	0,05	White
83947	9 x 7	2,5	0,05	Black



Schale „ZEN“

bowl
cuenco
bol



	cm	↑ cm	Farbe / Colour
83948	14 x 9	2,5	White
83949	14 x 9	2,5	Black

Buffet & Tabletop Melamin



Tablett / Teller „ZEN“

tray / plate
bandeja / plato
plateau / assiette



	∅ cm	↑ cm	Farbe / Colour
83940	28	3	White
83941	28	3	Black



Tablett „ZEN“

tray
bandeja
plateau



	cm	↑ cm	Farbe / Colour
83734	23,5 x 23	5,5	White
83736	23,5 x 23	5,5	Black



Tablett / Sushiboard „ZEN“

tray / sushiboard
bandeja para sushi
plateau sushi



	cm	↑ cm	Farbe / Colour
83742	22,5 x 9,5	3	White
83744	22,5 x 9,5	3	Black



Tablett / Sushiboard „ZEN“

tray / sushiboard
bandeja para sushi
plateau sushi



	cm	↑ cm	Farbe / Colour
83738	22 x 12	3	White
83740	22 x 12	3	Black

FUSION



Die Oberflächen der Serie FUSION sind innen hochglänzend und außen mattiert. Das besondere Design beansprucht höchste Aufmerksamkeit und bringt Speisen optimal zur Geltung. Somit werden die Speisen noch mehr in den Blickpunkt gerückt.

The FUSION presents table and buffet articles. The design and surface is unique. Mirror shiny inside, outside matt.

La línea FUSION presenta artículos para la mesa y el bufé. El diseño y el acabado son únicos, interior pulido brillante y exterior acabado en mate.

La ligne FUSION présente des articles pour le buffet. Le design et la finition sont tout à fait uniques. Intérieur poli brillant et extérieur mat.



Schale „FUSION“

bowl
cuenco
bol



	Ø cm	↑ cm	litr.
84022	11	7,0	0,3
84023	17	8,5	1,0
84024	20	8,0	1,2



Tablett „FUSION“

tray
bandeja
plateau



	cm	↑ cm
84025	23,5 x 7,5	2,0
84026	24,5 x 6,5	1,5

HALFTONE



Fingerfood Löffel „HALFTONE“
party spoon
cuchara party
cuillère party



	∅ cm	↑ cm
84158	5,5	7,0



Fingerfood Löffel „HALFTONE“
party spoon
cuchara party
cuillère party



	cm	↑ cm
84128	14,5 x 4,5	4,5



Teller „HALFTONE“
plate
plato
assiette



	∅ cm	↑ cm
84123	16	2,5



Tablett „HALFTONE“
tray
bandeja
plateau



	cm	↑ cm
84124	20,5 x 12,5	3
84125	24,5 x 15	3
84127	34,5 x 21,5	3



Tablett „HALFTONE“

tray
bandeja
plateau



	cm	↑ cm
84126	29 x 18	4

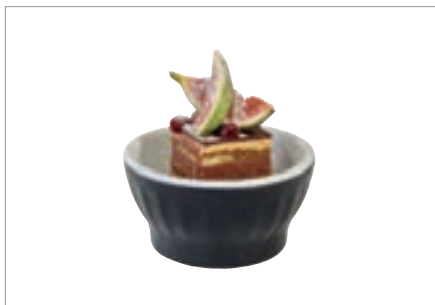

Schale „HALFTONE“

bowl
cuenco
bol



	Ø cm	↑ cm	ltr.
84217	8,0	4,0	0,1



Schale „HALFTONE“

bowl
cuenco
bol



	Ø cm	↑ cm	ltr.
84218	8,5	3,5	0,05



Schale „HALFTONE“

bowl
cuenco
bol



	Ø cm	↑ cm	ltr.
84129	16	3,5	0,05



Schale „HALFTONE“

bowl
cuenco
bol



	cm	↑ cm	ltr.
84130	11,5 x 7	4	0,05
84131	14 x 8	4,5	0,10
84132	15 x 9,5	5	0,15



Schale „HALFTONE“

bowl
cuenco
bol



	cm	↑ cm	ltr.
84133	17,5 x 13,5	6,5	0,35
84134	24 x 17,5	7,5	0,8

Buffet & Tabletop Melamin



Schale „HALFTONE“

bowl
cuenco
bol



	cm	↑ cm	ltr.
84135	16,5	7,5	0,65
84136	19	8,5	1



Schale „HALFTONE“

bowl
cuenco
bol



	cm	↑ cm	ltr.
84137	26	9	1,5



Blattschale „HALFTONE“

leaf
fuente en forma de hoja
plateau feuille



	cm	↑ cm
84120	37,5 x 15,5	4,5
84121	46,5 x 21	6,5



Blattschale „HALFTONE“

leaf
fuente en forma de hoja
plateau feuille



	cm	↑ cm
84122	34 x 13	3

SINUS



Charakterstark und mit dem hohen Anspruch an Funktionalität und Design präsentiert sich die Buffetserie SINUS. Die großzügigen Flächen für die Speisenpräsentation sind ausdrucksstark eingefasst und gewährleisten ein optimales Handling im Gastronomiealltag.

The FUSION presents table and buffet articles. The design and surface is unique. Mirror shiny inside, outside matt.

La línea FUSION presenta artículos para la mesa y el bufé. El diseño y el acabado son únicos, interior pulido brillante y exterior acabado en mate.

La ligne FUSION présente des articles pour le buffet. Le design et la finition sont tout à fait uniques. Intérieur poli brillant et extérieur mat.



GN Tablett „SINUS“

GN tray
GN bandeja
GN plateau



	cm	↑ cm	GN	Farbe / Colour
84230	53 x 32,5	2	1/1	White
84231	53 x 16,2	2	2/4	White
	cm	↑ cm	GN	Farbe / Colour
84260	53 x 32,5	2	1/1	Black
84261	53 x 16,2	2	2/4	Black



Schale „SINUS“

bowl
cuenco
bol



	cm	↑ cm	litr.
84229	10,5 x 10,5	4,0	0,1
84232	21,0 x 21,0	9,0	1,5
84233	25,0 x 25,0	11,0	2,4
84234	28,5 x 28,5	12,5	3,5

TAO



Schale, rund „TAO“

bowl, round
cuenco, redondo
bol, rond



	cm	↑ cm	ltr.	Farbe / Colour
83648	10,5 x 10,0	6,5 / 3,0	0,07	White
83651	13,5 x 12,5	8,5 / 4,0	0,15	White
83654	17,0 x 16,0	10,5 / 4,5	0,3	White
	cm	↑ cm	ltr.	Farbe / Colour
83649	10,5 x 10,0	6,5 / 3,0	0,07	Black
83652	13,5 x 12,5	8,5 / 4,0	0,15	Black
83655	17,0 x 16,0	10,5 / 4,5	0,3	Black



Schale „TAO“

bowl
cuenco
plat ovale creux



	cm	↑ cm	Farbe / Colour
83633	25,0 x 13,5	4,5	White
83636	30,5 x 17,5	5,0	White



Schale, quadratisch „TAO“

bowl, square
cuenco, cuadrado
bol creux carré



	cm	↑ cm	ltr.	Farbe / Colour
83642	30,5 x 30,5	10	3,3	White
83643	30,5 x 30,5	10	3,3	Black



Schale, rechteckig „TAO“

bowl, rectangular
cuenco, rectangular
bol creux rectangulaire



	cm	↑ cm	ltr.	Farbe / Colour
83639	32,5 x 17,5	10	1,8	White
83640	32,5 x 17,5	10	1,8	Black

GLOBAL BUFFET



Schale „GLOBAL BUFFET“

bowl
cuenco
bol



	cm	↑ cm	ltr.	Farbe / Colour
83785	32,5 x 32,5	12,0	3,0	White
83786	35,0 x 35,0	12,5	3,5	White
83787	40,0 x 40,0	13,5	5,0	White

	cm	↑ cm	ltr.	Farbe / Colour
84785	32,5 x 32,5	12,0	3,0	Black
84786	35,0 x 35,0	12,5	3,5	Black
84787	40,0 x 40,0	13,5	5,0	Black



Schale „GLOBAL BUFFET“

bowl
cuenco
bol



	cm	↑ cm	ltr.	Farbe / Colour
83799	25,5	13,0	3,0	White
83788	32,0	16,5	4,5	White
83789	35,0	17,0	6,0	White
83790	40,0	17,5	8,0	White

	cm	↑ cm	ltr.	Farbe / Colour
83779	25,5	13,0	3,0	Black
84788	32,0	16,5	4,5	Black
84789	35,0	17,0	6,0	Black
84790	40,0	17,5	8,0	Black



Schale „GLOBAL BUFFET“

bowl
cuenco
bol



	cm	↑ cm	ltr.	Farbe / Colour
83791	32 x 32	12,0	2,5	White
83792	36 x 36	12,5	4,0	White
83793	40 x 40	14,0	5,5	White

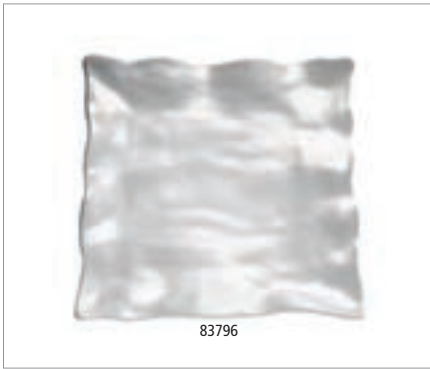

83796

Tablett „GLOBAL BUFFET“

tray
bandeja
plateau



	cm	↑ cm	Farbe / Colour
83794	30,5 x 30,5	4	White
83795	36,0 x 36,0	5	White
83796	38,5 x 29,5	5	White
83797	44,0 x 34,5	5	White



83485

Tablett „GLOBAL BUFFET“

tray
bandeja
plateau



die Melaminplatten wirken optisch wie der Naturstein Granit
fantastic imitation of granit stone
melamina: excelente imitación del granito natural
mélamine imitation granit naturel

	cm	↑ cm	Farbe / Colour
84383	30,5 x 30,5	4	Black
84385	40 x 40	4	Black



Schale „GLOBAL BUFFET“

bowl
cuenco
bol



die Melaminschale wirkt optisch wie der Naturstein Granit
fantastic imitation of granit stone
melamina: excelente imitación del granito
mélamine imitation granit naturel

	cm	↑ cm	ltr.	Farbe / Colour
84387	36 x 36	11	3,5	Black



Schale „GLOBAL BUFFET“

bowl
cuenco
bol



	cm	↑ cm	ltr.	Farbe / Colour
84462	44 x 25	20	3,3	White



84466

Schale „GLOBAL BUFFET“

bowl
cuenco
bol



	cm	↑ cm	ltr.	Farbe / Colour
84464	35,5 x 31,5	14	2,5	White
84466	46 x 40	18,5	5,5	White

APART



GN Tablett „APART“

GN tray
GN bandeja
GN plateau



	cm	↑ cm	GN
83828	53,0 x 32,5	2,5	1/1
83830	32,5 x 26,5	2,5	1/2
83832	32,5 x 17,6	2,5	1/3



Tablett „APART“

tray
bandeja
plateau



	cm	↑ cm
83834	23,0 x 23,0	2,5
83836	33,0 x 33,0	2,5
83838	53,0 x 53,0	2,5



Tablett, rund „APART“

tray, round
bandeja, redonda
plateau rond



	Ø cm	↑ cm
83840	37	2,5

Frischhalte-Haube / cover / campana / cloche

	Ø cm	↑ cm	
06515	33	12,5	
06517	33	12,5	mit verchromtem Griff / with chrom plated handle con botón cromado / avec bouton chromé



Schale, rund „APART“

bowl, round
cuenco, redondo
bol, rond



	Ø cm	↑ cm	ltr.
83800	6,5	3,0	0,045
83802	10,0	4,5	0,13
83804	15,0	6,5	0,5
83806	20,0	9,0	1,2



Schale „APART“

bowl
cuenco
bol



	cm	↑ cm	ltr.
83808	6,6 x 6,6	3,0	0,05
83810	10 x 10	4,5	0,17
83812	15 x 15	6,5	0,5
83814	20 x 20	9,0	1,6
83816	25 x 25	9,0	2,6
83818	25 x 25	12,5	3,8
83820	30 x 30	12,5	4,5



Schale „APART“

bowl
cuenco
bol



	cm	↑ cm	ltr.
83822	30 x 15	6,5	1,2
83824	40 x 20	6,5	2,4



GN 2/4 Schale „APART“

GN 2/4 bowl
GN 2/4 cuenco
GN 2/4 bol



	cm	↑ cm	GN	ltr.
83826	53,0 x 16,2	6,5	2/4	3,0

CASCADE



Schale „CASCADE“

bowl
cuenco
bol



	cm	↑ cm	GN	ltr.
83963	28,5 x 25,5	7,5		2,90
83960	32,5 x 26,5	7,5	1/2	3,65
83962	26,5 x 16,2	7,5	1/4	1,50



Tablett „CASCADE“

tray
bandeja
plateau



	cm	↑ cm	GN	fits to
83964	28,5 x 25,5	2,4		83963
83965	32,5 x 26,5	2,4	1/2	83960
83967	26,5 x 16,2	2,4	1/4	83962



Tablett kann als Deckel eingesetzt werden!

Tray is also useable as a cover!

¡La bandeja se puede usar como tapa!

Le plat s'utilise aussi comme couvercle!



GN 2/4 Schale „CASCADE“

GN 2/4 bowl
GN 2/4 cuenco
GN 2/4 bol



	cm	↑ cm	GN	ltr.
83961	53,0 x 16,2	7,5	2/4	3,65



GN 2/4 Tablett „CASCADE“

GN 2/4 tray
GN 2/4 bandeja
GN 2/4 plateau



	cm	↑ cm	GN	fits to
83966	53,0 x 16,2	2,4	2/4	83961

FLOAT



- stapelbar mit Löffel und Deckel
- Schalenboden fixiert sich auf dem Deckel
- rutschfest (Antirutschfüßchen)

- with spoon and cover stackable
- non-slip feet

- con tapa apilable
- la base se fija a la tapa
- apilado estable (pies anti-deslizantes)

- avec couvercle qui permet un empilage parfait
- le pied du bol supérieur s'encadre dans le couvercle
- antidérapant



Schale „FLOAT“

bowl
cuenco
bol



	Ø cm	↑ cm	ltr.	Farbe / Colour
83900	5,5	3,0	0,03	White
83902	9,0	4,5	0,15	White
83904	13,0	6,5	0,45	White
83906	15,0	7,5	0,70	White
83908	20,5	10,0	1,90	White
<hr/>				
	Ø cm	↑ cm	ltr.	Farbe / Colour
83901	5,5	3,0	0,03	Black
83903	9,0	4,5	0,15	Black
83905	13,0	6,5	0,45	Black
83907	15,0	7,5	0,70	Black
83909	20,5	10,0	1,90	Black



Schale „FLOAT“

bowl
cuenco
bol



	cm	↑ cm	ltr.	Farbe / Colour
83910	5,5 x 5,5	3,0	0,03	White
83912	9,0 x 9,0	4,5	0,16	White
83914	12,5 x 12,5	6,0	0,50	White
83916	19 x 19	9,5	1,90	White
83918	25 x 25	12,0	4,70	White
	cm	↑ cm	ltr.	Farbe / Colour
83911	5,5 x 5,5	3,0	0,03	Black
83913	9,0 x 9,0	4,5	0,16	Black
83915	12,5 x 12,5	6,0	0,50	Black
83917	19 x 19	9,5	1,90	Black
83919	25 x 25	12,0	4,70	Black



GN Tablett „FLOAT“

GN tray
GN bandeja
GN plateau



	cm	↑ cm	GN	Farbe / Colour
83923	53,0 x 32,5	3	1/1	White
83925	32,5 x 26,5	3	1/2	White
	cm	↑ cm	GN	Farbe / Colour
83924	53,0 x 32,5	3	1/1	Black
83926	32,5 x 26,5	3	1/2	Black



Deckel „FLOAT“ mit Löffelaussparung

cover, with notched for spoons
tapa, con espacio para la cuchara
couvrele, avec encoche pour la louche



	Ø cm	↑ cm	fits to
83920	20,5	1,3	83908, 83909



Deckel „FLOAT“ mit Löffelaussparung

cover, with notched for spoons
tapa, con espacio para la cuchara
couvrele, avec encoche pour la louche



	cm	↑ cm	fits to
83921	19 x 19	1,3	83916, 83917
83922	25 x 25	1,3	83918, 83919

PURE



Tablett „PURE“

tray
bandeja
plateau



	cm	↑ cm	GN	Farbe / Colour
83401	53,0 x 32,5	3	1/1	White
83588	35,4 x 32,5	3	2/3	White
83433	53,0 x 16,2	3	2/4	White
83480	32,5 x 26,5	3	1/2	White
83481	32,5 x 17,6	3	1/3	White
83482	26,5 x 16,2	3	1/4	White
83882	65,0 x 26,5	3		White
83597	40 x 30	3	Bäcker-Maß	White
83598	60 x 20	3	Bäcker-Maß	White
83599	60 x 40	3	Bäcker-Maß	White
	cm	↑ cm	GN	Farbe / Colour
83479	53,0 x 32,5	3	1/1	Black
83589	35,4 x 32,5	3	2/3	Black
83434	53,0 x 16,2	3	2/4	Black
83490	32,5 x 26,5	3	1/2	Black
83491	32,5 x 17,6	3	1/3	Black
83492	26,5 x 16,2	3	1/4	Black
83592	40 x 30	3	Bäcker-Maß	Black
83593	60 x 20	3	Bäcker-Maß	Black
83594	60 x 40	3	Bäcker-Maß	Black



Tablett „PURE“

tray
bandeja
plateau



	cm	↑ cm	Farbe / Colour
83625	31,0 x 10,5	2	
83403	35,5 x 18,0	3	
83417	30,0 x 21,0	3	
83402	53,0 x 18,0	3	
	cm	↑ cm	Farbe / Colour
83626	31,0 x 10,5	2	
83483	53,0 x 18,0	3	

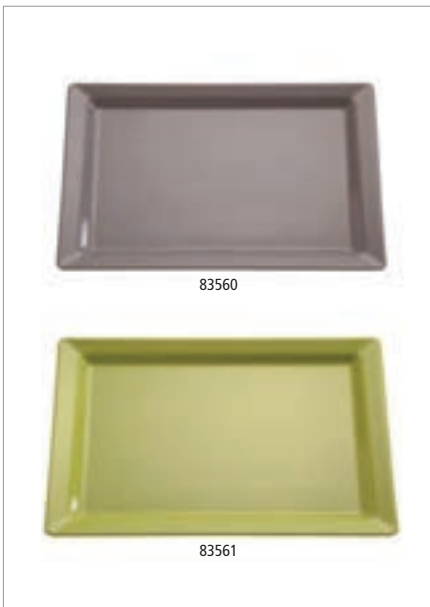

Tablett „PURE COLOR“

tray
bandeja
plateau



	cm	↑ cm	GN	Farbe / Colour
83560	53,0 x 32,5	3	1/1	
83562	32,5 x 26,5	3	1/2	
83564	53,0 x 18,0	3		
83566	35,5 x 18,0	3		
83561	53,0 x 32,5	3	1/1	
83563	32,5 x 26,5	3	1/2	
83565	53,0 x 18,0	3		
83567	35,5 x 18,0	3		



Tablett quadratisch „PURE“

tray square
bandeja cuadrada
plateau carré



	cm	↑ cm	Farbe / Colour
83418	18,0 x 18,0	3	
83407	21,0 x 21,0	3	
83406	26,5 x 26,5	3	
83405	37,0 x 37,0	3	
83404	51,0 x 51,0	3	
	cm	↑ cm	Farbe / Colour
83400	51,0 x 51,0	3	



Tablett / Teller „PURE“

tray / plate
bandeja / plato
plateau / assiette



	Ø cm	↑ cm	Farbe / Colour
83884	31	2,5	
83869	38	2,5	
83886	41	2,5	
83484	51	2,5	

Buffet & Tabletop Melamin



Schale „PURE“

bowl
cuenco
bol



	Ø cm	↑ cm	ltr.	Farbe / Colour
83450	5,5	4,0	0,02	White
83419	9,5	4,5	0,09	White
83453	13,0	6,5	0,30	White
83455	15,0	7,5	0,45	White
83415	20,0	10,5	1,25	White
	Ø cm	↑ cm	ltr.	Farbe / Colour
83451	5,5	4,0	0,02	Black
83452	9,5	4,5	0,09	Black
83454	13,0	6,5	0,30	Black
83456	15,0	7,5	0,45	Black
83457	20,0	10,5	1,25	Black



Schale „PURE“

bowl
cuenco
bol



	cm	↑ cm	ltr.	Farbe / Colour
84424	6,5 x 6,5	3,0	0,05	White
84425	32,0 x 32,0	14,0	8,0	White
	cm	↑ cm	ltr.	Farbe / Colour
84426	6,5 x 6,5	3,0	0,05	Black
84427	32,0 x 32,0	14,0	8,0	Black



Schale „PURE COLOR“

bowl
cuenco
bol



	cm	↑ cm	ltr.	Farbe / Colour
83414	9,0 x 9,0	4,0	0,14	White
83410	12,5 x 12,5	6,5	0,40	White
83409	19,0 x 19,0	9,0	1,50	White
83408	25,0 x 25,0	12,0	3,80	White
	cm	↑ cm	ltr.	Farbe / Colour
83466	9,0 x 9,0	4,0	0,14	Black
83467	12,5 x 12,5	6,5	0,40	Black
83468	19,0 x 19,0	9,0	1,50	Black
83469	25,0 x 25,0	12,0	3,80	Black
	cm	↑ cm	ltr.	Farbe / Colour
83568	9,0 x 9,0	4,0	0,14	Grey
83570	12,5 x 12,5	6,5	0,40	Grey
83572	19,0 x 19,0	9,0	1,50	Grey
83574	25,0 x 25,0	12,0	3,80	Grey
	cm	↑ cm	ltr.	Farbe / Colour
83569	9,0 x 9,0	4,0	0,14	Green
83571	12,5 x 12,5	6,5	0,40	Green
83573	19,0 x 19,0	9,0	1,50	Green
83575	25,0 x 25,0	12,0	3,80	Green



Schale „PURE BICOLOR“

bowl
cuenco
bol



	cm	↑ cm	ltr.	Farbe / Colour
84414	9,0 x 9,0	4,0	0,14	■ ■
84410	12,5 x 12,5	6,5	0,40	■ ■
84409	19,0 x 19,0	9,0	1,50	■ ■
84408	25,0 x 25,0	12,0	3,80	■ ■

	cm	↑ cm	ltr.	Farbe / Colour
84420	9,0 x 9,0	4,0	0,14	■ ■
84421	12,5 x 12,5	6,5	0,40	■ ■
84422	19,0 x 19,0	9,0	1,50	■ ■
84423	25,0 x 25,0	12,0	3,80	■ ■

	cm	↑ cm	ltr.	Farbe / Colour
84415	9,0 x 9,0	4,0	0,14	■ ■
84416	12,5 x 12,5	6,5	0,40	■ ■
84417	19,0 x 19,0	9,0	1,50	■ ■
84418	25,0 x 25,0	12,0	3,80	■ ■



Deckel „PURE“ mit Löffelaussparung

cover with notched for spoons
tapa con espacio para la cuchara
couverture avec encoche pour la louche



	cm	↑ cm	fits to
83600	19 x 19	1,5	84409, 84417, 84422, 83409, 83468, 83572, 83573
83601	25 x 25	1,5	84408, 84418, 84423, 84430, 83575, 83574, 83469, 83408
83602 NEW	32 x 32	1,5	84425, 84427



Schale / Pastateller „PURE“

bowl / pasta plate
cuenco / plato para pasta
bol / assiette creuse



	Ø cm	↑ cm	ltr.	Farbe / Colour
83412	32,0	7,5	1,5	■

83411	45,5	9,0	1,7	■
-------	------	-----	-----	---

Buffet & Tabletop Melamin



Schale „PURE“

bowl
cuenco
bol



	cm	↑ cm	ltr.
83497	22,5 x 15,5	7,5	0,80
83498	38,5 x 15,5	7,5	1,50
83499	51,0 x 15,5	7,5	2,40



GN Tablett „PURE GRANIT“

GN tray
GN bandeja
GN plateau



	cm	↑ cm	GN
84440	53,0 x 32,5	3	1/1
84441	32,5 x 26,5	3	1/2
84442	53,0 x 16,2	3	2/4



Schale „PURE GRANIT“

bowl
cuenco
bol



	cm	↑ cm	ltr.
84429	19 x 19	9	1,50
84430	25 x 25	12	3,80



Menage „PURE“

menage
conjunto aperitivo
set apéritif



4-teilig: 1 Ständer, Edelstahl matt poliert + 3 Melamin-Schalen, weiß (Nr. 83419)
4 pcs. set: 1 stainless stand satin polished finish + 3 white bowls (No. 83419)
4 unidades: 1 soporte, acero inoxidable mate + 3 cuencos de melamina blancos (N° 83419)
4 pièces: 1 support inox mat + 3 coupelles rondes mélamine blanche (ref. 83419)

	cm	↑ cm
09924	14 x 14	16



Menage „PURE“

menage
conjunto aperitivo
set apéritif



5-teilig: 1 Ständer, Edelstahl matt poliert + 4 Melamin-Schalen, weiß (Nr. 83414)
5 pcs. set: 1 stainless stand satin polished finish + 4 square white bowls (No. 83414)
5 unidades: 1 soporte, acero inoxidable mate + 4 cuencos de melamina blancos (N° 83414)
5 pièces: 1 support inox mat + 4 coupelles rondes mélamine blanche (ref. 83414)

	cm	↑ cm
09923	17 x 17	16



Tablett „PURE“

tray
bandeja
plateau



Edelstahl matt poliert, passend für Melamin-Schalen
stainless steel satin polished finish, for melamin bowls
acero inoxidable mate, apta para cuencos de melamina
inox mat, concient pour bols mélamine

	cm	
30120	20 x 11	für 2 Schalen / for 2 bowls para 2 cuencos / pour 2 bols
30122	20 x 20	für 4 Schalen / for 4 bowls para 4 cuencos / pour 4 bols
30121	29 x 20	für 6 Schalen / for 6 bowls para 6 cuencos / pour 6 bols

Schale „PURE COLOR“ / bowl / cuenco / bol

	cm	↑ cm	ltr.	Farbe / Colour
83414	9,0 x 9,0	4,0	0,14	
83466	9,0 x 9,0	4,0	0,14	
83568	9,0 x 9,0	4,0	0,14	
83569	9,0 x 9,0	4,0	0,14	

Schale „PURE BICOLOR“ / bowl / cuenco / bol

	cm	↑ cm	ltr.	Farbe / Colour
84414	9,0 x 9,0	4,0	0,14	
84415	9,0 x 9,0	4,0	0,14	
84420	9,0 x 9,0	4,0	0,14	



GN Tablett „FRAMES“

GN tray
GN bandeja
GN plateau



	cm	↑ cm	GN
84046	53,0 x 32,5	2	1/1
84047	32,5 x 26,5	2	1/2
84048	32,5 x 17,6	2	1/3



Dressingtopf „CASUAL“

dressing pot
salsera
pot à sauce



	cm	↑ cm	ltr.	Farbe / Colour
83867	12	21,5	1	
83868	12	21,5	1	



Schale „SLATE“

bowl
cuenco
bol



	cm	↑ cm	ltr.
84244	19,0 x 19,0	9	1,5
84245	25,0 x 25,0	12	3,8

BASKET



Gastronorm - Außenmaße Gastronorm - size Gastronorm - medidas exteriores Gastronorme - Gastronorme dimensions extérieures



Schale „BASKET“

bowl
cuenco
bol



	cm	↑ cm	GN	ltr.	Farbe / Colour
84000	32,5 x 26,5	8,5	1/2	3,50	White
84002	53,5 x 16,2	8,5	2/4	3,20	White
84004	26,5 x 16,2	8,5	1/4	1,40	White
84006	25,0 x 25,0	10		2,80	White
	cm	↑ cm	GN	ltr.	Farbe / Colour
84001	32,5 x 26,5	8,5	1/2	3,50	Red
84003	53,5 x 16,2	8,5	2/4	3,20	Red
84005	26,5 x 16,2	8,5	1/4	1,40	Red
84007	25,0 x 25,0	10		2,80	Red

FRUITS



Schale „FRUITS“

bowl
cuenco
bol



	Ø cm	↑ cm	ltr.	
83951	15	7,5	0,45	außen Erdbeer-Dekor / outside strawberry decor exterior motivo de fresa / extérieur motif fraise
83952	15	7,5	0,45	außen Orangen-Dekor / outside orange decor exterior motivo de naranja / extérieur motif orange
83953	15	7,5	0,45	außen Zitronen-Dekor / outside lemon decor exterior motivo de limón / extérieur motif citron
83954	15	7,5	0,45	außen Kiwi-Dekor / outside kiwi decor exterior motivo de kiwi / extérieur motif kiwi



Schale „FRUITS“

bowl
cuenco
bol



	Ø cm	↑ cm	ltr.	
83968	28	14	3,30	außen rot / outside red / exterior rojo / extérieur rouge uni
83969	28	14	3,30	außen grün / outside green / exterior verde / extérieur vert uni

Buffet & Tabletop Melamin



Blattschale „NATURAL COLLECTION“

leaf
fuente en forma de hoja
plateau feuille



	cm	↑ cm	Farbe / Colour
84083	40 x 18,5	3,5	White
84086	52 x 25,0	4,0	White
	cm	↑ cm	Farbe / Colour
84085	40 x 18,5	3,5	Green
84088	52 x 25,0	4,0	Green



Palmblattschale „NATURAL COLLECTION“

palm leaf
fuente en forma de hoja de palmera
plateau feuille de palme



	cm	↑ cm	litr.	Farbe / Colour
84080	40 x 18,5	10	1,8	White
84082	40 x 18,5	10	1,8	Green



stapelbar, mit Löffelablage
stackable, for spoons
apilable, práctico para cubiertos de servicio
empilable, pratique pour déposer les couverts



Blattschale „NATURAL COLLECTION“

leaf
fuente en forma de hoja
plateau feuille



	cm	↑ cm	Farbe / Colour
83864	34,5 x 8	2,5	White
83862	34,5 x 8	2,5	Green



Palmblattschale „NATURAL COLLECTION“

palm leaf
fuente en forma de hoja de palmera
plateau feuille de palme



	Ø cm	↑ cm	litr.	Farbe / Colour
83447	30	10,0	1,5	White
83896	35	12,5	4,5	White
	Ø cm	↑ cm	litr.	Farbe / Colour
83449	30	10,0	1,5	Green
83894	35	12,5	4,5	Green



Blattschale „NATURAL COLLECTION“

leaf
fuente en forma de hoja
plateau feuille



	cm	↑ cm	Farbe / Colour
83435	36 x 16	3,0	White
83438	45 x 24	3,0	White
83441	53 x 29	3,5	White

	cm	↑ cm	Farbe / Colour
83437	36 x 16	3,0	Green
83440	45 x 24	3,0	Green
83443	53 x 29	3,5	Green



Palmblattschale „NATURAL COLLECTION“

palm leaf
fuente en forma de hoja de palmera
plateau feuille de palme



	cm	↑ cm	Farbe / Colour
83871	27 x 27	4,5	White
83444	35 x 34	4,5	White
83873	42 x 42	4,5	White

	cm	↑ cm	Farbe / Colour
83865	27 x 27	4,5	Green
83446	35 x 34	4,5	Green
83866	42 x 42	4,5	Green



Schale, oval „CLASSIC WAVE“

bowl, oval
cuenco, ovalada
plateau ovale



	cm	↑ cm	ltr.
83875	27 x 17	4,0	0,80
83876	34 x 21	4,5	1,30
83877	47 x 29	5,0	3,20



Buffet & Tabletop Melamin



0,4 - 5,0 ltr.

Schale „BALANCE“

bowl
cuenco
bol



	Ø cm	↑ cm	ltr.	Farbe / Colour
84040	14,5	9,0	0,4	■
84041	21,0	13,0	1,5	■
84042	24,5	15,0	2,5	■
84043	30,0	19,5	5,0	■

	Ø cm	↑ cm	ltr.	Farbe / Colour
85040	14,5	9,0	0,4	■
85041	21,0	13,0	1,5	■
85042	24,5	15,0	2,5	■
85043	30,0	19,5	5,0	■

Buffetständer „KING“ / buffet stand / soporte para bufé / présentoir buffet

	Ø cm	↑ cm
03622	15	14
03623	15	21



84490

84492

84494

Schale „PURE“

bowl
cuenco
bol



weiße Schale mit blauem Rand, hochglänzend, klassischer Emaille-Look
white bowl with a blue edge, mirror polished finished, classic enamel look
cuenco blanco con borde azul, pulido brillante, estilo esmalte clásico
bol blanc avec bord bleu, brillant, émail look classique

	Ø cm	↑ cm	ltr.
84490	5,5	4	0,02
84491	9,5	4,5	0,09
84492	13	6,5	0,30
84493	15	7,5	0,45
84494	20	10,5	1,25

CASUAL



Schälchen „CASUAL MINI“

bowl
cuenco
bol mini



	cm	↑ cm	ltr.	Farbe / Colour
83880	6,0	2,5	0,02	White
83881	7,5	3,5	0,05	White



Schale „CASUAL MAXI“

bowl
cuenco
bol



	Ø cm	↑ cm	ltr.	Farbe / Colour
83696	10	4,5	0,15	White
83698	12	5,5	0,25	White
83704	20	9,2	1,80	White
83702	23	10,5	2,50	White
<hr/>				
	Ø cm	↑ cm	ltr.	Farbe / Colour
83697	10	4,5	0,15	Black
83699	12	5,5	0,25	Black
83705	20	9,2	1,80	Black
83703	23	10,5	2,50	Black

Deckel „FLOAT“ mit Löffelaussparung / cover, with notched for spoons / tapa, con espacio para la cuchara / couvercle, avec encoche pour la louche

	Ø cm	↑ cm	fits to
83920	20,5	1,3	83704, 83705



Dip-Schälchen „CASUAL“

dip bowl
cuencos para dip
ramequin



	Ø cm	↑ cm	ltr.	Farbe / Colour
83780	6,0	3,7	0,04	White
83781	7,0	3,7	0,05	White
83782	7,8	4,0	0,08	White
83783	8,5	4,5	0,11	White
83784	9,8	4,5	0,14	White
83798	6,0	3,7	0,04	Black
83777	6,0	3,5	0,03	Terracotta

Buffet & Tabletop Melamin



Sortierbox „MULTI“

shape sorter
caja surtida
boîte de tri



inklusive 3 herausnehmbare Trennwände, 4 Kammern
including 3 removable divider, 4 chambers
con 3 divisores extraíbles, 4 compartimentos
avec 3 parois de séparation amovibles, 4 compartiments

	cm	↑ cm	ltr.	Farbe / Colour
84531	31,5 x 17,5	7	2,1	White
84532	31,5 x 17,5	7	2,1	Black

Trenner, 6er Set / divider, 6 pcs. / divisor, 6 pz. / paroi de séparation, 6 pc.

	cm	✦ mm	Farbe / Colour
84533	16,5 x 5	3,5	White
84534	16,5 x 5	3,5	Black



Etagère „CASUAL“

etagère
expositor de bombones o bocaditos
présentoir à mignardises



inklusive Edelstahl-Schild, beschriftbar
including sign
placa incluida, sin inscripción
étiquette incluse, sans inscription

	Ø cm	↑ cm	
34248	31 - 41 - 51	55	3-stufig / 3-tier 3 niveles / 3 étages
34247	31 - 41	35	2-stufig / 2-tier 2 niveles / 2 étages



Fischplatte „CASUAL“

fish plate
fuente para pescado
plat creux à poisson



	cm	↑ cm
83997	48,0 x 22,5	2,5



Fischplatte „BIG“

fish plate
fuente para pescado
plat creux à poisson



	cm	↑ cm	ltr.
83996	58,5 x 28,0	5,5	2,0



Schale „LEAF“

bowl
cuenco
bol



	cm	↑ cm	ltr.	Farbe / Colour
84200	42,0 x 19,5	6,5	1,0	_____
84202	50,0 x 23,0	7,5	1,5	_____



Schale „BIG WAVE“

bowl
cuenco
bol



	cm	↑ cm	ltr.
83587	33,0 x 24,0	8,5	1



Schale „GLOBAL BUFFET“

bowl
cuenco
bol



	cm	↑ cm	ltr.
84462	44 x 25	20	3,3



Schale „GLOBAL BUFFET“

bowl
cuenco
bol



	cm	↑ cm	ltr.
84464	35,5 x 31,5	14	2,5
84466	46 x 40	18,5	5,5

Buffet & Tabletop Melamin



Schale „SCANTIC“

bowl
cuenco
bol



	cm	↑ cm	ltr.
84221	26,5 x 10,5	6,5	1,0
84222	53,0 x 10,5	6,5	2,0



Schale „ORGANIC“

bowl
cuenco
bol



	cm	↑ cm	ltr.	Farbe / Colour
84235	32,5 x 17	5,5	1,0	White
84236	50,0 x 26	6,5	3,5	White
84237	32,5 x 17	5,5	1,0	Black
84238	50,0 x 26	6,5	3,5	Black



Schale „CASUAL“

bowl
cuenco
bol



	Ø cm	↑ cm	ltr.
84215	10	6,5 / 8,5	0,2
84216	12	7,5 / 9,5	0,3



Tablett / Sushiboard

sushi board
bandeja para sushi
plateau sushi



	cm	↑ cm	Farbe / Colour
84980	24,0 x 10,5	2,5	White
84981	24,0 x 10,5	2,5	Black



Dipschale „CASUAL“

dip tray
bandeja para dips
plateau pour dips



	cm	↑ cm
84220	29,0 x 9,0	3,0

FLYING BUFFET

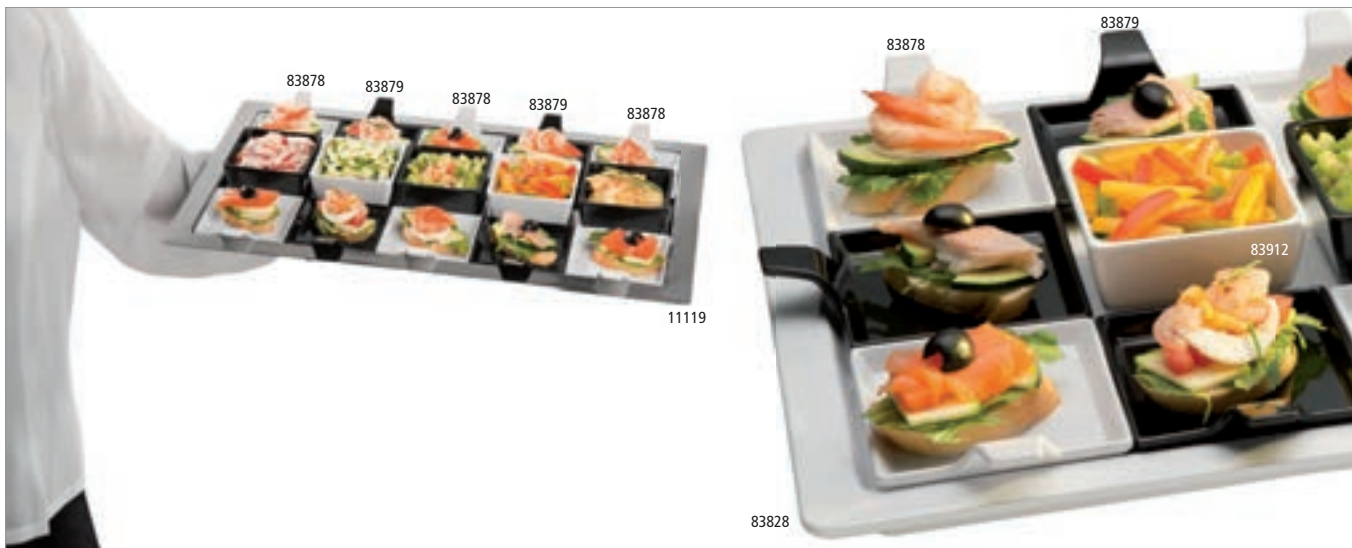

Fingerfood-Teller „FLYING BUFFET“

fingerfood plate
plato para el aperitivo
assiette pour apéritif



	cm	↑ cm	Farbe / Colour
83878	9,5 x 9,5	1,5 / 3,5	White
83879	9,5 x 9,5	1,5 / 3,5	Black



Schale „FLOAT“

bowl
cuenco
bol



	cm	↑ cm	Farbe / Colour
83912	9,0 x 9,0	4,5	White
83913	9,0 x 9,0	4,5	Black



GN Tablett „APART“

GN tray
GN bandeja
GN plateau



	cm	↑ cm	GN
83828	53,0 x 32,5	2,5	1/1



GN Edelstahl Tablett „FRAMES“

GN stainless steel platter
GN bandeja
GN plateau



	cm	GN
11119	53,0 x 32,5	1/1

Buffet & Tabletop Melamin



00468

00469

Torten- / Konditorplatte

cake stand
soporte para pastel
présentoir à gâteaux

Rand fixiert die Haube, mit Antirutsch-Füßchen
carved edge fixes the cover, non-slip feet
ranura para fijar bien la campana, pies antideslizantes
bord rainuré pour maintenir ferme la cloche, pieds antiglisse



	Ø cm	↑ cm	Farbe / Colour
00468	31	4	White
00469	31	4	Black



06510

06512

Frischhalte-Haube

cover
campana
cloche



	Ø cm	↑ cm	
06510	30	11,5	
06512	30	11,5	mit verchromtem Griff / with chrom plated handle con botón cromado / avec bouton chromé



83869

18388

Tablett / Teller „PURE“

tray / plate
bandeja / plato
plateau / assiette



	Ø cm	↑ cm	Farbe / Colour
83869	38	2,5	White

Rolltophaube / rolltop cover / campana abatible / cloche basculante

	Ø cm	↑ cm	
18388	38	20	mit verchromtem Kugelgriff / with chrome plated handle con pomo cromado / avec bouton chromé



83890

Servier- und Tortenplatte „CASUAL“

cake plate
porta pasteles
présentoir à gâteaux



	Ø cm	↑ cm
83890	31	8
83891	31	16



83892

Servier- und Tortenplatte „CASUAL“

cake plate
porta pasteles
présentoir à gâteaux



	cm	↑ cm
83892	31 x 31	8
83893	31 x 31	16

Fingerfood Löffel



Fingerfood Löffel „HALFTONE“

party spoon
cuchara party
cuillère party



	Ø cm	↑ cm	Farbe / Colour
84158	5,5	7,0	■ □



Fingerfood Löffel „HALFTONE“

party spoon
cuchara party
cuillère party



	cm	↑ cm	Farbe / Colour
84128	14,5 x 4,5	4,5	■ □



Fingerfood Löffel „BOAT“

party spoon
cuchara party
cuillère party



	cm	↑ cm	Farbe / Colour
84140	14,5 x 4,5	4,5	□
84141	14,5 x 4,5	4,5	■
84142	14,5 x 4,5	4,5	■
84143	14,5 x 4,5	4,5	■

Buffet & Tabletop Melamin



Fingerfood Löffel „HONG KONG“

party spoon
cuchara party
cuillère party



	cm	↑ cm	Farbe / Colour
83486	13 x 4,5	4,5	■
83487	13 x 4,5	4,5	■
83424	13 x 4,5	4,5	■
83426	13 x 4,5	4,5	■



Fingerfood-Löffel „MING HING“

party spoon
cuchara party
cuillère party



	cm	↑ cm	Farbe / Colour
83842	11 x 4,5	4	■
83843	11 x 4,5	4	■



Fingerfood-Löffel „YING YANG“

party spoon
cuchara party
cuillère party



	cm	↑ cm	Farbe / Colour
83844	10 x 4,5	1,5	■
83845	10 x 4,5	1,5	■



Fingerfood-Löffel „LEAF“

party spoon
cuchara party
cuillère party



	cm	↑ cm	Farbe / Colour
83889	10 x 4,5	1,5	■
83887	10 x 4,5	1,5	■
83888	10 x 4,5	1,5	■

MINI



Schale „MINI“
bowl
cuenco
bol

MELAMINE MF

	cm	↑ cm	litr.	Farbe / Colour
84750	8,0 x 8,0	3,0	0,06	White
84755	8,0 x 8,0	3,0	0,06	Black
84760	8,0 x 8,0	3,0	0,06	White/Blue



Schale „MINI“
bowl
cuenco
bol

MELAMINE MF

	cm	↑ cm	litr.	Farbe / Colour
84751	9,5 x 9,5	3,0	0,1	White
84756	9,5 x 9,5	3,0	0,1	Black
84761	9,5 x 9,5	3,0	0,1	White/Blue



Schale „MINI“
bowl
cuenco
bol

MELAMINE MF

	cm	↑ cm	litr.	Farbe / Colour
84752	9,5 x 8,0	3,0	0,08	White
84757	9,5 x 8,0	3,0	0,08	Black
84762	9,5 x 8,0	3,0	0,08	White/Blue



Schale / Schiffchen „MINI“
bowl
cuenco
bol

MELAMINE MF

	cm	↑ cm	litr.	Farbe / Colour
84753	12,5 x 5,5	4,0	0,06	White
84758	12,5 x 5,5	4,0	0,06	Black
84763	12,5 x 5,5	4,0	0,06	White/Blue



Schale / Schiffchen „MINI“
bowl
cuenco
bol

MELAMINE MF

	cm	↑ cm	litr.	Farbe / Colour
84754	14,0 x 6,5	4,0	0,1	White
84759	14,0 x 6,5	4,0	0,1	Black
84764	14,0 x 6,5	4,0	0,1	White/Blue

Buffet & Tabletop Melamin



Teller „MINI“
plate
plato
assiette



	cm	↑ cm	ltr.
84444	10,5 x 8,5	2,0	0,07



Schale „MINI“
bowl
cuenco
bol



	cm	↑ cm	ltr.
84445	10,5 x 6,0	4,0	0,07
84446	13,5 x 7,5	3,0	0,07
84448	9,5 x 9,0	5,5	0,09
84449	13,0 x 12,0	7,5	0,18



Schale „MINI“
bowl
cuenco
bol



	Ø cm	↑ cm	ltr.	Farbe / Colour
84775	8,5	2,5	0,07	White
84778	8,5	2,5	0,07	Black
84781	8,5	2,5	0,07	Dark Grey



Schale „MINI“
bowl
cuenco
bol



	Ø cm	↑ cm	ltr.	Farbe / Colour
84776	8,5	2,5	0,07	White
84779	8,5	2,5	0,07	Black
84782	8,5	2,5	0,07	Dark Grey



Schale „MINI“
bowl
cuenco
bol



	cm	↑ cm	ltr.	Farbe / Colour
84777	9,5 x 5,5	5,5	0,07	White
84780	9,5 x 5,5	5,5	0,07	Black
84783	9,5 x 5,5	5,5	0,07	Dark Grey



Schale „MINI“

bowl
cuenco
bol



	cm	↑ cm	ltr.
84460	35,0 x 4,5	3	0,20



Schale „MINI“

bowl
cuenco
bol



	cm	↑ cm	ltr.
84452	11,5 x 7,5	3	0,06
84454	11,5 x 6,0	5,5	0,04
84456	8,5 x 7,0	6	0,07
84458	8,0 x 8,0	4	0,10
84450	7,5 x 7,0	4,5	0,05

Schälchen „GOURMET“ / bowl / cuenco / bol

	Ø cm	↑ cm	ltr.
84018	7	6	0,05



Schale „HALFTONE“

bowl
cuenco
bol



	Ø cm	↑ cm	ltr.
84217	8,0	4,0	0,1
84218	8,5	3,5	0,05

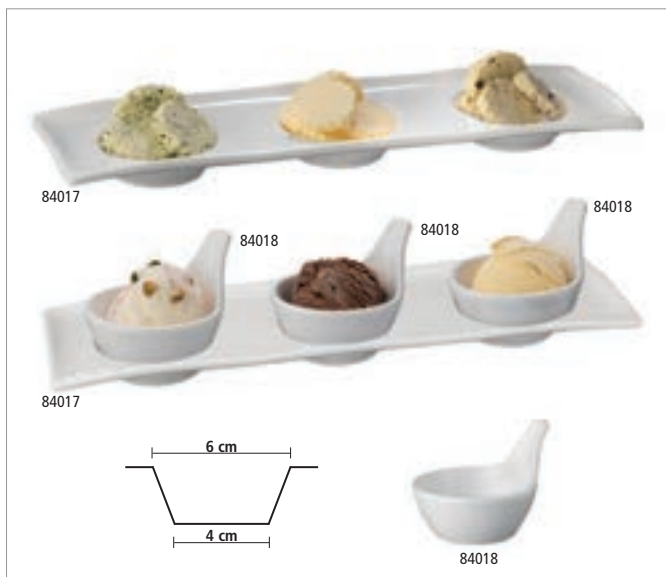

Tablett „GOURMET“

tray
bandeja
plateau



mit 3 Absätzen Ø 4 cm
with 3 holes Ø 4 cm
con 3 agujeros Ø 4 cm
avec 3 trous Ø 4 cm

	cm	↑ cm
84017	30,5 x 9,5	2,5

Schälchen „GOURMET“ / bowl / cuenco / bol

	Ø cm	↑ cm	ltr.
84018	7	6	0,05

Buffet & Tabletop Melamin



Besteckablage „SPOON“

cutlery rest
reposa cuchara
pose-cuillère



	cm	↑ cm
83801	26 x 10,5	5



Besteckablage „BOWL“

cutlery rest
reposa cuchara
pose-cuillère



	cm	↑ cm	ltr.
83803	22,5 x 11	6	0,5



Besteckablage „SMALL WAVE“

cutlery rest
reposa cuchara
pose-cuillère



	cm	↑ cm
83897	26 x 13	4,5



Salat-Löffel

salad spoon
cuchara para ensalade
cuillère à salade



	cm	↑ cm
84036	24 x 7	4



Salat-Löffel

salad spoon
cuchara para ensalade
cuillère à salade



	cm	↑ cm
84035	24 x 7	4,5



Servierlöffel „PROFI“

serving spoon
cuchara para servir
cuiller de service



	cm	→ cm	Farbe / Colour
84020	7 x 6,5	26,5	White
84021	7 x 6,5	26,5	Black



83500

Teller, rund „CASUAL“

plate, round
plato redondo
assiette ronde



	Ø cm	↑ cm	
83500	22,5	2,5	
83514	26,5	2,5	



Kaffeebecher „CASUAL“

coffee cup
taza de café
tasse à café



	Ø cm	↑ cm	ltr.
83513	9,5	10	0,4



Eierbecher, 4er Set

egg holder, 4pcs. set
huevera, set de 4 unidades
coquetier, pack de 4



	Ø cm	↑ cm	pcs.
83851	8	3	4



Eierbecher, 4er Set

egg holder, 4 pcs. set
huevera, set de 4 unidades
coquetier, pack de 4



	Ø cm	↑ cm	pcs.
83848	8,5	2	4



Eierbecher

egg holder
huevera
coquetier



	Ø cm	↑ cm
00032	8,5	2





Tabletop

Tabletop

Schalen
Teller
Mühlen
Leuchter
Tischsets

cuencos
bandejas
molinillos
candelabros
mantelíns

bowls
trays
mills
candle holders
placemats

bols
plateaus
moulins
chandeliers
sets de table

ELEMENT



Bekannt aus dem Bereich der Inneneinrichtung, lässt sich Beton nun auch im Buffetbereich stilvoll einsetzen. ELEMENT bietet drei unterschiedliche Präsentationsschalen, die sehr ansprechend in jede rustikale, natürliche aber auch urbane Buffetlandschaft integriert werden kann.

Known from the interior design sector, concrete can now also be used stylishly in the buffet area. ELEMENT offers three different presentation bowls, which can be very attractively integrated into any rustic, natural but also urban buffet landscape.

Conocido del sector de diseño interior, ahora el hormigón también puede ser utilizado en el área del bufé. ELEMENT ofrece tres cuencos de presentación diferentes, que pueden ser integrados atractivamente en cualquier paisaje de bufé rústico, natural, pero también urbano.

Connu dans le domaine du design d'intérieur, le béton peut désormais être utilisé avec élégance dans la zone du buffet. ELEMENT offre trois bols de présentation différents, qui peuvent être intégré très attrayente dans n'importe quel paysage de buffet rustique, naturel, mais aussi urbain.

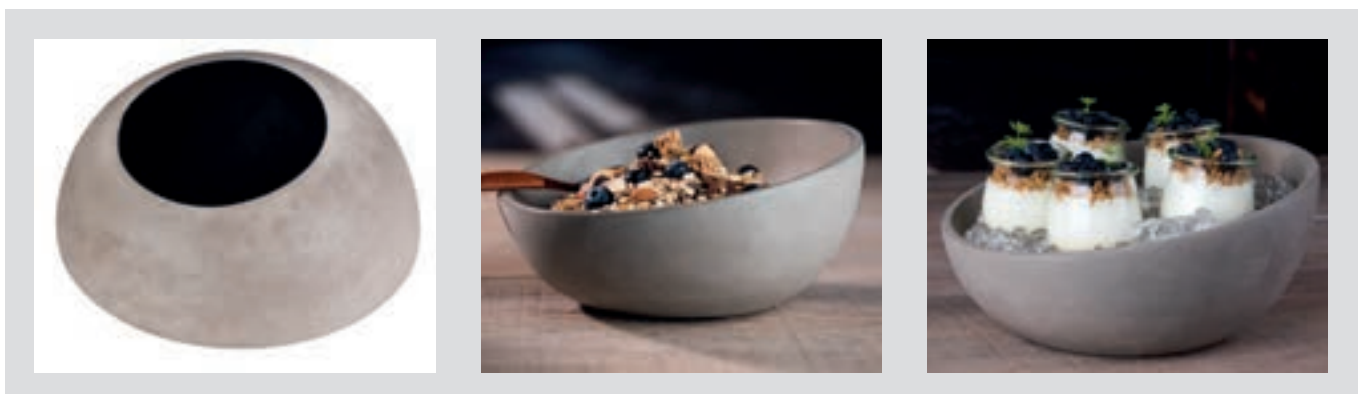



Schale „ELEMENT“

bowl
cuenco
bol



	Ø cm	↑ cm	ltr.
30000	22,0	6,0 / 10,5	1,1



Schale „ELEMENT“

bowl
cuenco
bol



	Ø cm	↑ cm	ltr.
30001	26,0	7,5 / 13,0	1,7



Schale „ELEMENT“

bowl
cuenco
bol



	Ø cm	↑ cm	ltr.
30002	29,5	8,5 / 14,5	2,5



Buffetständer

buffet stand
expositor de bufé
présentoir buffet



Akazienholz
acacia wood
madera de acacia
bois d'accacia

	Ø cm	↑ cm
33255	15	10



Buffetständer

buffet stand
expositor de bufé
présentoir buffet



Akazienholz
acacia wood
madera de acacia
bois d'accacia

	Ø cm	↑ cm
33256	25	15

SNACKHOLDER



Die Mini-Edestahlkörbchen dienen dem portionsweisen Servieren. Zum originellen Servieren von Beilagen geeignet, aber auch zum Frittieren selbst.

The mini frying baskets are used to present individual portions in an original way, but can still be used to fry.

Las cestas de freir ofrecen una presentación original para el servicio de tapas o raciones individuales de patatas, aperitivos, fritos, etc.

Les paniers à friture offrent une présentation originale pour servir apéritifs, snacks, tapas et autres rations individuelles. Également aptes pour frire.



Servier-Frittierkorb „SNACKHOLDER“

stainless steel fry baskets
cestitas inox para el servicio mesa
paniers inox pour le service sur table



	Ø cm	↑ cm	Griff
40600	8	7,5	9,5
40601	9	8,5	9,0



Servier-Frittierkorb „SNACKHOLDER“

stainless steel fry baskets
cestitas inox para el servicio mesa
paniers inox pour le service sur table



	cm	↑ cm	Griff
40610	21,5 x 10,5	4,5	9,5
40611	26,0 x 13,0	5,0	9,0



Servier-Frittierkorb „SNACKHOLDER“

stainless steel fry baskets
cestitas inox para el servicio mesa
paniers inox pour le service sur table



	cm	↑ cm	Griff
40620	10,0 x 8,5	6,5	9,0
40621	13,0 x 10,5	9,0	13,5

SNACKHOLDER



Made from PVD coated stainless steel

Die Mini-Edestahlkörbchen dienen dem portionsweisen Servieren. Zum originellen Servieren von Beilagen geeignet, aber auch zum Frittieren selbst.

The mini frying baskets are used to present individual portions in an original way, but can still be used to fry.

Las cestas de freir ofrecen una presentación original para el servicio de tapas o raciones individuales de patatas, aperitivos, fritos, etc.

Les paniers à friture offrent une présentation originale pour servir apéritifs, snacks, tapas et autres rations individuelles. Également aptes pour frire.



40602

Servier-Frittierkorb „SNACKHOLDER“

stainless steel fry baskets
cestitas inox para el servicio mesa
paniers inox pour le service sur table



	Ø cm	↑ cm	Griff	Farbe / Colour
40602	8	7,5	9,5	—
40603	9	8,5	9,0	—



40613

Servier-Frittierkorb „SNACKHOLDER“

stainless steel fry baskets
cestitas inox para el servicio mesa
paniers inox pour le service sur table



	cm	↑ cm	Griff	Farbe / Colour
40612	21,5 x 10,5	4,5	9,5	—
40613	26,0 x 13,0	5	9,5	—



40622

Servier-Frittierkorb „SNACKHOLDER“

stainless steel fry baskets
cestitas inox para el servicio mesa
paniers inox pour le service sur table



	cm	↑ cm	Griff	Farbe / Colour
40622	10,0 x 8,5	6,5	9,0	—
40623	13,0 x 10,5	9,0	13,5	—

Tabletop



Snackholder

serving cup
vaso para servir
gobelet à apéritif



Edelstahl, außen verkupfert

stainless steel, outside copper coated
acero inoxidable, el exterior está cubierto de cobre
acier inoxydable, l'extérieur est cuivré

	Ø cm	↑ cm	ltr.	Farbe / Colour	
40616	9,5	8,5 / 11,5	0,45		kupfer / copper
40617	8,5	8,5	0,35		kupfer / copper
40618	8,5	8,5	0,35		gehämmerte Oberfläche / hammered



Snackholder

serving cup
vaso para servir
gobelet à apéritif



	Ø cm	↑ cm	ltr.	
40605	9,5	8,5 / 11,5	0,45	
40606	8,5	8,5	0,35	
40607	8,5	8,5	0,35	gehämmerte Oberfläche / hammered



Servier- / Saucen-Eimer „SNACKHOLDER“

mini stainless steel bucket
cubo inox en formato mini
seau mini inox



	Ø cm	↑ cm	ltr.	pcs.
40630	7	6,5	0,15	4
40631	9	8,5	0,33	1



Mini-Milchkanne „SNACKHOLDER“

mini milk can
lechera en formato mini
pot à lait mini



	Ø cm	↑ cm	ltr.	pcs.
40640	4,5	5	0,08	4
40641	7,5	9,5	0,45	1



Mini-Seiher „SNACKHOLDER“

mini colander
colador en formato mini
passoire mini



	Ø cm	↑ cm
40650	10	6



Mini-Servierpfanne „SNACKHOLDER“

mini pan
sartén en formato mini
poêle à frire mini



	cm	↑ cm	ltr.
40660	14,5 x 9,5	4,5 / 6,5	0,5



Wachspapier „SNACKHOLDER“

greaseproof paper squares
papel alimenticio para cucurucho
papier alimentaire pour cornet

	cm	pcs.	
40670	42 x 25	500	Motiv: Zeitung
40671	42 x 25	500	blank
40672	42 x 25	500	Motiv: rote Karos / red
40673	42 x 25	500	Motiv: blaue Karos / blue



40672



40673

ENAMELWARE



Die Neu-Interpretation von Altbewährtem: Die Becher aus emailiertem Stahl eignen sich für alle Arten von Heißgetränken aber auch als trendige Behältnisse für unterschiedlichste Speisen. Ob Frittiertes, frische Gemüsesticks oder Desserts - die Becher vermitteln einfach eine gewisse Coolness und Trend!

The new interpretation of old-fashioned: The cups made of enameled steel are suitable for all types of hot beverages as well as trendy containers for a variety of food. Whether fried, fresh vegetable sticks or desserts - the cups simply convey a certain coolness and trend!

La nueva interpretación de algo tradicional: las tazas de acero esmaltado son aptas para todo tipo de bebidas calientes o como recipientes modernos para una variedad de diferentes platos. Sirven para fritos, palitos de verdura fresca o postres - las tazas transmiten una cierta frescura y tendencia!

La nouvelle interprétation du vieux: les gobelets en acier émaillé sont appropriés pour tous types de boissons chaudes ainsi que comme récipients pour une variété des plats. Ils servent pour tout ce qui est frit, bâtonnets de légumes frais ou desserts - les gobelets transmettent une certaine fraîcheur et tendance!



Henkelbecher „ENAMELWARE“

beaker
vaso coctelero
bol mélangeur



	Ø cm	↑ cm	ltr.	Farbe / Colour
40636	7	5	0,10	White/Blue
40632	9	8	0,35	White/Blue
40637	10	9	0,50	White/Blue



Henkelbecher „ENAMELWARE“

beaker
vaso coctelero
bol mélangeur



	Ø cm	↑ cm	ltr.	Farbe / Colour
40633	9	8	0,35	Red/Black



Henkelbecher „ENAMELWARE“

beaker
vaso coctelero
bol mélangeur



	Ø cm	↑ cm	ltr.	Farbe / Colour
40634	9	8	0,35	Green/Black



Henkelbecher „ENAMELWARE“

beaker
vaso coctelero
bol mélangeur



	Ø cm	↑ cm	ltr.	Farbe / Colour
40635	9	8	0,35	Blue/Black



Schale „ENAMELWARE“

bowl
cuenco
bol



	Ø cm	↑ cm	ltr.	Farbe / Colour
40638	13,0	6,0	0,50	White/Blue
40645 NEW	7,0	4,5	0,08	White/Blue
40646 NEW	8,0	3,5	0,08	White/Blue
40647 NEW	16,5	4,5	0,45	White/Blue



40664

Teller „ENAMELWARE“

plate
plato
assiette



	Ø cm	↑ cm	Farbe / Colour	
40664	20	2,0		flacher Teller
40665	24	2,0		flacher Teller
40666	26	2,0		flacher Teller



40662

Teller „ENAMELWARE“

plate
plato
assiette



	Ø cm	↑ cm	Farbe / Colour	
40661	18	3,5		tiefer Teller
40662	22	3,5		tiefer Teller
40663	24	3,5		tiefer Teller



Schale „ENAMELWARE“

bowl
cuenco
bol



	cm	↑ cm	ltr.	Farbe / Colour
40667	16 x 12	3,5	0,20	
40668	18 x 13,5	4,0	0,35	



Schale „ENAMELWARE“

bowl
cuenco
bol



	cm	↑ cm	ltr.	Farbe / Colour
40669	28 x 23	4,5	1,9	

Original Weck



Weck-Flaschen, 6er Set

Weck-bottles
Weck-botellas
Weck-bouteilles



6 Flaschen + 6 Deckel, ideal zum Servieren von Saft, Smoothie, Dressing und Saucen
6 bottles + 6 covers, ideal for serving juice, smoothie, dressing and sauces
6 botellas + 6 tapas, ideal para servir zumo, licuado, aliño y salsas
6 bouteilles + 6 couvercles, idéal pour servir de jus, smoothie, vinaigrette et sauces

	Ø cm	↑ cm	ltr.	pcs
82307	6	14,5	0,25	6



Weck-Flaschen, 6er Set

Weck-bottles
Weck-botellas
Weck-bouteilles



6 Flaschen + 6 Deckel, ideal zum Servieren von Saft, Smoothie, Dressing und Saucen
6 bottles + 6 covers, ideal for serving juice, smoothie, dressing and sauces
6 botellas + 6 tapas, ideal para servir zumo, licuado, aliño y salsas
6 bouteilles + 6 couvercles, idéal pour servir de jus, smoothie, vinaigrette et sauces

	Ø cm	↑ cm	ltr.	pcs
82308	6	19	0,5	6



Weck-Flaschen, 6er Set

Weck-bottles
Weck-botellas
Weck-bouteilles



6 Flaschen + 6 Deckel, ideal zum Servieren von Saft, Smoothie, Dressing und Saucen
6 bottles + 6 covers, ideal for serving juice, smoothie, dressing and sauces
6 botellas + 6 tapas, ideal para servir zumo, licuado, aliño y salsas
6 bouteilles + 6 couvercles, idéal pour servir de jus, smoothie, vinaigrette et sauces

	Ø cm	↑ cm	ltr.	pcs
82309	6	25,5	1,0	6



Weck-Gläser mit Deckel, 12er Set

Weck-glasses with lid
Weck tarros de vidrio con tapa
Weck verrines avec couvercle



12 Gläser + 12 Deckel
12 glasses + 12 covers
12 vasos + 12 tapas
12 verrines + 12 couvercles

	Ø cm	↑ cm	ltr.	pcs
82316	7	8,0	0,22	12



Weck-Gläser mit Deckel, 12er Set

Weck-glasses with lid
pack de 12 tarros de vidrio con tapa
pack de 12 pots en verre avec couvercle



12 Gläser + 12 Deckel
12 glasses + 12 cover
12 vasos + 12 tapas
12 verrines + 12 couvercles

	Ø cm	↑ cm	ltr.	pcs
82345	9	6,0	0,20	12



Weck-Gläser mit Deckel, 3er Set

Weck-glasses with lid, 3 pcs.
Weck tarros de vidrio con tapa
Weck verrines avec couvercle



3 Gläser + 3 Deckel
3 glasses + 3 covers
3 vasos + 3 tapas
3 verrines + 3 couvercles

	Ø cm	↑ cm	ltr.	pcs
82346	11	7,5	0,37	3



Weck-Gläser mit Deckel, 2er Set

Weck-glasses with lid, 2 pcs.
Weck tarros de vidrio con tapa
Weck verrines avec couvercle



2 Gläser + 2 Deckel
2 glasses + 2 covers
2 vasos + 2 tapas
2 verrines + 2 couvercles

	Ø cm	↑ cm	ltr.	pcs
82347	11	11	0,58	2

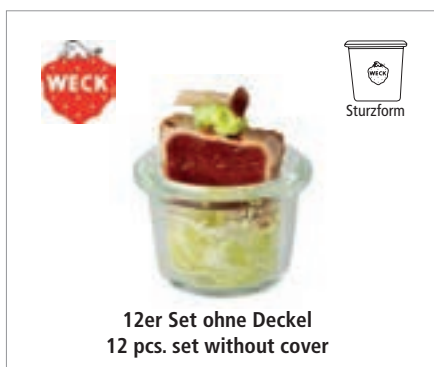

Gourmetgläser, 12er Set

gourmet glasses, 12 pcs.
tarros gourmet, set de 12 unidades
verres gourmet, pack de 12



	Ø cm	↑ cm	ltr.	pcs
82359	5	3,5	0,035	12
82370	6	5,5	0,08	12
82371	6	8,0	0,16	12

12er Set ohne Deckel
12 pcs. set without cover

Tabletop



Weck-Gläser mit Deckel, 12er Set

Weck-glasses with lid
Weck tarros de vidrio con tapa
Weck verrines avec couvercle



12 Gläser + 12 Deckel
12 glasses + 12 covers
12 vasos + 12 tapas
12 verrines + 12 couvercles

	Ø cm	↑ cm	ltr.	pcs
82310	6	5,5	0,08	12
82312	6	7,0	0,14	12
82314	6	8,0	0,16	12



passende Gläser:
82310
82312
82314

Serviergestell „WECK“

serving stand
expositor
présentoir



ohne Gläser
without glasses
sin vasos
sans verrines

	Ø cm	↑ cm	
33246	22	59	12 x Ø 6 cm



passende Gläser:
82310
82312
82314

Serviergestell „WECK“

serving stand
expositor
présentoir



ohne Gläser
without glasses
sin vasos
sans verrines

	Ø cm	↑ cm	
33247	22	33	6 x Ø 6 cm



Weck-Frischhaltedeckel, 5er Set

airtight cover, 5 pcs.
tapa hermética, 5 pz.
couverture hermétique, 5 pc.



für Rundrandgläser Ø 6 cm, 5er Set

for Ø 6 cm glasses, 5 pcs. set
para vasos Ø 6 cm, 5 pc.
pour verrines Ø 6 cm, set de 5

	Ø cm	pcs
82338	7	5



10er Set Gummidichringe

10 pcs. rubber washer
10 juntas de goma
jeu de 10 joints caoutchouc

für Deckel der Weck-Gläser, im Beutel verpackt

for covers of Weck-glasses
para las tapas de los tarritos Weck
pour la fermeture des verrines Weck

	fits to
82318	82307, 82308, 82309, 82310, 82312, 82314
82394	82345
82395	82346, 82347



8er Set Deckel-Klammer für 4 Weck-Gläser

8 pcs. cover clamps for 4 Weck-glasses
8 abrazaderas para 4 vasitos Weck
8 agrafes pour 4 verrines Weck



82319



Naturschieferplatte

natural slate tray
bandeja pizarra natural
plat ardoise naturelle



mit Absatz Ø 6 cm

with hole Ø 6 cm
con agujero Ø 6 cm
avec trou Ø 6,0 cm

	cm	mm
00986	25 x 12	6 - 9

passende Gläser:
82310, 82312, 82314,
82316



Naturschieferplatte

natural slate tray
bandeja pizarra natural
plat ardoise naturelle



mit 3 Absätzen, Ø 6 cm

with 3 holes, Ø 6 cm
con 3 agujeros, Ø 6 cm
avec 3 trous, Ø 6 cm

	cm	mm
00987	28 x 10	6 - 9

passende Gläser:
82310, 82312, 82314,
82316

Tabletop



Tablett „ELEGANCE“

tray
bandeja
plateau



	cm
02310	41 x 26
02311	48 x 30
02312	60 x 37



00067
Haube

00064
Königskuchenplatte

Tablett mit Haube „ELEGANCE“

tray with cover
bandeja con cubierta
plateau avec cloche



	cm	↑ cm
23642	35 x 19	10



00064
Königskuchenplatte

00067
Frischhaltebox

Serviertablett „FLASH“

tray
bandeja
plateau

	cm	↑ cm
00064	34 x 16,5	10
00067	25 x 19	7

Haube für 00064 / cover for 00064 / campana para 00064 / cloche pour 00064

06401

Haube für 00067 / cover for 00067 / campana para 00067 / cloche pour 00067

06701



7cm Haubenhöhe + 11cm Haubenhöhe

Tortenplatte mit Haube

cake plate with cover
bandeja tarta con campana
plat à tarte avec cloche



	Ø cm	↑ cm	
00065	30	11	mit 1 Haube / with 1 cover
00652	30	7 + 11	mit 2 Hauben / with 2 cover



Tortenplatte „BAROK“

cake plate
bandeja tartas
plat à gâteau



2-teilig: Tortenplatte mit Barock-Rand + Haube (extra stabil)
2 pcs. set: cake plate with decor edge „Barok“ + cover (extra robust)
set 2 piezas: porta tartas, borde decor „Barok“ + campana (extra fuerte)
set 2 pcs: plateau bord décor „Barok“ + cloche ultra-résistante

	Ø cm	↑ cm
06503	32	10

Frischhalte-Haube / cover / campana / cloche

	Ø cm	↑ cm
06510	30	11,5



Servier- / Tortenplatte

cake stand
soporte para pastel
présentoir à gâteaux



hochglanzpoliert, mit hohem Fuß (fest verbunden)

mirror polished finish, with tall foot
acabado brillante, con pie alto
poli brillant, pied haut

	Ø cm	↑ cm
00466	34,5	13,5



Servier- / Tortenplatte

cake stand
soporte para pastel
présentoir à gâteaux



Fuß hochglanzpoliert, Platte matt poliert, stabil und sehr standsicher

foot mirror polished finish, plate satin polished finish
pie pulido brillante, bandeja pulida mate
pied brillant, plateau poli satin mat

	Ø cm	↑ cm
00462	30	11



Servier- / Tortenplatte

cake stand
soporte para pastel
présentoir à gâteaux



matt poliert, drehbar, möbelschonende Moosgummi-Unterseite

satin polished finish, rotating, foam rubber below to save your furniture
acabado pulido satinado, giratorio, base revestida de goma para no rallar el mobiliario
poli satiné, plateau tournant, revêtement mousse sous le pied pour ne pas rayer les meubles

	Ø cm	↑ cm
00463	30,5	9



Servier- / Tortenplatte

cake stand
soporte para pastel
présentoir à gâteaux



Fuß matt poliert, stabil und sehr standsicher, möbelschonende Moosgummi-Unterseite

foot satin polished finish, foam rubber below to save your furniture
pie pulido con efecto satinado, base revestida de goma para no rallar el mobiliario
inox poli satin, revêtement mousse sous le pied pour ne pas rayer les meubles

	Ø cm	↑ cm
00464	30	11

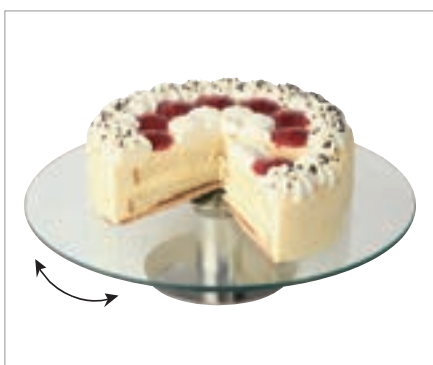

Servier- / Tortenplatte

cake stand
soporte para pastel
présentoir à gâteaux



Fuß matt poliert, drehbar, möbelschonende Moosgummi-Unterseite

foot satin polished finish, rotating, foam rubber below to save your furniture
vidrio, pie inox satinado giratorio, base de goma para proteger el mobiliario
plateau en verre, pied tournant inox poli satin, revêtement mousse sous le pied anti-rayures

	Ø cm	↑ cm
00444	30	7



Konditorplatte
cake stand
soporte para pastel
présentoir à gâteaux



matt poliert
satin polished finish
acabado efecto satinado
poli mat effet satin

	Ø cm	↑ cm
00046	31	3



Torten- / Konditorplatte
cake stand
soporte para pastel
présentoir à gâteaux



Rand fixiert die Haube, mit Antirutsch-Füßchen
carved edge fixes the cover, non-slip feet
ranura para fijar bien la campana, pies antideslizantes
bord rainuré pour maintenir ferme la cloche, pieds antiglisse

	Ø cm	↑ cm	Farbe / Colour
00468	31	4	White
00469	31	4	Black



Kaviarkühler
caviar cooler
enfriador de caviar
rafraîchisseur de caviar



4-teilig: Glasschale Ø 10 cm
4 pcs.: glass bowl Ø 10 cm
4 piezas: bol Ø 10 cm
4 éléments: bol Ø 10 cm

	Ø cm	↑ cm
01699	18	12



Kühlschale, 2-teilig „COOL“
cool bowl, 2 pcs. set
cuenco refrigerado, 2 pz.
set de 2 bols réfrigérés



2-teilig, doppelwandig, Schale ist mit Kühlmittel gefüllt und wird zum Aufladen in das Gefrierfach gelegt, endlos verwendbar
2 pcs., 1 pc. double wall ice bowl filled with freezer-liquid, 1 pc. stainless bowl
bol isotérmico, doble pared que contiene un líquido refrigerante, acumula el frío en el congelador para luego mantener fríos los alimentos, para usos repetitivos
bol isotherme, double paroi qui contient un liquide réfrigérant, accumule le froid du congélateur pour ensuite maintenir froids les aliments, pour usages répétés

	Ø cm	↑ cm	litr.
30023	23	10,5	1

Deckel „FLOAT“ mit Löffelaussparung / cover, with notched for spoons / tapa, con espacio para la cuchara / couvercle, avec encoche pour la louche

	Ø cm	↑ cm
83920	20,5	1,3



30041

Edelstahlschale, doppelwandig

stainless bowl, double wall
bol inox doble pared
bol inox double paroi

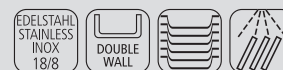

beste Isoliereigenschaften
best insulating properties
muy aislante
très isolant

	∅ cm	↑ cm	ltr.
30040	14	6,5	0,5
30041	20	9	1,5
30042	23	10	2,5



Teebrühsieb

snap mesh tea ball
infusor de té, pinza con malla
boule à thé avec pince



matt poliert, mit feinem Sieb, aufklappbar
satin polished finish, with fine mesh, hinged
acabado pulido efecto satinado, con malla fina, con bisagra
inox mat, maille fine, avec charnière

	∅ cm	→ cm
74750	4,5	15,5



Zitronenschnitzelpresse

lemon slice squeezer
pinza exprimelimon
pince presse citron



hochglanzpoliert, zum Auspressen von Zitronenscheiben
mirror polished finish, to press lemon slices
pulido brillante, para rodajas de limón
brillant, pour citrons en rondelle

	cm
71430	8 x 7



für ca. 30 Teebeutel
for approx. 30 teabags

Schale, 3-geteilt

bowl, 3-section
cuenco, 3 secciones
bol 3 compartiments



	cm	↑ cm
83536	17,5 x 7,5	4,5

Tabletop



Sauciere

gravy boat
salsera
saucière



hochglanzpoliert, extra schwere Qualität
mirror polished finish, high quality
acabado efecto espejo, alta calidad, base pesada
poli brillant, belle qualité, pied pesant

	cm	↑ cm	ltr.
40208	13 x 6	9,0	0,10
40204	16 x 7,5	9,0	0,15
40205	19 x 9,0	13,0	0,25
40206	22 x 10,5	13,5	0,45



Sauciere

gravy boat
salsera
saucière



poliert
polished
pulido
poli

	cm	↑ cm	ltr.
40200	14 x 6	7	0,10
40203	17 x 7,5	8,7	0,15
40201	22 x 9,5	10	0,20
40202	20 x 9	10,5	0,30



Thermo-Sauciere

insulated sauce boat
salsera isotérmica
saucière thermique



doppelwandig, Klappdeckelverschluss, Einhandbedienung
double wall, hinged cover, one-hand operation
doble pared, tapa con bisagra, se maneja con 1 mano
double paroi, couvercle avec charnière, usage 1 main

	cm	↑ cm	ltr.
40207	19 x 12,5	13	0,4



Gourmetlöffel, 6er Set

gourmet spoons, 6 pcs. set
 cucharas gourmet, set de 6 unidades
 cuillères gourmet, pack de 6



hochglanzpoliert, zur Präsentation von Vorspeisen
 mirror polished finish, perfect to present appetiser
 acabado brillante, perfecto para presentar aperitivos
 poli brillant, parfait pour les apéritifs et entrées

	cm	pcs.
00682	11 x 4	6



Gourmet-Löffel „CLASSIC“

party spoon
 cuchara gourmet
 cuillère gourmet



	→ cm		
00677	13,5	Edelstahl-Look / stainless steel look	
00691	12	Gold-Look / gold look	made from PVD coated stainless steel
00692	12	Kupfer-Look / copper look	made from PVD coated stainless steel



Glocke

cloche / dome cover
campana esférica
cloche demi-sphère

außen hochglanzpoliert, innen matt poliert, mit verchromten Griff

outside mirror polished finish, inside satin polished finish, with chromeplated handle
exterior pulido acabado efecto espejo, interior pulido acabado efecto satinado, pomo cromado
extérieur poli brillant, intérieur poli satin, buton chromé

	Ø cm	↑ cm
35734	29	18



Platzteller

plate tray
bajo plato
assiette de présentation



Rand eingerollt

rolled edge
borde redondeado
bord rond

	Ø cm	
35930	31	matt poliert / satin polished finish acabado efecto satinado / fini mat effet satin
35735	31	hochglanzpoliert / mirror polished pulido brillante / poli brillant



Platzteller

plate tray
bajo plato
assiette de présentation



hochglanzpoliert, mit Fadendekor

mirror polished finish, with line edge
pulido efecto espejo, con un filo en relieve
poli miroir, filet relief

	Ø cm
35730	30,5
36233	33,0



Platzteller

plate tray
bajo plato
assiette de présentation



hochglanzpoliert, mit Perlrand

mirror polished finish, with pearl edge
acabado pulido efecto espejo, con borde aperlado
poli miroir, bord perlé

	Ø cm
35720	30,5
36323	33



Untersetzer

coaster
posavasos
plateau sous-verre



hochglanzpoliert, schwere Ausführung, Rand eingerollt
mirror polished finish, heavy quality, rolled edge
acabado pulido efecto espejo, alta calidad, borde redondeado
effet miroir, bord rond, qualité extra

	Ø cm	pcs.
35711	10	6
35912	12	6



Serviettenringe, 6er Set

napkin rings, 6 pcs. set
servilleteros, set de 6
anneaux à serviettes, set de 6



	cm	↑ cm	pcs.
04445	6,5 x 4,5	1	6



Serviettenringe, 4er Set

napkin rings, 4 pcs. set
servilleteros, set de 4
anneaux porte-serviette, set de 4



	Ø cm	↑ cm	pcs.
04446	4,5	2,5	4



Messerbänkchen, 6er Set

knife rest, 6 pcs. set
reposa cuchillos, set de 6
repose-couteaux, set de 6



	cm	↑ cm	pcs.
04447	8 x 3	1,5	6

Tabletop



Topf darf nicht erhitzt werden!
Topf ist nicht zum Kochen geeignet!

Muscheltopf

mussel pot
mejillonera
casserole à moules

schwarz emailliertes Stahlblech, mit Edelstahlrand
black enameled steel, stainless steel rim
hierro esmaltado negro, borde inox
acier émaillé noir, bord inox



	Ø cm	↑ cm	litr.
00623	13,5	9	0,8
00625	18	12	2,0
00626	20	13	3,0
00627	24	13,5	4,0



40642



40643



40644

Stielkasserolle / Serviertopf

sauté pan / mini sauce pan
cazo recto bajo
plat à sauter



	Ø cm	↑ cm	litr.	
40642	5	3	0,07	Griff: 6 cm / handle: 6 cm asa: 6 cm / poignée: 6 cm
40643	7	4,5	0,14	Griff: 9 cm / handle: 9 cm asa: 9 cm / poignée: 9 cm
40644	9	6	0,36	Griff: 9 cm / handle: 9 cm asa: 9 cm / poignée: 9 cm



75002
Spieße
skewer

75001
Spießständer
skewer rack

Spießständer / Spieße

espetada and kebab skewer rack / skewer
soporte para brochetas
support pour brochettes

zum Servieren von Fleischspießen bis 40 cm, Gestell aus 8 mm Edelstahl
to serve skewers up to 40 cm, wire stainless steel 8 mm
para servir brochetas de carne hasta 40 cm, grosor del alambre 8 mm, inox
pour présenter les brochettes long. maxi 40 cm, fil 8 mm, inox



	Ø cm	↑ cm	
75001	22	46	
75002	0,3	40	4er Set / 4 pcs. set



Tisch-Set „VARIO I“

table set
set de mesa
set de table



4-teilig: 1 Ständer + 1 Behälter (innen Ø 7 cm) für Tischreste + 2 Behälter (innen Ø 9 cm) für Besteck, Servietten etc., vielseitig einsetzbar

4 pcs. set: 1 stand + 1 table garbage bin (inner Ø 7 cm) + 2 bins (inner Ø 9 cm) for cutlery, napkins etc., versatile applicable

4 piezas: 1 soporte + 1 papelera Ø 7 cm de sobremesa + 2 recipientes Ø 9 cm para cubiertos, servilletas etc.

4 éléments: 1 support + 1 poubelle de table Ø 7 cm + 2 récipients Ø 9 cm pour couverts, serviettes, etc.

	cm	↑ cm
11925	22 x 22	26

Einzel-Behälter / only container / sólo contenedor / récipient seul

	Ø cm	↑ cm
83998	13 / 7	14

Einzel-Behälter / only container / sólo contenedor / récipient seul

	Ø cm	↑ cm
83999	13 / 9	14



Tisch-Set „VARIO II“

table set
set de mesa
set de table



4-teilig: 1 Ständer + 3 Behälter (innen Ø 9 cm) für Besteck, Servietten etc., vielseitig einsetzbar

4 pcs. set: 1 stand + 3 bins (inner Ø 9 cm) for cutlery, napkins etc., versatile applicable

4 piezas: 1 soporte + 3 recipientes Ø 9 cm para cubiertos, servilletas etc.

4 pièces: 1 support, 3 récipients Ø 9 cm, pour couverts, serviettes,...

	cm	↑ cm
11927	22 x 22	26

Einzel-Behälter / only container / sólo contenedor / récipient seul

	Ø cm	↑ cm
83998	13 / 7	14

Einzel-Behälter / only container / sólo contenedor / récipient seul

	Ø cm	↑ cm
83999	13 / 9	14



Besteckköcher

cutlery basket
cesta para cubiertos
corbeille à couverts



	cm	↑ cm	Farbe / Colour
84535	12 x 12	16	White
84536	12 x 12	16	Dark Grey



Abtropflöcher
drainer holes

Tabletop



Besteckkorb „ECONOMIC“

cutlery dispenser
dispensador de cubiertos
corbeille à couverts



in Handarbeit geflochten
wickerwork
trensado a mano
tressage à main

	Ø cm	↑ cm	Farbe / Colour
40130	12	15	
40007	12	15	
40012 <small>NEW</small>	12	15	
40013 <small>NEW</small>	12	15	



Besteckkorb „ECONOMIC“

cutlery dispenser
dispensador de cubiertos
corbeille à couverts



in Handarbeit geflochten
wickerwork
trensado a mano
tressage à main

	cm	↑ cm	Farbe / Colour
40131	27 x 10	4,5	
40009	27 x 10	4,5	
40010 <small>NEW</small>	27 x 10	4,5	
40011 <small>NEW</small>	27 x 10	4,5	



Besteckkorb „ECONOMIC“

cutlery dispenser
dispensador de cubiertos
corbeille à couverts



	Ø cm	↑ cm
40286	12	15



Besteckkorb „ECONOMIC“

cutlery dispenser
dispensador de cubiertos
corbeille à couverts



	cm	↑ cm
40287	12 x 12	15



Table Caddy „COUNTRY STYLE“

table barrel
caddy de mesa
caddy de table



cooler Country-Style, nicht für den direkten Kontakt mit Lebensmittel verwendbar
make for cool condiment and cutlery holders or even for food presentation, the mini barrels should not come into contact with food, they should be lined with our greaseproof paper
estilo campo, no aptos para el contacto directo con alimentos, sólo usando papel alimenticio de style champêtre, pas de contact direct avec aliments, seulement en utilisant papier alimentaire

	Ø cm	↑ cm
11930	17,5	8,5
11931	11,5	14,0



Tischrestebehälter

table garbage bin
papelera de sobremesa
poubelle de table



matt poliert, abnehmbarer Schwingdeckel, mit Bajonettverschluss „fester Deckelsitz“
satin polished finish, swing cover, cover removable
acabado satinado, tapa basculante desmontable
poli mat satiné, couvercle basculant démontable

	Ø cm	↑ cm	ltr.
00053	14	20	2,0



Tischreste- / Besteckbehälter

table garbage bin / cutlery bin
papelera de sobremesa / recipiente para cubiertos
poubelle de table / récipients pour couverts



matt poliert, mit abnehmbarem Lochdeckel
satin polished finish, with removeable cover
acabado pulido satinado, con tapa desmontable
poli mat satiné, avec couvercle démontable ouvert au centre

	Ø cm	↑ cm	ltr.
00028	10	12	0,7



Tischrestebehälter

table garbage bin
papelera de sobremesa
poubelle de table



matt poliert, abnehmbarer Schwingdeckel, mit Bajonettverschluss „fester Deckelsitz“
satin polished finish, swing cover, cover removable
acabado satinado, tapa basculante desmontable
poli mat satiné, couvercle basculant démontable

	Ø cm	↑ cm	ltr.
00029	12	17	1,2
00027	10	13	0,7

Tabletop



Tischreste- / Besteckbehälter / Universalbox
 table waste bin / cutlery bin / box
 papelera de sobremesa / recipiente para cubiertos
 poubelle de table / récipients pour couverts



mit verchromten Rand, stapelbar
 with chrome plated ring, stackable
 con anillo cromado, apilables
 avec bord chromé, empilable

	cm	↑ cm	Farbe / Colour
00015	13,5 x 13,5	11	■
00215	13,5 x 13,5	11	■



stapelbar
 stackable
 apilables
 empilable



Tischreste- / Besteckbehälter
 table waste bin / cutlery bin
 papelera de sobremesa / recipiente para cubiertos
 poubelle de table / récipients pour couverts



mit verchromten Rand, inkl. herausnehmbarem Einteiler (4 Fächer)
 with chrome plated ring, incl. divider (4 chambers)
 con anillo cromado
 avec bord chromé

	cm	↑ cm	Farbe / Colour
00016	14 x 14	16	■
00216	14 x 14	16	■



Tischrestebehälter „SUNDAY“

table waste bin
 papelera de sobremesa
 poubelle de table



matt poliert, inkl. Deckel, fester Deckelsitz
 satin polished finish, incl. cover, cover removeable
 acero inoxidable mate, con tapa
 inox mat, avec couvercle

	Ø cm	↑ cm	ltr.
00024	10	18	1,1



Tischrestebehälter
 table garbage bin
 papelera de sobremesa
 poubelle de table



Behälter aus weiß lackiertem Metall, Edelstahl-Lochdeckel
 metall white, stainless cover with hole
 tapa, acero inoxidable, con apertura
 couvercle inox, avec ouverture centrale, récipient en acier laqué blanc

	Ø cm	↑ cm	ltr.
00292	12	15	1,2



Tischrestebehälter

table garbage bin
papelera de sobremesa
poubelle de table



Behälter aus weiß lackiertem Metall, abnehmbarer Schwingdeckel

cover stainless steel bin metal, white, swing cover
tapa de acero inoxidable, recipiente chapa lacada blanca
couverture inox basculant, récipient en acier laqué blanc

	Ø cm	↑ cm	litr.
00291	12	17	1,2



Tischrestebehälter „INTERNATIONAL“

table waste bin
papelera de sobremesa
poubelle de table



Deckel-Ring mit Dichtung, internationale Beschriftung

cover with sealing ring
tapa con junta, texto multi-idomas
couverture avec joint, texte multilingue

	Ø cm	↑ cm	litr.
83847	10	17,5	1



Tischrestebehälter

table garage bin
papelera de sobremesa
poubelle de table



	Ø cm	↑ cm	litr.	Farbe / Colour
02038	11	14	0,9	
02039 <small>NEW</small>	11	14	0,9	



Tischrestebehälter

table garbage bin
papelera de sobremesa
poubelle de table



	Ø cm	↑ cm	litr.
00311	14	15	1,2



Tischrestebehälter

table garbage bin
papelera de sobremesa
poubelle de table



Kunststoff weiß / granit, abnehmbarer Schwingdeckel

white plastic, swing cover, cover removable
plástico blanco/granito, tapa basculante desmontable
plastique blanc/gris chiné, couvercle basculant démontable

	Ø cm	↑ cm	litr.
00031	12	18	1,4



Besteckbehälter „ELEMENT“

cutlery bin
recipiente para cubiertos
récipients pour couverts



mit Abflussloch, mit Besteck Logo, Bodeneinlagen aus Silikon zum Schonen der Messerspitzen, möbelschonende Unterseite
with drain hole, with cutlery logo, silicone floor inserts for saving the points of knives, with non-scratching undersurface
con orificio de drenaje, con logotipo de cubertería, soporte de silicona para proteger las puntas de los cuchillos, con base antirrayaduras
avec le trou de drainage, avec le logo de coutellerie, insert de silicone pour protéger les pointes des couteaux, avec base revêtue antirayures

	Ø cm	↑ cm
00018	11	14



Tischreste- / Besteckbehälter „TOP CHROME“

table waste bin / cutlery bin
papelera de sobremesa / recipiente para cubiertos
poubelle de table / récipients pour couverts



mit verchromten Rand
with chrome plated ring
con anillo cromado
avec bord chromé

	Ø cm	↑ cm	ltr.	Farbe / Colour
00025	13	15	1	White
00026	13	15	1	Black



Tischreste- / Besteckbehälter „BASE CHROME“

table waste bin / cutlery bin
papelera de sobremesa / recipiente para cubiertos
poubelle de table / récipients pour couverts



mit verchromten Boden
with chrome bottom
con base cromada
avec base chromée

	Ø cm	↑ cm	ltr.	Farbe / Colour
00019	13	15	1,3	White
00020	13	15	1,3	Black



Besteckköcher

cutlery basket
cesta para cubiertos
corbeille à couverts



	Ø cm	↑ cm	
11998	9,7	13,7	Kunststoff weiß / white plastic plástico blanco / plastique blanc
11999	9,7	13,7	matt poliert / satin polished finish acero inoxidable / inox

11998
Köcher weiß

11999
Köcher Edelstahl



Besteckständer
cutlery basket
cesta para cubiertos
égouttoir à couverts

matt poliert
satin polished finish
inox mate (sin cubiertos)
inox mat



	Ø cm	↑ cm
11923	12,5	15,5



11921

11922

Besteckständer
cutlery basket
cesta para cubiertos
égouttoir à couverts

matt poliert
satin polished finish
inox mate (sin cubiertos)
inox mat



	Ø cm	↑ cm
11921	10	10,0
11922	12	13,5



Tischkrümelentferner
crumber
recogemigas
ramasse-miettes

matt poliert, Hohlgriff
satin polished finish, hollow handles
acabado mate, fácil de usar, mango hueco
mat satiné, manche creux, simple à utiliser



	cm	→ cm
00058	6,5 x 2,5	22



Tischkrümelentferner
crumber
recogemigas
ramasse-miettes

matt poliert, geschliffene Edelstahlkante lässt kein Körnchen zurück
satin polished finish, no grain remains thanks to the flat grinded stainless steel edge
acabado pulido mate, las migas se recogen fácilmente del mantel sin dejar restos gracias a su borde afilado
mat satiné, ramasse facilement les miettes sur la nappe sans rien laisser grâce au rebord affilé



	cm	↑ cm
00581	19 x 4,5	1



Kreide-Marker, Stärke 2mm, 2er Set

chalk marker, 2 pcs.
rotulador de tiza, 2 pz.
marqueur a la craie liquide, 2 pc.



Zum Gestalten und Beschriften von Tafeln, Glas und fast allen geschlossenen Oberflächen, deckende Flüssigkreide auf Wasserbasis, feucht abwischbar

For decorating and writing on boards, glass and almost all non-porous surfaces, opaque water-based liquid chalk, wet-wipeable
Rotuladores para pizarra de tiza líquida para decorar y escribir sobre pizarras, cristales y casi todas las superficies no porosas. Tizi líquida opaca al agua que se pueda borrar con un trapo
Pour décorations et inscriptions sur tableaux, verre et presque toutes les surfaces non poreuses, craie liquide opaque à base d'eau, effaçable avec un chiffon humide

	Ø cm	↑ cm	Farbe / Colour	pcs.
71490	1	13	White	2
71491	1	13	Black	2



Kartenhalter, 2er Set „KLAMMER“

table stand, 2 pcs. set
set de 2 piezas, soporte de mesa
set de 2 pièces, support de table



inkl. 30 Beschriftungskarten (15 x weiß, 15 x schwarz- ca. 10 x 8 cm)
incl. 30 cards (15 x white, 15 x black - 10 x 8 cm)
incluye 30 tarjetas (15 x blanco, 15 x negro - 10 x 8 cm)
includ 30 étiquettes (15 x blanc, 15 x noir - 10 x 8 cm)

	cm	↑ cm	Farbe / Colour
71487	4 x 2,5	10	Gold
71488	4 x 2,5	10	White
71489	4 x 2,5	10	Black

Beschriftungskarten, 50 Stück / designation cards, 50 pcs. set
cartelitos de designación, 50 piezas / cartes de désignation, 50 pièces

	cm	Farbe / Colour	fits to
71498	10 x 8	White	71487, 71488, 71489
71499	10 x 8	Black	71487, 71488, 71489



Beschriftungsetiketten

labeling labels
etiquetas
étiquettes



12 Bögen mit je 6 Motiven, selbstklebend, mit wasserlöslichem Stift beschreibbar
12 sheets includes 6 self-adhesive and removable labels, use regular chalkboard markers and wipe clean with a damp cloth
12 hojas, cada una con 6 motivos autoadhesivos, se pueden marcar con un rotulador lavable con agua
12 feuilles chacune avec 6 motifs autoadhésifs, on peut écrire avec un stylo lavable à l'eau

	cm	Farbe / Colour
00069	8,0 x 4,6	Black





10 Schilderhalter „FLEX CLIP“

10 sign holders
set de 10 clips
set de 10 porte-étiquettes



Durch die bewegliche Verbindung der Klemme und Schilderhalterung ein extrem flexibler Cliphalter!

multi angle ticket clip
inclinable con pinza
inclinable avec pince

	→ cm	Farbe / Colour
71472	9,5	White
71474	9,5	Black

Schilder, 10er Set / signs, 10 pcs. set / set de 10 cartelitos / set de 10 étiquettes

	cm	pcs.
11879	7,7 x 5,2	10
12879	5,0 x 3,0	10



Tischnummernschild

table numbers
números para mesa
numéros de table



matt poliert, Zahlen aus schwarzem Siebdruck, Materialstärke 0,8 mm, schwere Qualität, VE: 12 aufeinanderfolgende Zahlen, nicht einzeln lieferbar
satin polished finish, numbers black screenprint, material 0,8 mm thick, heavy gauge, unit: set of 12 numbers only
pulido satinado, números serigrafiados en negro, grosor del acero 0,8 mm serigrafía no apta para lavavajillas, set 12 números seguidos
mat satiné, numéros sérigraphés en noir (non-résistants au lave-vaisselle), épaisseur 0,8 mm, 12 numéros consécutifs

	cm	pcs.	
71450	5,3 x 4,5	12	1-12
71451	5,3 x 4,5	12	13-24
71452	5,3 x 4,5	12	25-36
71453	5,3 x 4,5	12	37-48
71454	5,3 x 4,5	12	49-60
71455	5,3 x 4,5	12	61-72



2 Tischaufsteller

2 table stands
2 caballetes de mesa
2 chevalets de table



	cm	↑ cm	
00017	5,5 x 5	3,5	reserviert
00013	5,5 x 5	3,5	reserved
00572	5,5 x 5	3,5	
00573	5,5 x 5	3,5	



Tafelhalter / Schild

slate sign
caballete de mesa, pizarra
plaque signalétique avec support

SCHIEFER
SLATE

	cm	↑ cm
00060	12 x 4	7



10 Beschriftungsclips, inkl. 10 Schilder

10 sign holders, with 10 signs
10 soportes + 10 cartelitos
10 supports + 10 étiquettes

PVC KUNSTSTOFF PP POLYPROPYLEN

	cm	Farbe / Colour
71482	6 x 2,7	
71483	6 x 2,7	

Schilder, 10er Set / signs, 10 pcs. set / set de 10 cartelitos / set de 10 étiquettes

	cm
11879	7,7 x 5,2
12879	5,0 x 3,0



Schilderhalter „FLEXIBEL“

sign holder
soporte para cartelito
support pour menu de table

METALL VERCHROMT EDELSTAHL STAINLESS INOX

biegsamer Draht mit zwei Klemmen, extrem flexibel, die Klemmen lassen sich weit öffnen
bedable metal coil adds visual interest, two metal clip open
metal cromado flexible, 2 pinzas con gran apertura
métal chromé, flexible, 2 pinces à grande ouverture

	→ cm	
71470	12	ohne Schilder / without signs sin cartelitos / sans étiquette
71471	23	ohne Schilder / without signs sin cartelitos / sans étiquette
71480	12	inkl. 10 Schilder 11879 / incl. 10 signs 11879 con 10 cartelitos 11879 / avec 10 étiquettes 11879

Schilder, 10er Set / signs, 10 pcs. set / set de 10 cartelitos / set de 10 étiquettes

	cm
11879	7,7 x 5,2
12879	5,0 x 3,0



Kartenhalter „WÜRFEL“, 4er Set

table stands, 4 pcs. set
soporte de mesa, 4 piezas
set de 4 porte-étiquettes

ACRYL
ACRYLIC

inkl. 20 weiße Beschriftungskarten, mehrfach beschriftbar
incl. 20 white labels
incluye 20 etiquetas blancas
20 étiquettes blanches incluses

	cm	pcs.
00078	3 x 3 x 3	4



Kartenhalter „ZYLINDER“, 4er Set

table stands, 4 pcs. set
soporte de mesa, 4 piezas
set de 4 porte-étiquettes

ACRYL
ACRYLIC

inkl. 20 weiße Beschriftungskarten, mehrfach beschriftbar
incl. 20 white labels
incluye 20 etiquetas blancas
20 étiquettes blanches incluses

	cm	pcs.
00079	3 x 3 x 3	4



6 Stck. Halter
12 Stck. Karten

Kartenhalter-Set

card holder set
set de porta cartelitos
set complet supports + étiquettes

PP
POLYPROPYLEN
METALL
VERCHROMT

18-teilig: 6 Kartenhalter 4 x 2,5 cm + 12 Kunststoff-Beschriftungskarten 10 x 5,7 cm
18 pcs. set: 6 card holder 4 x 2,5 cm + 12 plastic cards of inscription 10 x 5,7 cm
set de 18 piezas: 6 soportes cromados 4 x 2,5 cm + 12 carteles para inscripción, 10 x 5,7 cm
set de 18 pièces: 6 supports chromés 4 x 2,5 cm + 12 panneaux 10 x 5,7 cm

	cm
00022	4 x 2,5



Beschriftungskarten, 10er Set

designation cards, 10 pcs. set
cartelitos de designación, 10 piezas
cartes de désignation, 10 pièces

PVC
KUNSTSTOFF

	cm	*mm
00037	7,5 x 5	0,4

Tabletop



Tischkartenhalter

table stand
soporte de mesa
support de table



möbelschonende Unterseite
non-scratching undersurface
con base antirrayaduras
avec base revêtue antirayures

	cm	↑ cm
00071	14 x 5,5	14



Tischkartenhalter „PROFI“

table stand
soporte de mesa
support de table



	cm	↑ cm
40425	9,5 x 7,5	13,5



Tischkartenhalter

table stand
soporte-carta para la mesa
support pour menu de table



matt poliert
satin polished finish
pulido satinado
poli mat satiné

	cm	↑ cm
00030	8,0 x 7,0	2
00036	6,1 x 4,5	4



Kartenhalter, 2er Set

menu holder, 2 pcs. set
porta cartas de mesa, set 2 piezas
set de 2 supports pour menu de table



	cm	↑ cm	pcs.
00023	8,5 x 6	4,5 / 8,5	2



Kartenhalter, 2er Set
 menu holder, 2 pcs. set
 porta cartas de mesa, set 2 piezas
 set de 2 porte-menus de table



matt poliert
 satin polished finish
 pulido acabado en mate
 mate

	cm	↑ cm	pcs.
00021	8,5 x 4	4 / 8,5	2

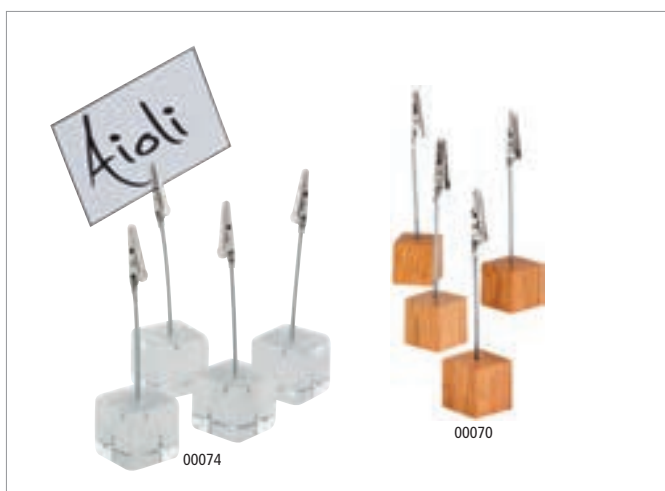

Kartenhalter, 4er Set
 table stands, 4 pcs. set
 set 4 piezas soportes de mesa
 set de 4, support de table



inkl. 20 weiÙe Beschriftungskarten
 incl. 20 white labels
 incluye 20 etiquetas blancas
 20 étiquettes blanches incluses

	cm	↑ cm	pcs.	Farbe / Colour
00074	3 x 3	12	4	
00700	2,5 x 2,5	12	4	



Bankettkartenständer
 menu stand / table number
 porta-etiqueta o carta de sobremesa
 porte-étiquette de table, porte-menu, ou n° de table



hochglanzpoliert, schwere Qualität
 mirror polished finish, heavy gauge
 acero inoxidable de alta calidad
 inox, belle qualité

	Ø cm	↑ cm
71460	7,5	18,5
71461	7,5	29
71462	7,5	46



Speisekartenhüllen, 3er Set
 menu cover, 3 pcs. set
 funda para cartas de menu, set 3 piezas
 protège-menu, le pack de 3



einseitig offen, glasklarer Kunststoff, Lieferung ohne Halter
 open at one side, clear plastic, delivery without table stand
 apertura por un lado, plástico transparente, se entrega sin soporte de sobremesa
 ouverture sur un côté, plastique transparent, livraison sans support de table

	cm	pcs.
00362	16,5 x 11,5	3
00363	20,0 x 12,0	3



NEW

Tischaufsteller, 10er Set

table stands, 10 pcs. set
caballes de mesa, set de 10 pz.
chevalets de table, set de 10 pc.



Ecken abgerundet
corners rounded
esquinas redondeadas
coins arrondies

	cm	↑ cm	pcs.
00011	7,5 x 3,5	5	10
00012	10,5 x 6	6,5	10



Kartenhalter, 2er Set

card holder, 2 pcs. set
set de 2 piezas, soporte de mesa
set de 2 pièces, support de table



inkl. 40 Beschriftungskarten, durch Magnete einfach zusammenklappbar
incl. 40 cards, easily foldable with magnets
incluye 40 tarjetas, fácil de plegar, con imanes
includ 40 étiquettes, fácil à plier, avec aimants

	cm	pcs.
00076	9 x 3 x 5,5	2



Tischkartenhalter, 4er Set

table stands, 4 pcs. set
set de 4 pinzas porta-etiquetas
pack de 4 porte-étiquettes à pince



hochglanzpoliert, schwerer Fuß, inkl. 20 weiße Beschriftungskarten
mirror polished finish, heavy food, incl. 20 white labels
acabado brillante, incluye 20 etiquetas en blanco
poli brillant, includ 20 étiquettes blanches

	Ø cm	↑ cm	pcs.
00070	4	10	4



03610

Buffetschilder, 3er Set

buffet signs, 3 pcs. set
set de 3 piezas indicadores bufé
set de 3 petits chevalets de buffet



können mit einem wasserfesten Filzschreiber beschrieben werden
can be marked with water-based felt markers
pueden marcarse con rotuladores de agua
écriture facile avec un feutre lavable à l'eau

	cm	↑ cm
03610	12,0 x 6,0	6,0
03611	16,0 x 8,5	8,5



00937

Naturschieferplatte „STARTER“

natural slate tray
bandeja de pizarra natural
plat ardoise naturelle carré



	cm	* mm
00937	20 x 10	6 - 9
00938	30 x 10	6 - 9
00939	30 x 15	6 - 9



Weck-Glas 82316



Naturschieferplatte / Untersetzer

natural slate tray
bandeja de pizarra natural
plateau ardoise naturelle



mit 2 Absätzen Ø 6 cm
with 2 holes Ø 6 cm
con 2 agujeros Ø 6 cm
avec 2 trous Ø 6 cm

	cm	* mm
00971	15 x 8	6 - 9



00935

2er Set / 2 pcs. set

Naturschieferplatte, 2er Set

natural slate tray, 2 pcs.
bandeja de pizarra natural, 2 pz.
plat ardoise naturelle, 2 pc.



mit Safrinne
with juice groove
con canal de jugo
avec canal de jus

	Ø cm	* mm	pcs.
00935	23	6 - 9	2

	cm	* mm	pcs.
00936	26 x 20	6 - 9	2



Naturschieferplatte

natural slate tray
bandeja de pizarra natural
plat ardoise naturelle



	cm	* mm
00996	45 x 30	6 - 9



00994

Naturschieferplatte

natural slate tray
bandeja de pizarra natural
plat ardoise naturelle



	cm	* mm
00994	25 x 25	6 - 9
00995	30 x 30	6 - 9

Gewürzmühlen Professional



Die Salz-/Pfeffermühlen werden aus deutschem Buchenholz gefertigt und sind durch S=Salz / P=Pfeffer an der Justierschraube einfach gekennzeichnet. Die Pfeffermühlen haben ein Mahlwerk aus Carbon – scharfes und langlebiges Mahlwerk (Rockwellhärte 55) – Pfefferkörner werden erst „geschält“ anschließend „fein gemahlen“. Das Mahlwerk der Salzmühle eignet sich zum Mahlen von grobem und trockenem Meersalz. Das Carbonstahl-Mahlwerk ist beständig gegen Korrosion.

The salt and pepper mills are made of German beech wood and marked by S = salt / P = pepper on the adjustment knob. The pepper mills have a grinder of carbon – a sharp and very durable grinder (Rockwell hardness 55) - pepper grains are first „peeled“ then „finely grounded“. The grinder of the salt mill is suitable for grinding coarse and dry sea salt. The carbon steel grinder is resistant to corrosion.

Los molinos de sal/pimienta están hechos de madera de haya alemana y simplemente caracterizados por S = sal / P = pimienta en el tornillo de ajuste. Los molinos de pimienta tienen un mecanismo de trituración de carbono – una amoladora aguda y durable (dureza Rockwell 55) - los granos de pimienta son solamente „pelados“ y luego „finamente molidos“. La amoladora del molino de sal es adecuado para la molienda de la sal de mar gruesa y seca. El mecanismo de trituración de acero al carbono es resistente a la corrosión.

Les moulins de sel / poivre sont fabriquées en bois de hêtre allemand et seulement caractérisé par S = sel / P = poivre sur la vis de réglage. Les moulins à poivre ont un mécanisme de broyage de carbone – un broyeur fort et durable (dureté Rockwell 55) - les grains de poivre sont seulement « pelées », puis « finement broyé ». Le broyeur du moulin à sel est adapté pour le broyage de sel de mer grossier et sec. Le mécanisme de broyage en acier au carbone est résistant à la corrosion.

Mahlgrad einstellen:

feines Mahlen: Schraube im Uhrzeigersinn drehen
 grobes Mahlen: Schraube entgegen dem Uhrzeigersinn drehen

Adjustment knob

Turn knob clockwise for finer grind, counter clockwise for coarser grind

Bouton d'ajustement

tourner le bouton dans le sens antihoraire pour une mouture plus grosse

Bouton d'ajustement

tourner le bouton dans le sens antihoraire pour une mouture plus grosse



Schaft: Aus korrosionsfestem Edelstahl

Shaft: corrosion resistant stainless steel

Tige: en acier inoxydable

Tige: en acier inoxydable

Federmechanismus:

gewährleistet ein konstantes Mahlergebnis

Spring loaded mechanism:

ensures a consistent grind selection

mechanisme à ressort:

assure une mouture homogène

mechanisme à ressort:

assure une mouture homogène

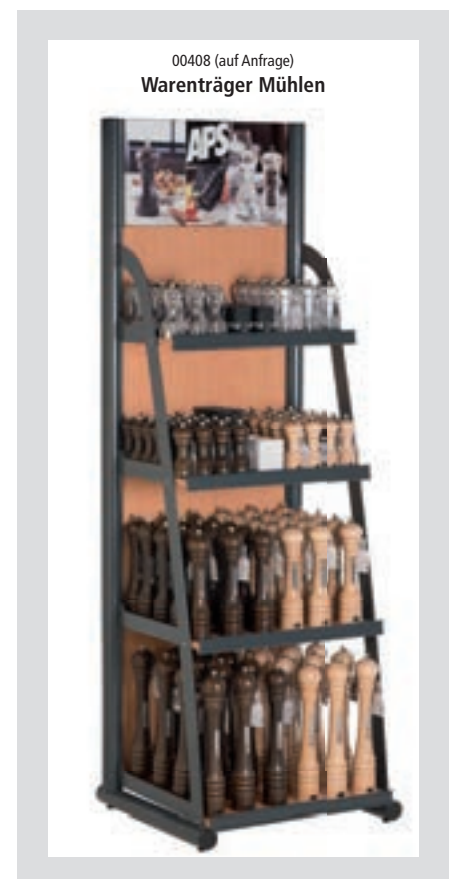



Pfeffermühle „PROFESSIONAL“

pepper mill
molinillo de pimienta
moulin à poivre

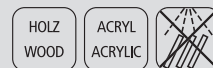

	Ø cm	↑ cm	Farbe / Colour
40540	5,5	15	Acryl / acrylic
40530	5,5	15	Holz / wood
40532	7	30	Holz / wood
40534	7	40	Holz / wood
40520	5,5	15	Holz / wood
40522	7	30	Holz / wood
40524	7	40	Holz / wood



Salzmühle „PROFESSIONAL“

salt mill
molinillo de sal
moulin à sel



	Ø cm	↑ cm	Farbe / Colour
40541	5,5	15	Acryl / acrylic
40531	5,5	15	Holz / wood
40521	5,5	15	Holz / wood



Tablett

tray
bandeja
plateau



mit 2 Absätzen Ø 6 cm
with 2 holes Ø 6 cm
con 2 agujeros Ø 6 cm
avec 2 trous Ø 6 cm

	cm	↑ cm
84039	16,5 x 8,5	1,5



Naturschieferplatte / Untersetzer

natural slate tray
bandeja de pizarra natural
plateau ardoise naturelle



mit 2 Absätzen Ø 6 cm
with 2 holes Ø 6 cm
con 2 agujeros Ø 6 cm
avec 2 trous Ø 6 cm

	cm	* mm
00971	15 x 8	6 - 9



Pfeffermühle „PROFESSIONAL VINTAGE“

pepper mill
molinillo de pimienta
moulin à poivre



Deutsches Buchenholz, vintage, Mahlwerk aus Carbonstahl, Mahlgrad stufenlos einstellbar
German beechwood, vintage, mill in carbon steel, the grinding degree can be adjusted infinitely

madera de haya alemana, carácter „vintage“, molinillo de acero al carbono, el grado de moli-
no se puede ajustar de modo continuo
bois de hêtre d'Allemagne, vintage, moulin en acier de carbone, la finesse de mouture se peut
réglée de façon continue

	Ø cm	↑ cm	Farbe / Colour
40535	5,5	15	
40537	6	23	
40546	5,5	15	
40548	6	23	



Salzmühle „PROFESSIONAL VINTAGE“

salt mill
molinillo de sal
moulin à sel



Deutsches Buchenholz, vintage, Mahlwerk aus Edelstahl, Mahlgrad stufenlos einstellbar
German beechwood, vintage, mill in stainless steel, the grinding degree can be adjusted infinitely

madera de haya alemana, carácter „vintage“, molinillo de acero inoxidable, el grado de moli-
no se puede ajustar de modo continuo
bois de hêtre d'Allemagne, vintage, moulin en acier inoxydable, la finesse de mouture se peut
réglée de façon continue

	Ø cm	↑ cm	Farbe / Colour
40536	5,5	15	
40547	5,5	15	



Chilimühle

chili mill
molinillo de chile
moulin à piment



	Ø cm	↑ cm
40542	4,5	18,5



2 in 1 Salz- u. Pfeffermühle

2 in 1 salt / pepper mill
2 in 1 molinillo de sal / pimienta
2 in 1 moulin à sel / poivre



Keramik Mahlwerk
ceramic mechanism
molinillo de cerámica
broyeur en céramique

	Ø cm	↑ cm
40545	7,5	18,5



Mahlgrad einstellbar
grinder setting

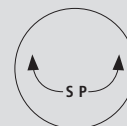



Pfeffermühle „ELEMENT“

pepper mill
molinillo de pimienta
moulin à poivre

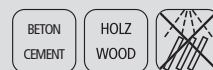

Mahlwerk aus Carbonstahl, Mahlgrad stufenlos einstellbar
mill in carbon steel, the grinding degree can be adjusted infinitely
molinillo de acero al carbono, el grado de molino se puede ajustar de modo continuo
moulin en acier de carbone, la finesse de mouture se peut réglée de façon continue

	Ø cm	↑ cm
40538	6	18



Salzmühle „ELEMENT“

salt mill
molinillo de sal
moulin à sel



Mahlwerk aus Edelstahl, Mahlgrad stufenlos einstellbar
mill in stainless steel, the grinding degree can be adjusted infinitely
molinillo de acero inoxidable, el grado de molino se puede ajustar de modo continuo
moulin en acier inoxydable, la finesse de mouture se peut réglée de façon continue

	Ø cm	↑ cm
40539	6	18



2 in 1 Salz- u. Pfeffermühle

2 in 1 salt / pepper mill
2 in 1 molinillo de sal / pimienta
2 in 1 moulin à poivre / sel



Keramik-Mahlwerk
ceramic mechanism
molinillo de cerámica
broyeur en céramique

	cm	↑ cm
40544	6 x 4,5	9,5



Mahlgrad einstellbar
grinder setting

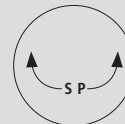

2 in 1 Salz- u. Pfeffermühle

2 in 1 salt / pepper mill
2 in 1 molinillo de sal / pimienta
2 in 1 moulin à poivre / sel



	cm	↑ cm
40543	6 x 5	8

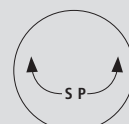



Käse- oder Gewürzstreuer

spice shaker
botes especieros
saupoudreuse à épices



Löcher Ø 5,5 mm, inkl. Staubdeckel
holes Ø 5,5 mm, incl. cover
agujeros Ø 5,5 mm, tapa plástico
trous Ø 5,5 mm, couvercle plastique

	Ø cm	↑ cm	ltr.	
00775	5,5	7,5	0,15	Ø Löcher 1,5 mm



Netzstreuer

mesh top shaker
polvoreador, tapa con malla fina
pot à épices, couvercle toile fine



inkl. Staubdeckel
incl. cover
tapa plástico
couvercle plastique

	Ø cm	↑ cm	ltr.
00776	5,5	7,5	0,15



Streuer fein

small hole shaker
polvoreador, tapa con agujeros pequeños
pot à épices, couvercle à petits trous



Löcher Ø 1 mm, inkl. Staubdeckel
holes Ø 1 mm, incl. cover
agujeros Ø 1 mm + tapa plástico
trous Ø 1 mm + couvercle plastique

	Ø cm	↑ cm	ltr.	
00777	5,5	7,5	0,15	Ø Löcher 1,5 mm



Streuer grob

large hole shaker
polvoreador, tapa con agujeros grandes
pot à épices, couvercle à grands trous



Löcher Ø 2,5 mm, inkl. Staubdeckel
holes Ø 2,5 mm, incl. cover
agujeros Ø 2,5 mm + tapa plástico
trous Ø 2,5 mm + couvercle plastique

	Ø cm	↑ cm	ltr.	
00778	5,5	7,5	0,15	Ø Löcher 2,5 mm



Multistreuer
 multi-functional shaker
 salero
 saupoudreuse



	Ø cm	↑ cm	ltr.
00774	7	12	0,20



geschlossen Ø 2 mm Ø 4 mm Ø 6 mm



Multistreuer
 multi-functional shaker
 salero
 saupoudreuse



	Ø cm	↑ cm	ltr.
00773	6	8	0,05



geschlossen Ø 2 mm Ø 4 mm Ø 6 mm



Netzstreuer
 mesh top shaker
 polvoreador, tapa con malla fina
 pot à épices, couvercle toile fine



	Ø cm	↑ cm	ltr.
00781	6,5	12	0,20



Multistreuer / Gewürzstreuer
 multi-functional shaker
 juego dosificador
 jeu de salières



	Ø cm	↑ cm	ltr.	
00782	6,5	12	0,20	
00783	6,5	12	0,20	mit 8 Löchern / with 8 holes con 8 agujeros / avec 8 trous



00782 - Ø 2 mm 00783 - Ø 8 mm

Tabletop



Salz- und Pfefferstreuer, 2er Set

salt - and pepper shaker, 2 pcs. set
juego de 2 piezas de sal y pimienta
set sel et poivre, 2 pz.



	Ø cm	↑ cm	pcs.	
40500	5	6,5	2	glatte Ausführung / smooth version versión recta / forme lisse
40501	5	6,5	2	geriffelte Ausführung / fluted version versión ondulada / forme ondulée
40507	6	10	2	



Allzweckstreuer, 12er Set

shaker, 12 pcs set
juego 12 piezas dosificador
jeu de 12 salières/poivrières



	cm	↑ cm	pcs.	
40504	4 x 4	10	12	13 Löcher / 13 holes 13 agujeros / 13 trous
40505	4 x 4	10	12	3 Löcher / 3 holes 3 agujeros / 3 trous



Ministreuer, 4er Set

smaller shaker, 4 pcs. Set
juego de 4 piezas bodegas pequeñas
jeu de 4 mini-salières



	Ø cm	↑ cm	pcs.
40503	3,5	4	4



Salzstreuer

salt shaker
salero
salière



Pommes-Frites Streuer mit Schraubkappe
for french fries, cover to screw
para patatas fritas, tapa de rosca
pour les frites, couvercle à visser

	Ø cm	↑ cm	
00779	8	17	Aluminium / aluminium aluminio / aluminium
00772	8	17	Edelstahl / stainless steel acero inoxidable / inox



Pfeffer- & Salz-Menage „WOOD“

salt- and pepper-menage
salero-pimentero
ménage sel et poivre



matt poliert, Glasbehälter mit Edelstahl-Deckel und Deckelverschluss
satin polished finish, glass with stainless steel cover
pulido acabado efecto satinado, cristal con tapa de acero inoxidable
verre et inox mat satiné

	cm	↑ cm
40435	11,5 x 5,5	17



Essig- & Öl-Menage „WOOD“

oil- and vinegar-menage
aceitera-vinagrera
ménage huile et vinaigre



matt poliert, Glasbehälter mit Edelstahl-Deckel und Drehverschluss
satin polished finish, glass with stainless steel cover
pulido acabado efecto satinado, con tapa de acero inoxidable
verre et inox mat satiné

	cm	↑ cm
40436	16 x 7,5	24,5



Pfeffer-, Salz-, Essig- und Öl-Menage „WOOD“

salt- and pepper- and oil- and vinegar-menage
salero-pimentero & aceitera-vinagrera
ménage sel et poivre & huile et vinaigre



mattiert, möbelschonende Unterseite
satin polished finish, glass with stainless steel cover
pulido acabado efecto satinado, con tapa de acero inoxidable
verre et inox mat satiné, avec couvercle inox

	cm	↑ cm
40437	15,5 x 12	24,5

Salz- und Pfefferstreuer / salt - and pepper shaker / juego de sal y pimienta / set sel et poivre

	Ø cm	↑ cm	
40438	4	9	6 Löcher - Ø 1,85 mm
40439	4	9	18 Löcher - Ø 1,35 mm

Ersatzglas Essig / Öl / spare glass vinegar / oil / cristal de recambio con tapa „aceite & vinagre“
verre huile ou vinagre

	Ø cm	↑ cm	ltr.
40442	6	18,5	0,2



praktischer Ausgießer
no drips pourer



Menage „ECONOMIC“

menage
menage
ménage



Glasbehälter mit Edelstahl-Deckel und Drehverschluss

glass with stainless steel cover
cristal con tapa inox a rosca
en verre avec couvercle inox à visser

	cm	↑ cm
40455	8 x 4	13



Menage „ECONOMIC“

menage
menage
ménage



Glasbehälter mit Edelstahl-Deckel und Drehverschluss

glass with stainless steel cover
cristal con tapa inox a rosca
en verre avec couvercle inox à visser

	cm	↑ cm
40457	8 x 8	12

Glas für Senf / glass for mustard / vaso de cristal para mostaza / pot verre seul pour la moutarde

40464



Menage „ECONOMIC“

menage
menage
ménage



Glasbehälter mit Edelstahl-Deckel und tropffreiem Kunststoff-Ausgießer

glasses with stainless steel cover and non-drip nozzle-spout
cristales con tapa de acero inoxidable y sistema antigoteo
en verre avec couvercle inox et insert plastique antigoutte

	cm	↑ cm
40458	11,5 x 5,5	22
40460	11 x 10,5	22

Pfeffer- oder Salz-Glasstreuer / pepper- or salt-glass with cover salero o pimentero de cristal con tapa / salière ou poivrière seule en verre avec couvercle inox

	Ø cm
40461	14

Essig- oder Öl-Glasbehälter / oil- or vinegar-glass with cover / aceitera-vinagrera con tapa bouteille huile ou vinaigre seule en verre et couv. inox

	Ø cm
40462	14

Glas für Zahnstocher / glass for tooth picks / vaso de cristal para palillos de dientes

	Ø cm
40463	14



Pfeffer- & Salz-Menage „CLASSIC“

salt- and pepper-menage
salero-pimentero
ménage sel et poivre



Glasbehälter mit Edelstahl-Deckel und Drehverschluss

glass with stainless steel cover
vidrio con tapa de acero inoxidable con rosca
en verre avec couvercle inox à visser

	cm	↑ cm
40310	10,5 x 6,5	16



Pfeffer- & Salz-Menage „CLASSIC“

salt- and pepper-menage
salero-pimentero
ménage sel et poivre



Glasbehälter mit Edelstahl-Deckel und Drehverschluss

glass with stainless steel cover
vidrio con tapa de acero inoxidable con rosca
en verre avec couvercle inox à visser

	Ø cm	↑ cm
40320	10,5	16



Menage „CLASSIC“

menage
menage
ménage



Glasbehälter mit Edelstahl-Deckel und tropffreiem Kunststoff-Ausgießer

with stainless steel cover and non-drip nozzle-spout
vidrio con tapa inox y sistema antigoteo
verre avec couvercle inox et verseur antigoutte

	cm	↑ cm	ltr.
40440	14,5 x 8,5	23	0,2
40450	17,5 x 10,5	23	

Ersatzglas mit Deckel / spare glass with cover / vidrio con tapa / verre + couvercle

	Ø cm	↑ cm	
40312	4	9	18 Löcher - Ø 1,35 mm
40311	4	9	6 Löcher - Ø 1,85 mm

Ersatzglas mit Deckel „Essig & Öl“ / spare glass with cover „vinegar & oil“ / cristal de recambio con tapa „vinegar & oil“ / verre huile ou vinaige avec couvercle inox et verseur antigoutte

	Ø cm	↑ cm	ltr.
40441	6	18,5	0,2

Ersatzglas mit Deckel „Zahnstocher“ / spare glass with cover „toothpick“ / porta-palillos vidrio con tapa / verre à cure-dents + couvercle

	Ø cm	↑ cm
40313	4	9



Senftöpfchen, 2er Set

mustard glass, 2 pcs. set
juego 2 piezas vasos mostaza
jeu de 2 verres à moutarde



inkl. Löffel und Edelstahl-Deckel

incl. spoons and covers
incluye cucharas y tapas
cuillères et couvercles inclus

	Ø cm	↑ cm	pcs.
40415	5	6	2

Tabletop



Menage „PRO“

menage
menage
ménage



matt poliert, Glasbehälter mit Edelstahl-Deckel und tropffreiem Kunststoff-Ausgießer
satin polished finish, glass with stainless steel cover and non-drip nozzle-spout
inox satinado, vidrio, sistema antigoteo
inox poli mat satiné et verre, insert plastique antigoutte

	cm	↑ cm
40476	12,0 x 8,0	19
40478	12,5 x 11,0	19
40480	13,0 x 11,0	19

Pfeffer- oder Salz-Glasstreuer / pepper- or salt-glass with cover / salero o pimentero de cristal con tapa
salière ou poivrière seule en verre avec couvercle inox

	Ø cm
40461	14

Essig- oder Öl-Glasbehälter / oil- or vinegar-glass with cover / aceiteira-vinagrera con tapa
bouteille huile ou vinaigre seule en verre et couv. inox

	Ø cm
40462	14



Menage „PRO“

menage
menage
ménage



matt poliert, Glasbehälter mit Edelstahl-Deckel und Drehverschluss
satin polished finish, glass with stainless steel cover
inox satinado, vidrio y tapas con rosca
inox poli mat satiné et verre, couvercle à visser

	cm	↑ cm
40470	8,5 x 5,7	11,5
40472	9,2 x 8,5	11,5
40474	10 x 10	11,5



Parmesan-Menage „CLASSIC“

cheese dish
quesera parmesano
service à parmesan



hochglanzpoliert, inkl. Löffel
mirror polished finish, with spoon
pulido efecto espejo, con bol cristal y cuchara
brillant, avec bol verre et cuillère

	Ø cm	↑ cm
40330	10,5	7

Ersatzbehälter / sparecontainer / bol de recambio / bol de rechange

	Ø cm	
40331	10,5	



Parmesan-Menage „PROFI“

cheese dish
quesera parmesano
service à parmesan



	Ø cm	↑ cm
40424	9	5,5

Ersatzbehälter / sparecontainer / bol de recambio / bol de rechange

	Ø cm	
40331	10,5	



Parmesan-Menage „PRO“

cheese dish
quesera parmesano
service à parmesan



matt poliert, inkl. Löffel
satin polished finish, with spoon
pulido mate satinado, con bol cristal y cuchara
mat satiné, avec bol verre et cuillère

	Ø cm	↑ cm
40482	10,5	13

Ersatzbehälter / sparecontainer / bol de recambio / bol de rechange

	Ø cm	
40331	10,5	



Parmesan-Menage „ECONOMIC“

cheese dish
quesera parmesano
service à parmesan



inkl. Kunststofflöffel
with spoon
con cuchara
avec cuillère

	Ø cm	↑ cm
40453	10,5	7

Ersatzbehälter / sparecontainer / bol de recambio / bol de rechange

	Ø cm	
40454	10,5	



40443
250 ml

40444
500 ml

Ständer

serving stand
soporte 2 botellas
support 2 bouteilles



matt poliert, passend für handelsübliche 500 ml Flaschen, Lieferung ohne Flaschen
satin polished finish, for standard bottles with 500 ml content, delivery without bottles
inox satinado, para botellas estándar de 500 ml, se entrega sin botellas
inox mat satiné, pour bouteilles standard de 500 ml, livré sans bouteilles

	cm	↑ cm
40443	13,0 x 7,0	30
40444	14,5 x 8,5	35



93308

93309

Spritzflasche inklusive Ausgießer

squeeze bottle with nozzle
botella exprimible con dosificador
flacon pulvérisateur avec bec verseur



ideal für Bitter-Liköre, Essig, Öl
perfect for bitter liqueur, vinegar, oil
perfecto para amargo licor, vinagre, aceite
pour amaro liqueur, vinaigre, huile

	cm	↑ cm	ltr.
93308	6 x 5	20	0,2

Ausgießer passend für Spritzflasche / nozzle suitable for squeeze bottle / dosificador apto para botella exprimible / bec verseur approprié pour flacon pulvérisateur

	Ø cm	↑ cm
93309	2,5	5,5



Gewürzständer

serving stand/rack
soporte salsas y condimentos
porte condiments et sauces



matt poliert, Lieferung ohne Deko
satin polished finish
acabado pulido efecto satinado
poli mat satiné

	Ø cm	↑ cm
40300	19	20



hot price

Menage

menage
menage
ménage



drehbares Gestell, Glasbehälter mit Edelstahl-Deckel und Drehverschluss
rotating frame, glass with stainless steel cover
soporte giratorio con piezas de vidrio y tapas inox
tournant, avec pièces en verre et couvercle inox

	Ø cm	↑ cm
40485	16	20



300 ml

Allzweckgießer

pourer
bote vertedor universal
pot verseur universel



für Honig, Kaffeesahne, etc., Schraubdeckel aus Edelstahl

for honey, cream, etc., cover stainless steel
para miel, crema, etc., tapa inoxidable
pour le miel, le lait, la crème, etc., couvercle inox

	Ø cm	↑ cm	ltr.
00765	8,5	13,5	0,3

Ersatzglasbehälter / spare glas-container / contenedor de repuesto / récipient verre de rechange

00768



300 ml

Zuckerdosierer

sugar dispenser
azucarero
sucrier



Schraubdeckel aus Edelstahl

cover stainless steel
tapa inoxidable
couvercle inox

	Ø cm	↑ cm	ltr.
00766	8,5	15	0,3

Ersatzglasbehälter / spare glas-container / contenedor de repuesto / récipient verre de rechange

00768



40490
150 ml

40494
250 ml

Zuckerdosierer

sugar dispenser
azucarero
sucrier



Schraubdeckel aus Edelstahl, mit Dosierrohr

cover stainless steel with dosing tube
tapa inoxidable y tubo dosificador
couvercle inox et tube doseur

	Ø cm	↑ cm	ltr.
40490	8,5	12	0,15
40494	8	15	0,25

Ersatzglasbehälter / spare glas-container / contenedor de repuesto / récipient verre de rechange

fits to

40498	40490
40499	40494



250 ml

Allzweckgießer

pourer
dosificador
doseur



Schraubdeckel aus Edelstahl und Kunststoff, mit Dosierklappe

cover stainless steel and plastic, with dosing flap
acero inoxidable y tapa plástico, con cierre dosificador
couvercle en inox et plastique, avec couvercle doseure

	Ø cm	↑ cm	ltr.
40488	8	12,5	0,25



250 ml

Zuckerdosierer

sugar dispenser
azucarero
sucrier



Schraubdeckel aus Edelstahl, mit Dosierrohr

cover stainless steel, with dosing tube
tapa inoxidable y tubo, con cierre dosificador
couvercle inox et tube doseur

	Ø cm	↑ cm	ltr.
40486	8	15	0,25



320 ml

Zuckerdosierer

sugar dispenser
azucarero
sucrier



Schraubdeckel aus Edelstahl, mit Dosier-Rohr

cover stainless steel, with dosing tube
tapa inoxidable y tubo dosificador
couvercle inoxydable et tube doseur

	Ø cm	↑ cm	ltr.
40506	7,5	17,0	0,32



320 ml

Zuckerdosierer

sugar dispenser
azucarero
sucrier



Schraubdeckel mit Klappe aus Edelstahl, mit Dosierklappe

cover stainless steel, with dosing flap
tapa acero inoxidable, con cierre dosificador
couvercle inox, avec couvercle doseure

	Ø cm	↑ cm	ltr.
40487	7,5	13,5	0,32



200 ml

Zuckerdosierer

sugar dispenser
azucarero
sucrier



mit Schraubverschluss, Dosier-Rohr Ø 15 mm
cover and dosingtube Ø 15 mm
con tapa y tubo dosificador Ø 15 mm
couvercle avec tube doseur Ø 15 mm

	Ø cm	↑ cm	ltr.
40508	6,5	14,5	0,20



10316
170 ml

10317
170 ml

Zuckerspender / Milchkännchen

sugar pourer / milk jug
dispensador de azúcar
sucrier doseur



matt poliert
satin polished finish
pulido efecto satinado
intérieur et extérieur poli mat

	Ø cm	↑ cm	ltr.
10316	5	15	0,17
10317	5	11,5	0,17



Zuckerkuigel

sugar pot
azucarero
sucrier



hochglanzpoliert, mit Rolldecke
mirror polished finish, rolltop cover
pulido acabado brillante, tapa abatible
brillant, couvercle abattant

	Ø cm	↑ cm
00033	13,5	15



Milch- / Zucker-Set

sugar-creamer-set
set para azúcar y leche
plateau avec sucrier et crémier



hochglanzpoliert, Sahnegießer, Zuckerdose, inkl. Löffel
mirror polished finish, milk jug, sugar bowl, incl. spoon
pulido brillante, con jarrita de leche, azucarero y cuchara
brillant, avec crémier, sucrier et cuillère

	cm	↑ cm
00635	15 x 11	6,5



Butterservierer

butter dish
mantequillera
beurrier

hochglanzpoliert
mirror polished finish
acabado brillante
poli brillant



	Ø cm	↑ cm
15921	9	7



Butterservierer

butter dish
mantequillera
beurrier



	Ø cm	↑ cm
15925	9	9



Butterservierer

butter dish
mantequillera
beurrier



	cm	↑ cm
15926	9 x 9	9



Butterdose

butter dish
mantequillera
beurrier



	cm	↑ cm
00062	18,5 x 12,5	5



Schale „ENAMELWARE“

bowl
cuenco
bol



	cm	↑ cm
40667	16 x 12	3,5
40668	18 x 13,5	4,0



Kühlschrank-Butterdose

refrigerator butter dish
mantequillera para nevera
boîte à beurre pour le frigo



	cm	↑ cm
00063	16 x 9,5	5,5

VINTAGE

NEW



Holzbox „VINTAGE“

woodbox
caja madera
base bois



Schubladenoptik, mit Knopf

drawer look, with knob
look cajón, con pomo
look tiroir, avec bouton

	cm	↑ cm	
11631	18,5 x 18,5	11	Innenmaß: 17 x 17 cm, mit Beschriftungsfach
11630	11,5 x 7,5	5	Innenmaß: 10 x 6 cm



Holzbox „VINTAGE“

woodbox
caja madera
base bois



Schubladenoptik, mit Knopf

drawer look, with knob
look cajón, con pomo
look tiroir, avec bouton

	cm	↑ cm	
11633	18,5 x 18,5	11	Innenmaß: 17 x 17 cm, mit Beschriftungsfach
11632	11,5 x 7,5	5	Innenmaß: 10 x 6 cm

Tabletop



Table Caddy „VINTAGE“

table caddy
caddy de mesa
caddy de table



herausnehmbare Aufteilung, 4-Fächer (7 x 7 cm)
separation removable, 4 compartments (7 x 7 cm)
separadores amovibles, 4 compartimentos (7 x 7 cm)
séparateurs amovibles, 4 compartiments (7 x 7 cm)

	cm	↑ cm	Farbe / Colour
11635	17 x 17	10	
11636	17 x 17	10	
11637	17 x 17	10	



Table Caddy „VINTAGE“

table caddy
caddy de mesa
caddy de table



herausnehmbare Aufteilung, 6 Fächer (7,5 x 7,5 cm)
separation removable, 6 compartments (7,5 x 7,5 cm)
separadores amovibles, 6 compartimentos (7,5 x 7,5 cm)
séparateurs amovibles, 6 compartiments (7,5 x 7,5 cm)

	cm	↑ cm	Farbe / Colour
11638	27 x 17	10	
11639	27 x 17	10	
11640	27 x 17	10	

NEW



11600



11601



11602

Table Caddy „VINTAGE“

table caddy
caddy de mesa
caddy de table



herausnehmbare Aufteilung, 4-Fächer (7 x 7 cm)
separation removable, 4 compartments (7 x 7 cm)
separadores amovibles, 4 compartimentos (7 x 7 cm)
séparateurs amovibles, 4 compartiments (7 x 7 cm)

	cm	↑ cm	Farbe / Colour
11600	17 x 17	16	
11601	17 x 17	16	
11602	17 x 17	16	

NEW



11603



11604



11605

Table Caddy „VINTAGE“

table caddy
caddy de mesa
caddy de table



herausnehmbare Aufteilung, 6 Fächer (7,5 x 7,5 cm)
separation removable, 6 compartments (7,5 x 7,5 cm)
separadores amovibles, 6 compartimentos (7,5 x 7,5 cm)
séparateurs amovibles, 6 compartiments (7,5 x 7,5 cm)

	cm	↑ cm	Farbe / Colour
11603	27 x 17	16	
11604	27 x 17	16	
11605	27 x 17	16	

WOODY

NEW



11650



11651



stapelbar / stackable
apilables / empilable



Die einfach geometrische Formensprache der Holzboxen „WOODY“ macht diesen puristischen Artikel zum Hingucker. Durch die Echtholzstruktur der Akazie ist jede Box ein Unikat. Die Innenmaße der asymmetrischen Aufteilung nimmt viele APS-Artikel perfekt auf. Die Kanten verhindern ein Verrutschen beim Stapeln der Holzboxen „WOODY“.

The simple geometric form of the wooden boxes „WOODY“ makes this puristic article a real eye-catcher. Thanks to the real wood structure of the acacia, each box is unique. The internal dimensions of the asymmetrical division are perfect for many APS articles. The edges prevent slipping when stacking the wooden boxes „WOODY“.

La forma geométrica simple de las cajas de madera „WOODY“ hace que este artículo purista llame la atención. Gracias a la estructura de madera real de la acacia, cada caja es única. La medida del interior de la división asimétrica es perfecta para muchos artículos de APS. Los bordes doblados evitan que se resbalen al apilar las cajas de madera „WOODY“.

La forme géométrique simple des boîtes en bois „WOODY“ rend cet article puriste dans un véritable point de mire. Grâce à la structure en bois réelle de l'Acacia, chaque boîte est unique. Les dimensions intérieures de la division asymétrique sont parfaites pour de nombreux articles APS. Les bords pliés empêchent de glisser en empilant les boîtes en bois „WOODY“.



11650

11651

Holzbox „WOODY“

woodbox
caja madera
base bois

Akazienholz
acacia wood
madera de acacia



	cm	↑ cm	
11650	15,0 x 15,0	5,5	Innenmaß: 13 x 13 cm
11651	22,5 x 15,0	5,5	Innenmaß: 13,5 x 13 / 6,5 x 13 cm

NEW



Table Caddy „VINTAGE“

table caddy
caddy de mesa
caddy de table

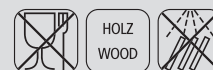

aus Pinienholz, 2-Fächer (13,5 x 6 cm)
pinewood, 2 compartments (13,5 x 6 cm)
de madera de pino, 2 compartimentos (13,5 x 6 cm)
en bois de pin, 2 compartiments (13,5 x 6 cm)

	cm	↑ cm	
40404	15,5 x 15,5	15	Innenmaß: 13,5 x 6 cm



Table Caddy

table caddy
caddy de mesa
caddy de table

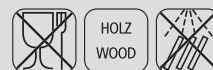

Akazienholz
acacia wood
madera de acacia
bois d'acacia

	cm	↑ cm	
11625	23 x 10	10	Innenmaß: 22,5 x 6 cm



Table Caddy

table caddy
caddy de mesa
caddy de table



Akazienholz, 2-Fächer
acacia wood, 2 compartements
madera de acacia, 2 compartimentos
bois d'acacia, 2 compartiments

	cm	↑ cm	
40405	25 x 15	18	Innenmaß: 21,5 x 8 cm



Kerzenleuchter
candle holder
candelabro
chandelier



hochwertige Gastro Ausführung, möbelschonende Unterseite
heavy quality, with non-scratching undersurface
alta calidad, con base antirralladuras
haute qualité, avec base revêtue antirayures

	cm	↑ cm	
04001	27,5 x 27,5	25	5-flammig / 5-lids / 5 ramas / 5 branches
04002	27,5 x 11	25	3-flammig / 3-lids / 3 ramas / 3 branches
	Ø cm	↑ cm	
04003	11	22	1-flammig / 1 lid / 1 rama / 1 branche
04004	11	10	1-flammig / 1 lid / 1 rama / 1 branche



Kerzenleuchter „XXL“
candle holder
candelabro
chandelier



5-flammig, Zinkdruckguss, vernickelt, schwere Ausführung, einfache Montage
5 branches, zinc alloy nickel-plated, heavy model, easy to assemble
5 ramas, fundición de aleación de zinc niquelada, alta calidad y fácil montaje
5 branches, fonte d'alliage de zinc nickelée, haute qualité, facile à monter

	cm	↑ cm	
04000	46 x 46	56	5-flammig / 5-lids / 5 ramas / 5 branches
04012	46 x 46	78	5-flammig / 5-lids / 5 ramas / 5 branches
04013	46 x 46	98	5-flammig / 5-lids / 5 ramas / 5 branches



Kerzenleuchter „XL“

candle holder
candelabro
grand chandelier



extra hoch und schwer, möbelschonende Unterseite
extra high and heavy, with non-scratching undersurface
pesado y de alta calidad, con base antirralladuras
lourd et de haute qualité, avec base revêtue antirayures

	cm	↑ cm	
04005	35 x 13	39	3-flammig / 3-lids / 3 ramas / 3 branches



Kerzenleuchter „XL“

candle holder
candelabro
grand chandelier



extra hoch und schwer, möbelschonende Unterseite
extra high and heavy, with non-scratching undersurface
pesado y de alta calidad, con base antirralladuras
lourd et de haute qualité, avec base revêtue antirayures

	cm	↑ cm	
04006	35 x 35	39	5-flammig / 5-lids / 5 ramas / 5 branches



Kerzenleuchter „CLASSIC“, 2er Set

candle holder, 2 pcs. set
candelabros, set de 2 piezas
set de 2 chandeliers



möbelschonende Unterseite
with non-scratching undersurface
con base antirralladuras
avec base revêtue antirayures

	Ø cm	↑ cm	pcs.
04035	10	20,5	2

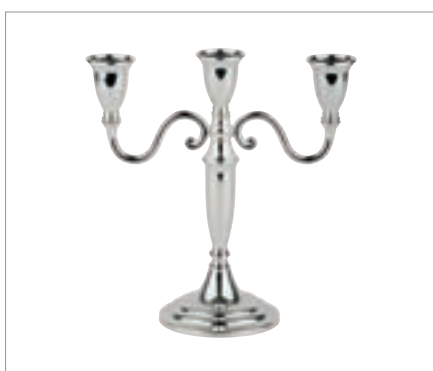

Kerzenleuchter „CLASSIC“

candle holder
candelabro
chandelier



möbelschonende Unterseite
with non-scratching undersurface
con base antirralladuras
avec base revêtue antirayures

	cm	↑ cm	
04036	22 x 10	22,5	3-flammig / 3-lids / 3 ramas / 3 branches



Kerzenleuchter „CLASSIC“

candle holder
candelabros
chandelier



möbelschonende Unterseite
with non-scratching undersurface
con base antirralladuras
avec base revêtue antirayures

	cm	↑ cm	
04037	22 x 22	24	5-flammig / 5-lids / 5 ramas / 5 branches



Kerzenleuchter, 2er Set
candle holder, 2 pcs. set
candelabros, set de 2 piezas
set de 2 chandeliers



möbelschonende Unterseite
with non-scratching undersurface
con base antirralladuras
avec base revêtue antirayures

	Ø cm	↑ cm	pcs.
04008	6	7	2



Kerzenleuchter
candle holder
candelabro
chandelier



extra schwerer Fuß, Kupfer-look, möbelschonende Unterseite
heavy foot, copper look, with table gentler bottom, with non-scratching undersurface
pie pesado, cobre en color, con mesa de fondo suave, con base antirralladuras
pied lourd, couleur cuivre, avec table de fond doux, avec base revêtue antirayures

	Ø cm	↑ cm	Farbe / Colour
04024	10	11	
04025	10	16	
04026	10	22	



Kerzenleuchter
candle holder
candelabro
chandelier



extra schwerer Fuß, verchromt, möbelschonende Unterseite
heavy foot, chrome plated, with non-scratching undersurface
pie pesado, asa cromado, con base antirralladuras
pied lourd, chromé, avec base revêtue antirayures

	Ø cm	↑ cm	Farbe / Colour
04020	10	11	
04021	10	16	
04022	10	22	



Windlicht / Tischleuchte
wind light
porta velas
porte-bougie de table, anti-vent



möbelschonende Unterseite
with non-scratching undersurface
con base antirralladuras
avec base revêtue antirayures

	Ø cm	↑ cm
03013	11	22

Ersatzglas / spare glass / vidrio de recambio solo / verre de rechange transparent, seul

03015



Windlicht „BALL“

wind light
porta vela
lampe à bougie



poliert, Glas satiniert, schwere standsichere Ausführung, möbelschonende Unterseite
mirror polished finish, heavy quality, with non-scratching undersurface
acabado efecto espejo, alta calidad, base pesada, con base antirralladuras
poli brillant, belle qualité, pied pesant, avec base revêtue antirayures

	Ø cm	↑ cm
03033	12	11,5



Windlichter, 2er Set

wind lights, 2 pcs. set
set de 2 piezas porta velas
set de 2 porte-bougies anti-vent



hochglanzpoliert, Gläser klar, möbelschonende Unterseite
mirror polished finish, glasses clear, with non-scratching undersurface
acabado pulido brillante, vidrio transparente, con base antirralladuras
brillant, verre transparent, avec base revêtue antirayures

	Ø cm	↑ cm	pcs.
03026	5	8	2

Ersatzglas / spare glass / vidrio de recambio solo / verre de rechange transparent, seul

03027



Windlichter, 2er Set

wind lights, 2 pcs. set
set de 2 portavelas antiviento
set de 2 porte-bougies anti-vent



matt poliert, Gläser satiniert, möbelschonende Unterseite
satin polished finish, glasses satin, with non-scratching undersurface
acabado pulido mate satinado, cristales satinados, con base antirralladuras
inox mat satiné et verre mat, avec base revêtue antirayures

	Ø cm	↑ cm	pcs.
03016	7,5	12,5	2

Ersatzglas / spare glass / cristal de recambio / verre de rechange

03028



Windlichter, 2er Set

wind lights, 2 pcs. set
set de 2 portavelas antiviento
set de 2 porte-bougies anti-vent



matt poliert, Gläser satiniert, möbelschonende Unterseite
satin polished finish, glasses satin, with non-scratching undersurface
pulido acabado efecto satinado, cristales satinados, con base antirralladuras
inox mat satiné et verre mat, avec base revêtue antirayures

	Ø cm	↑ cm	pcs.
03020	5	15	2

Ersatzglas / spare glass / cristal de recambio / verre de rechange

03025



Windlichter „ELEMENT“, 2er Set

wind lights, 2 pcs. set
set de 2 portavelas antiviento
set de 2 porte-bougies anti-vent



Beton, Gläser klar, mit möbelschonender Unterseite
concrete, glasses clear
hormigón, vidrio transparente
bèton, verre transparente

	Ø cm	↑ cm	pcs.
03038	6	8	2

Ersatzglas / spare glass / vidrio de recambio solo / verre de rechange transparent, seul

	Ø cm	↑ cm
03098	6	5



Windlicht „ELEMENT“

wind light
porta vela
porte-bougie



Beton, Glas klar, mit möbelschonender Unterseite
concrete, glass clear
hormigón, vidrio transparente
bèton, verre transparente

	Ø cm	↑ cm
03039	7,5	13

Ersatzglas / spare glass / vidrio de recambio solo / verre de rechange transparent, seul

	Ø cm	↑ cm
03099	7,5	9



Vase
flower vase
florero
vase soliflor



hochglanzpoliert, schwerer Fuß, möbelschonende Unterseite
mirror polished finish, heavy quality
pulido brillante, alta calidad
brillant, bonne qualité

	Ø cm	↑ cm	kg
04018	6	19	0,23



Vase
flower vase
florero
vase soliflor



Edelstahl-Look, Zinkdruckguss, vernickelt, lackiert, anlaufgeschützt, schwere Ausführung
stainless steel look, heavy zink alloy, nickel plated, laquered
aspecto acero, acabado satinado, alta calidad
aspect inox, fini mat satiné, bonne qualité

	Ø cm	↑ cm	kg
04017	6,5	18	0,36



Vase
flower vase
florero
vase soliflor



Edelstahl-Look, Zinkdruckguss, vernickelt, lackiert, anlaufgeschützt, schwere Ausführung
stainless steel look, heavy zink alloy, nickel plated, laquered
aspecto acero, acabado satinado, alta calidad
aspect inox, fini mat satiné, bonne qualité

	Ø cm	↑ cm	kg
04015	4	16,5	0,17
04016	4,5	20	0,20

Tischsets



Auch ohne die klassisch weiße Tischdecke setzen Sie mit den vielfältigen Tischsets schöne Akzente auf Ihrem gedeckten Tisch. Die umgelegten und angenähten Kanten machen diese Tischsets besonders robust. Geliefert in einer 6er Einheit.

Even without the classic white tablecloth you can set beautiful accents on your table with the various table sets. The folded and sewn edges make these table sets particularly robust. Delivered in a packing unit of 6 pieces.

Incluso sin el mantel blanco clásico puede poner un acento a su mesa con los múltiples mantelitos de mesa. Los bordes doblados y cosidos des los mantelitos los hacen especialmente resistentes. Se entregan en una unidad de embalaje de 6 piezas.

Même sans la nappe blanche classique vous donnez un bel accent à votre table en utilisant de multiples sets de table. Les bords repliés et cousus rendent ces sets de table en particulièrement robustes. Livré dans un emballage de 6 pièces.



Warenträger - Tischsets

display for table sets
expositor para mantelinas de mesa
présentoir pour sets de table

**12 Einschubfächer, komplett auf Rollen, 2 Feststellrollen,
Lieferung demontiert**

12 shelves, on rolls, 2 rolls to fix, delivery unassembled

12 niveles, 4 ruedas, desmontado (montaje fácil)

12 niveaux, 4 roues, livré démonté

	cm	↑ cm
00401	39,5 x 45	165



60525 - white

Tischset Schmalband
 placemat smallband
 mantelín cinta estrecha
 set de table tressage étroit



	cm		VE / unit
60525	45 x 33	weiß / white	6
60526	45 x 33	gold / gold	6
60527	45 x 33	silber / silver	6
60528	45 x 33	grün / green	6

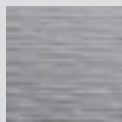

60525 - white

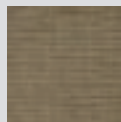

60526 - gold

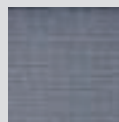

60527 - silver

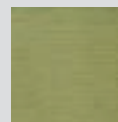

60528 - green

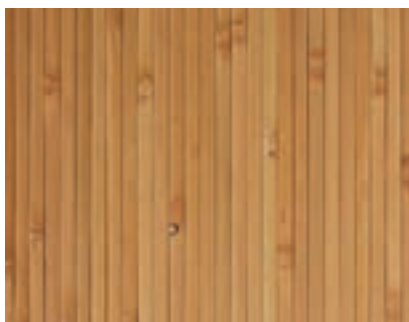

60538 - nature

Tischset „BAMBUS“
 placemat
 mantelín
 set de table

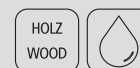

Original Natur-Bambus, handgemacht
 original nature bamboo, hand made
 bambú natural, hecho a mano
 bambou naturel, fabriqué à main

	cm		VE / unit
60538	45 x 33	natur / nature	6
60539	45 x 33	grün / green	6

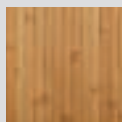

60538 - nature

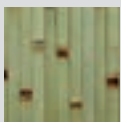

60539 - green

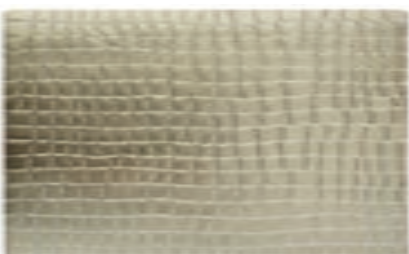

60535 - gold

Tischset „CROCO“
 placemat
 mantelín
 set de table



rutschhemmende Unterseite
 slip resistant underside
 antideslizante por debajo
 dessous antiglisse

	cm		VE / unit
60535	45 x 30	gold / gold	6
60536	45 x 30	kupfer / copper	6
60537	45 x 30	braun / brown	6

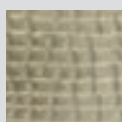

60535 - gold

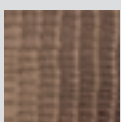

60536 - copper

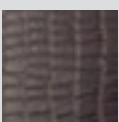

60537 - brown

60536 - copper



Tischset Breitband
 placemat wide band
 mantelín de mesa
 set de table



	cm		VE / unit
60008	45 x 33	schwarz / black	6
60000	45 x 33	sahara / sahara	6
60007	45 x 33	blau / blue	6
60010	45 x 33	anthrazit / anthracite	6
60030	45 x 33	plum / violette	6
60031	45 x 33	lime / lime	6
60032	45 x 33	grasgrün / grass green	6

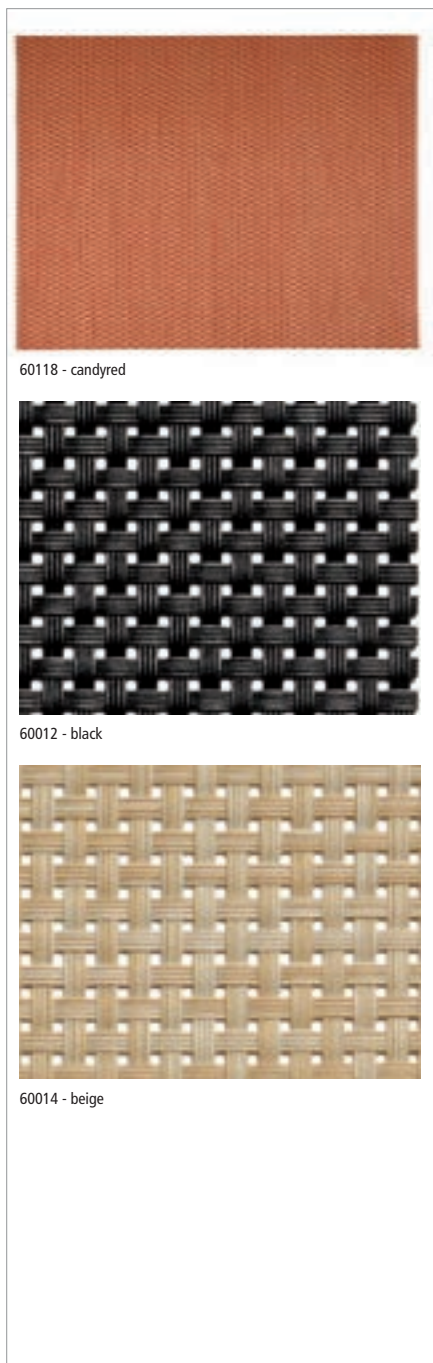
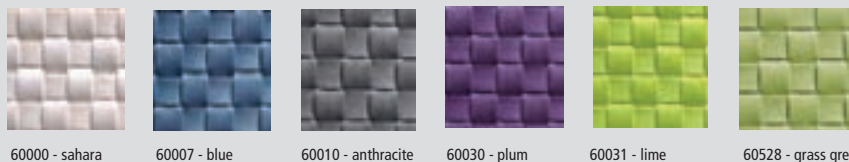

Tischset Schmalband
 placemat smallband
 mantelín cinta estrecha
 set de table tressage étroit



	cm		VE / unit
60018	45 x 33	candyrot / candyred	6
60012	45 x 33	schwarz / black	6
60014	45 x 33	beige / beige	6
60015	45 x 33	silbergrau / silvergrey	6
60016	45 x 33	grün / green	6
60017	45 x 33	lila / purple	6
60019	45 x 33	beige braun / beige brown	6
60522	45 x 33	orange / orange	6
60520	45 x 33	schwarz weiß / black white	6
60521	45 x 33	apfelgrün / apple green	6
60523	45 x 33	violett / purple	6
60524	45 x 33	platin / platinum	6
60002	45 x 33	hellblau / light blue	6
60009	45 x 33	rot / red	6
60011	45 x 33	orange / orange	6

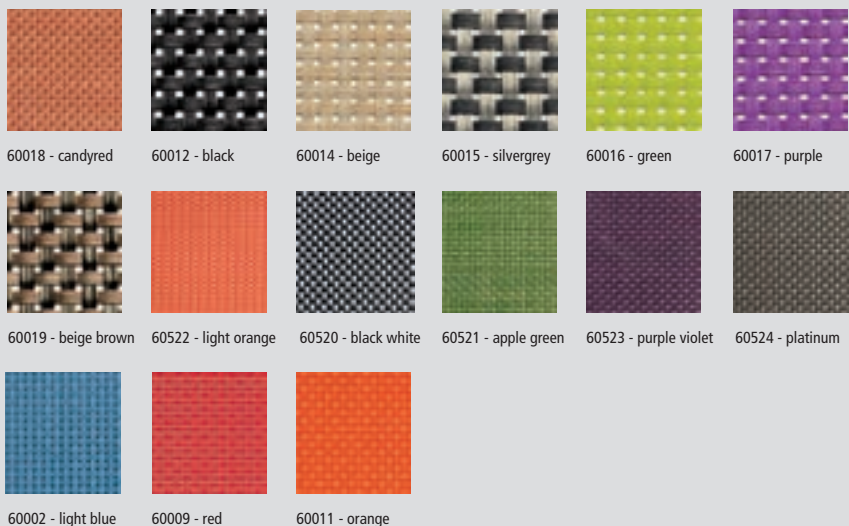



Tischset Schmalband
 placemat smallband
 matelin cinta estrecha
 set de table tressage étroit



	cm		VE / unit
60041	45 x 33	hellblau, weiß / light blue, white	6
60043	45 x 33	hellbraun, braun, beige / light brown, brown, beige	6

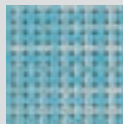

60041 - light blue, white

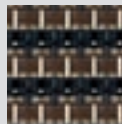

60043 - light brown, brown, beige



Tischset Feinband
 placemat fine band
 mantelin
 set de table



	cm		VE / unit
60042 ^{NEW}	45 x 33	türkis, grün, weiß / turquoise, green, white	6
60509	45 x 33	Mosaik schwarz, grau / black, grey	6
60512	45 x 33	schwarz, grau / black, grey	6
60542	45 x 33	rot / red	6



60042 - turquoise, green, white

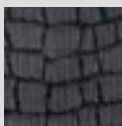

60509 - black, grey

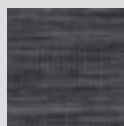

60512 - black, grey

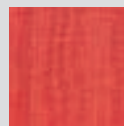

60542 - red

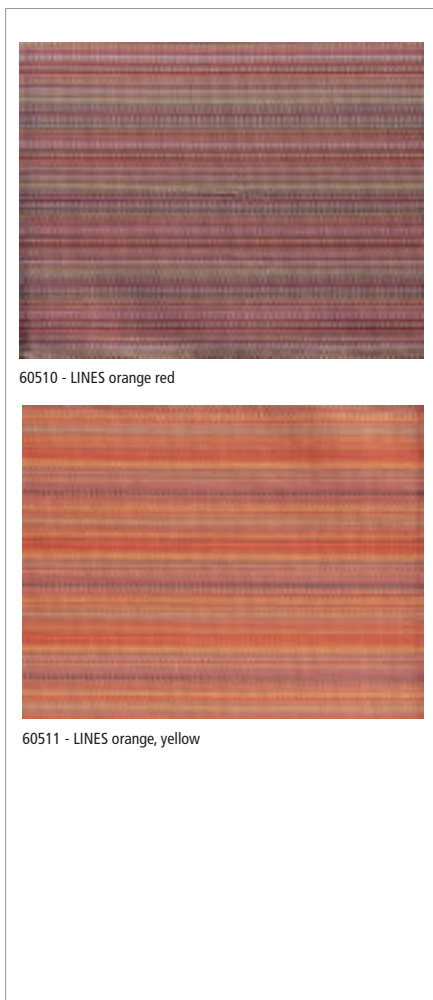

Tischset Feinband
 placemat fine band
 mantelin cinta fina
 set de tables



	cm		VE / unit
60510	45 x 33	LINES orange, rot / LINES orange red	6
60511	45 x 33	LINES orange, gelb / LINES orange yellow	6
60531	45 x 33	LINES schwarz / LINES black	6
60532	45 x 33	LINES pastell / LINES pastell	6
60533	45 x 33	LINES bordeaux / LINES bordeaux	6
60534	45 x 33	LINES rot / LINES red	6
60530	45 x 33	STRIPES grau / STRIPES grey	6
60540	45 x 33	FRAMES grau / FRAMES grey	12
60541	45 x 33	FRAMES schwarz / FRAMES black	12

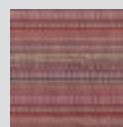

60510 - LINES orange red

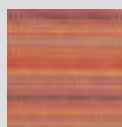

60041 - LINES orange, yellow

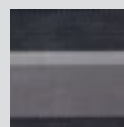

60531 - LINES black

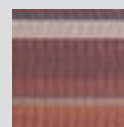

60532 - LINES pastell

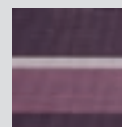

60533 - LINES bordeaux

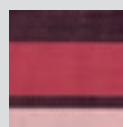

60534 - LINES red

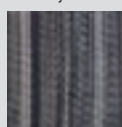

60530 - LINES grey

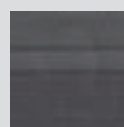

60540 - FRAMES grey

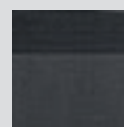

60540 - FRAMES black



Tischset Feinband „GLÄSER“
 placemat fine band
 mantelín cinta fina
 sets de table, tressage fin

PVC KUNSTSTOFF

	cm		VE / unit
60514	45 x 33	lemon-grün / lemon green	6

60514 - lemon green



Tischset Feinband
 placemat fine band
 mantelínes
 sets de tables

PVC KUNSTSTOFF

	cm		VE / unit
60033	45 x 33	silber / silver	6
60034	45 x 33	braun / brown	6
60035	45 x 33	rot / red	6
60036	45 x 33	lila / purple	6
60037	45 x 33	gold / gold	6
60038	45 x 33	beige braun / beige brown	6
60039	45 x 33	rot braun / red brown	6
60040	45 x 33	blau / blue	6

60033 - silver

60034 - brown

60035 - red

60036 - purple

60037 - gold

60038 - beige brown

60039 - red brown

60040 - blue



Tischset Feinband „TAO“
 placemat fine band
 mantelín cinta fina
 set de table, tressage fin

PVC KUNSTSTOFF

	cm		VE / unit
60502	45 x 33	grau, beige / grey, beige	6
60503	45 x 33	beige / beige	6
60505	45 x 33	braun / brown	6

60502 - grey, beige

60503 - beige

60505 - brown



Schmalband Tischläufer

table runner fine fabric
camino de mesa
chemin de table



pflegeleichtes Kunststoffgeflecht
easy to clean
fácil de limpiar
nettoyage aisé

	cm	
60022	45 x 150	schwarz / black
60024	45 x 150	beige, braun / beige, brown
60020	45 x 150	beige / beige
60021	45 x 150	candyrot / candyred
60023	45 x 150	silbergrau / silver grey



Servietten- und Bestecktaschen, 6er Set

cutlery bag, 6 pcs.
bolsa cubiertos, 6 pz.
pochette couverts, 6 pc.



	cm		VE / unit
60551	24 x 9	silbergrau / silvergrey	6
60550	24 x 9	beige / beige	6
60552	24 x 9	beige braun / beige brown	6
60553	24 x 9	apfelgrün / apple green	6
60554	24 x 9	platin / platinum	6



60550 - beige

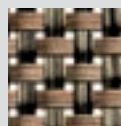

60552 - beige/braun

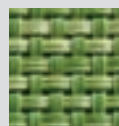

60553 - apfelgrün

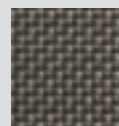

60554 - platin





Körbe

baskets
cestas
corbeilles

SUPERSTRONG



GN 1/1 Korb „SUPERSTRONG“

GN 1/1 basket
GN 1/1 cesta
GN 1/1 corbeille



	cm	↑ cm	GN	Farbe / Colour
50640	53,0 x 32,5	6,5	1/1	
50641	53,0 x 32,5	10,0	1/1	
50642	53,0 x 32,5	15,0	1/1	
50643	53,0 x 32,5	6,5	1/1	
50644	53,0 x 32,5	10,0	1/1	
50645	53,0 x 32,5	15,0	1/1	

GN Kuppelhaube / GN cover / GN cúpula / GN cloche bombée

	cm	↑ cm	GN
11027	54 x 33	20	1/1

GN Abdeckhaube / GN cover / GN cubierta / GN cloche

	cm	↑ cm	GN
11042	53,0 x 32,5	9,5	1/1

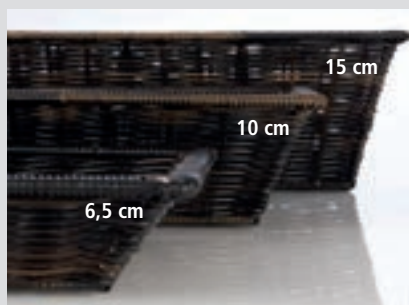

PROFI LINE

**Korb, rund „PROFI LINE“**

basket, round
cesta redonda
corbeille ronde



	Ø cm	↑ cm
50210	37	9
50215	42	12

**Korb, rund „PROFI LINE“**

basket, round
cesta redonda
corbeille ronde



	Ø cm	↑ cm
50205	31 / 37	12 / 6

**Korbschütte, rund „PROFI LINE“**

basket, round
cesta redonda
corbeille ronde



	Ø cm	↑ cm
50100	36,5	12,0
50105	42,0	18,5
50110	46,0	18,5

**Systemkorb, gestäbt „PROFI LINE“**

basket
cesta
corbeille



	cm	↑ cm
50300	30 x 40	27 / 16
50305	45 x 40	27 / 16
50310	60 x 40	27 / 16

**Systemkorb „PROFI LINE“**

basket
cesta
corbeille



	cm	↑ cm
50400	40 x 50	25 / 14

**Trenner „PROFI LINE“**

divider
divisor
paroi de séparation



	↑ cm	→ cm
50315	26 / 15	38

Körbe



Brötchenschütte „PROFI LINE“

roll / bun basket
cesta para bollos
corbeille à petits pains



	cm	↑ cm
50510	60 x 40	60



Stangenbrotkorb „PROFI LINE“

baguette basket
cesta de baguette
corbeille à baguettes



	Ø cm	↑ cm	Farbe / Colour
50500	28 / 30	38	
50501	28 / 30	38	



Korb Bäcker-Maß „PROFI LINE“

basket baker size
cesta tamaño panaderia
corbeille à pâtisserie dimensions „boul-pâte“



	cm	↑ cm
50900	40 x 20	5
50905	40 x 30	5
50910	60 x 20	5
50915	60 x 40	5



Auslage Tablett flach, Bäcker-Maß „PROFI LINE“

display tray flat, baker size
bandeja de presentación, tamaño panaderia
plateau de présentation, dimensions „boul-pâte“



	cm	↑ cm
40296	40 x 30	1
40297	60 x 40	1

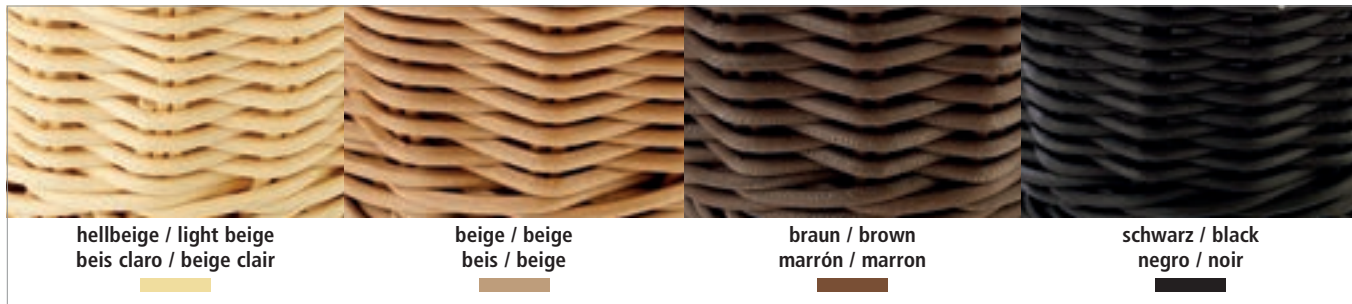

hellbeige / light beige
beis claro / beige clair

beige / beige
beis / beige

braun / brown
marrón / marron

schwarz / black
negro / noir



GN 1/1 Korb „PROFI LINE“

GN 1/1 basket
GN 1/1 cesta
GN 1/1 corbeille



	cm	↑ cm	Farbe / Colour
50720	53 x 32,5	10	
50721	53 x 32,5	10	
50723	53 x 32,5	10	
50722	53 x 32,5	10	



Korb, rechteckig „PROFI LINE“

basket, rectangular
cesta rectangular
corbeille rectangulaire



	cm	↑ cm	Farbe / Colour
50710	40 x 30	10	
50711	40 x 30	10	
50713	40 x 30	10	
50712	40 x 30	10	



Korb, rechteckig „PROFI LINE“

basket, rectangular
cesta rectangular
corbeille rectangulaire



	cm	↑ cm	Farbe / Colour
50700	26,5 x 19,0	7	
50701	26,5 x 19,0	7	
50703	26,5 x 19,0	7	
50702	26,5 x 19,0	7	

	cm	↑ cm	Farbe / Colour
50705	31,0 x 21,0	9	
50706	31,0 x 21,0	9	
50708	31,0 x 21,0	9	
50707	31,0 x 21,0	9	

Körbe



Baguette Korb, oval „PROFI LINE“

baguette basket, oval
cesta de baguette, oval
corbeille à baguettes, ovale



	cm	↑ cm	Farbe / Colour
50805	28 x 16	8	
50806	28 x 16	8	
50808	28 x 16	8	
50807	28 x 16	8	

	cm	↑ cm	Farbe / Colour
50820	40 x 16	8	
50821	40 x 16	8	
50823	40 x 16	8	
50822	40 x 16	8	



Korb, oval „PROFI LINE“

basket, oval
cesta oval
corbeille ovale



	cm	↑ cm	Farbe / Colour
50800	25 x 19	6,5	
50801	25 x 19	6,5	
50803	25 x 19	6,5	
50802	25 x 19	6,5	

	cm	↑ cm	Farbe / Colour
50815	32 x 23	7,0	
50816	32 x 23	7,0	
50818	32 x 23	7,0	
50817	32 x 23	7,0	



Korb, rund „PROFI LINE“

basket, round
cesta redonda
corbeille ronde



	Ø cm	↑ cm	Farbe / Colour
50600	16	8	
50601	16	8	
50603	16	8	
50602	16	8	

	Ø cm	↑ cm	Farbe / Colour
50605	20	8	
50606	20	8	
50608	20	8	
50607	20	8	

	Ø cm	↑ cm	Farbe / Colour
50610	29	7	
50611	29	7	
50613	29	7	
50612	29	7	



50624

Korb, oval „PROFI LINE“

basket, oval
cesta, oval
corbeille, ovale



	cm	↑ cm	Farbe / Colour
50624	19 x 12	6	
50625	19 x 12	6	
50626	19 x 12	6	
50627	19 x 12	6	



Korb, rechteckig „PROFI LINE“

basket, rectangular
cesta rectangular
corbeille rectangulaire



	cm	↑ cm	Farbe / Colour
50632	17 x 11	9	
50633	17 x 11	9	
50635	17 x 11	9	
50634	17 x 11	9	

	cm	↑ cm	Farbe / Colour
50628	19 x 13	6	
50629	19 x 13	6	
50630	19 x 13	6	
50631	19 x 13	6	



50620

50621

50622

50623

Korb, rund „PROFI LINE“

basket, round
cesta, redonda
corbeille, ronde



	Ø cm	↑ cm	Farbe / Colour
50620	13	10	
50621	13	10	
50622	13	10	
50623	13	10	

GN LINE

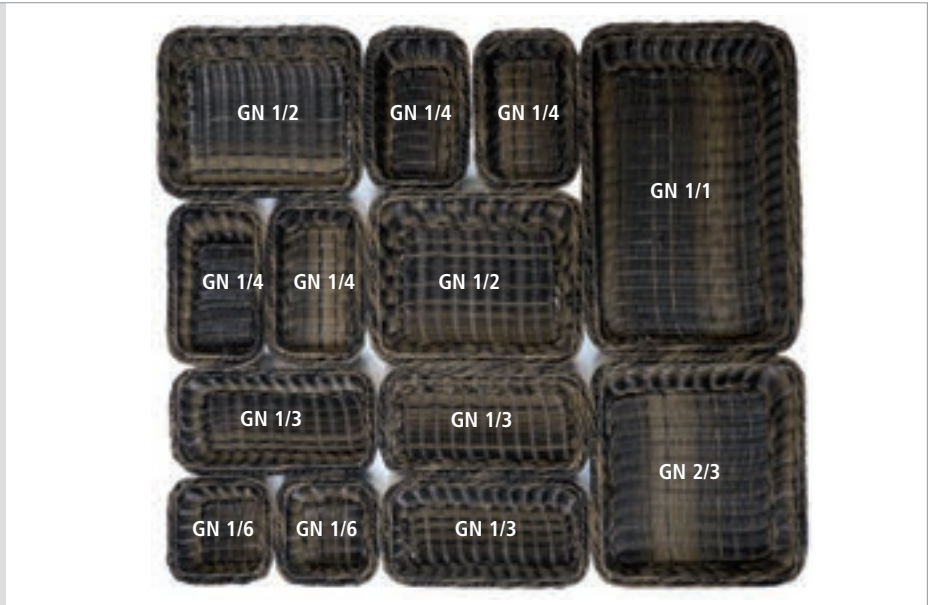
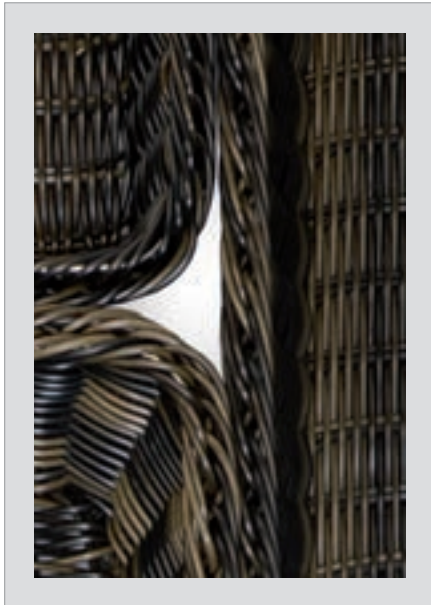

2 Höhen - 6,5 und 10 cm
2 heights - 6,5 and 10 cm

40293
GN 1/1 - 10 cm

40292
GN 1/2 - 10 cm

40225
GN 1/4 - 6,5 cm

Korb „GN LINE“
 GN basket
 GN cesta
 GN corbeille

stabile Ausführung mit Edelstahldraht im Rand zur Stabilisierung
 very solid with stainless steel wire frame to stabilize the basket
 muy resistente con refuerzo de alambre inox
 très résistante avec son fil de renfort inox

	cm	↑ cm	GN	Farbe / Colour
40291	53,0 x 32,5	6,5	1/1	
40290	32,5 x 26,5	6,5	1/2	
40223	32,5 x 17,5	6,5	1/3	
40225	26,5 x 16,2	6,5	1/4	
40227	17,6 x 16,2	6,5	1/6	
40229	32,5 x 35,4	6,5	2/3	

	cm	↑ cm	GN	Farbe / Colour
40293	53,0 x 32,5	10,0	1/1	
40292	32,5 x 26,5	10,0	1/2	
40243	32,5 x 17,5	10,0	1/3	
40245	26,5 x 16,2	10,0	1/4	
40247	17,6 x 16,2	10,0	1/6	
40249	32,5 x 35,4	10,0	2/3	

GN 1/1

GN 1/1 Besteckbehälter
 GN 1/1 dispenser GN
 GN 1/1 dispensador de cubiertos
 GN 1/1 bac à couverts

in Handarbeit geflochten, 4 Mulden, Kunststoff-Geflecht, Drahtgestell, braun-schwarz wickerwork, 4 compartments, with reinforced chromed wire structure, brown-black cesta trensada a mano, 4 compartimentos, de plástico, con bastidor cromado reforzado, marrón oscuro corbeille tressée à main, 4 compartiments, en plastique, cadre acier chromé renforcé, couleur marron foncé

	cm	↑ cm	GN	Farbe / Colour
11966	53 x 32,5	9	1/1	

GN LINE

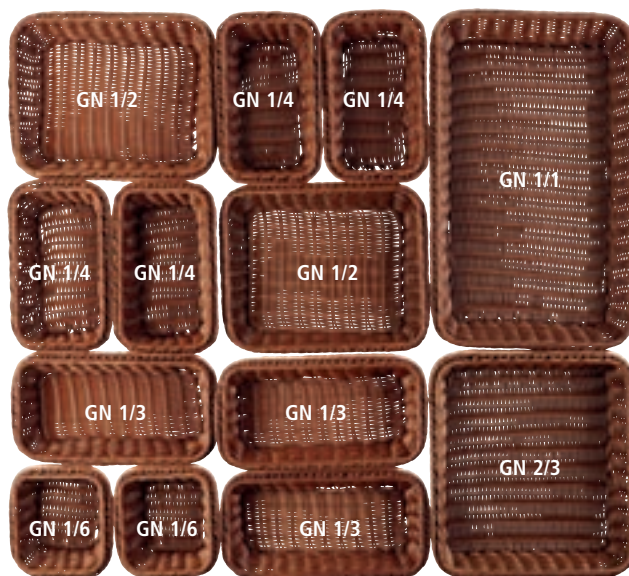

2 Höhen - 6,5 und 10 cm
2 heights - 6,5 and 10 cm



40220
GN 1/1 - 6,5 cm



40222
GN 1/2 - 6,5 cm



40228
GN 1/6 - 6,5 cm



40264
GN 1/4 - 6,5 cm



40272
GN 1/2 - 10 cm

Korb „GN LINE“

GN basket
GN cesta
GN corbeille



stabile Ausführung mit Edelstahldraht im Rand zur Stabilisierung
very solid with stainless steel wire frame to stabilize the basket
muy resistente con refuerzo de alambre inox
très résistante avec son fil de renfort inox

	cm	↑ cm	GN	Farbe / Colour
40220	53 x 32,5	6,5	1/1	■
40222	32,5 x 26,5	6,5	1/2	■
40224	32,5 x 17,6	6,5	1/3	■
40226	26,5 x 16,2	6,5	1/4	■
40228	17,6 x 16,2	6,5	1/6	■
40230	32,5 x 35,4	6,5	2/3	■
	cm	↑ cm	GN	Farbe / Colour
40240	53 x 32,5	10	1/1	■
40242	32,5 x 26,5	10	1/2	■
40244	32,5 x 17,6	10	1/3	■
40246	26,5 x 16,2	10	1/4	■
40248	17,6 x 16,2	10	1/6	■
40250	32,5 x 35,4	10	2/3	■
	cm	↑ cm	GN	Farbe / Colour
40260	53 x 32,5	6,5	1/1	■
40262	32,5 x 26,5	6,5	1/2	■
40263	32,5 x 17,6	6,5	1/3	■
40264	26,5 x 16,2	6,5	1/4	■
40266	17,6 x 16,2	6,5	1/6	■
40268	32,5 x 35,4	6,5	2/3	■
	cm	↑ cm	GN	Farbe / Colour
40270	53 x 32,5	10	1/1	■
40272	32,5 x 26,5	10	1/2	■
40274	32,5 x 17,6	10	1/3	■
40276	26,5 x 16,2	10	1/4	■
40278	17,6 x 16,2	10	1/6	■
40280	32,5 x 35,4	10	2/3	■

ECONOMIC



Tisch- und Buffetkorb, rund „ECONOMIC“

buffet basket, round
cesta de bufé redonda
corbeille de buffet ronde



	Ø cm	↑ cm	Farbe / Colour
40132	19,0	9,5	
40135	25,5	8,5	
40144	39,0	10,0	
40191	19,0	9,5	
40192	25,5	8,5	



Tisch- und Buffetkorb, oval „ECONOMIC“

buffet basket, oval
cesta de bufé oval
corbeille de buffet ovale



	cm	↑ cm	Farbe / Colour
40137	23,0 x 17,0	8,0	
40139	28,5 x 17,0	8,5	
40146	37,0 x 27,5	9,0	
40193	23,0 x 17,0	8,0	
40194	28,5 x 17,0	8,5	



Tisch- und Buffetkorb, eckig „ECONOMIC“

buffet basket rectangular
cesta de bufé rectangular
corbeille de buffet rectangulaire



	cm	↑ cm	Farbe / Colour
40140	23,0 x 17,0	8	
40159	31,5 x 22,0	8,5	
40154	30,0 x 24,5	8	
40195	23,0 x 17,0	8	
40196	31,5 x 22,0	8,5	



GN Buffetkorb „ECONOMIC“

GN basket
GN cesta
GN corbeille



	cm	↑ cm	GN	Farbe / Colour
40152	32,5 x 26,5	8	1/2	
40148	53,0 x 32,5	8	1/1	



Buffet- und Auslagekorb „ECONOMIC“

buffet basket
cesta de bufé
corbeille de buffet



	cm	↑ cm	Farbe / Colour
40161	50,0 x 25,0	6	
40160	50,0 x 20,0	6	



Buffetkorb „ECONOMIC“

buffet basket
cesta de bufé
corbeille de buffet



stabile Ausführung mit Edelstahldraht im Rand zur Stabilisierung
very solid with stainless steel wire frame to stabilize the basket
muy resistente con refuerzo de alambre inox
très résistante avec son fil de renfort inox

	cm	↑ cm	GN
40129	53 x 32,5	15,5	1/1

GN Kuppelhaube / GN cover / GN cúpula / GN cloche bombée

	cm	↑ cm
11027	54 x 33	20



Buffetkorb „ECONOMIC“

buffet basket
cesta de bufé
corbeille de buffet



stabile Ausführung mit Edelstahldraht im Rand zur Stabilisierung
very solid with stainless steel wire frame to stabilize the basket
muy resistente con refuerzo de alambre inox
très résistante avec son fil de renfort inox

	cm	↑ cm
40153	45 x 42	17 / 24



Buffetkorb, rund „ECONOMIC“

buffet basket, round
cesta de bufé redonda
corbeille de buffet ronde



stabile Ausführung mit Edelstahldraht im Rand zur Stabilisierung
very solid with stainless steel wire frame to stabilize the basket
muy resistente con refuerzo de alambre inox
très résistante avec son fil de renfort inox

	Ø cm	↑ cm	Farbe / Colour
40149	40	12,5	
40295	40	12,5	

Rolltophaube / rolltop cover / campana abatible / cloche basculante

	Ø cm	↑ cm	
18388	38	20	mit verchromtem Kugelgriff with chrome plated handle con pomo cromado / avec bouton chromé
18387	38	20	mit vergoldetem Kugelgriff / gold plated handle pomo dorado / bouton doré
18389	38	20	mit verchromtem Designergriff / with chrome plated designer handle

Körbe



Buffetkorb „ECONOMIC“

buffet basket
cesta de bufé
corbeille buffet



in Handarbeit geflochten, stabile Ausführung, Edelstahl Fixierungsrahmen, zur Rutschsicherung, ohne Haube

wickerwork, stainless steel fix the cover, without cover

cesta trensada a mano, con marco cromado patentado para fijar y encajar la campana (se entrega sin la campana)

corbeille tressée main, cadre fil acier inoxydable pour fixer la cloche (livré sans la cloche)

	cm	↑ cm	Farbe / Colour
40150	56,5 x 36	10	
40294	56,5 x 36,0	10,0	

GN 1/1 Rolltop-Haube / GN 1/1 rolltop cover / GN 1/1 campana abatible

GN 1/1 cloche basculante

	cm	↑ cm	GN	
11008	53,0 x 32,5	19	1/1	vergoldeter Griff / gold plated handle pomo dorado / bouton doré
11010	53,0 x 32,5	19	1/1	verchromter Griff / chrome plated handle pomo cromado / bouton chromé
11018	53,0 x 32,5	17	1/1	mit verchromtem Designergriff with chrome plated designer handle



GN Kuppelhaube

GN cover
GN cúpula
GN cloche bombée



glasklarer Kunststoff, Griff verchromt

clear, chrome knob

transparente, asa cromada

transparente, anse chromée

	cm	↑ cm	GN	
11021	33 x 28	17	1/2	geschlossen / totally closed cerrada / totalmente fermée
11022	33 x 28	17	1/2	mit Front-Ausschnitt / one long side cut out gran apertura frontal grande ouverture frontale
11026	54 x 33	20	1/1	geschlossen / totally closed cerrada / totalement fermée
11027	54 x 33	20	1/1	mit Front-Ausschnitt / one long side cut out gran apertura frontal grande ouverture frontale
11028	54 x 33	20	1/1	mit seitlichem Ausschnitt one small side cut out pequeña apertura lateral petite ouverture latérale



Buffetgestell für Körbe
buffet stand for baskets
expositor para cestas
support métal pour corbeilles

2-stufig, für 2 rechteckige Körbe, platzsparend zusammenklappbar, Lieferung ohne Körbe
2-tier, for 2 rectangular baskets, can be folded, place saving, delivery without baskets
2 alturas, para 2 cestas rectangulares, totalmente plegable para ahorrar espacio, se entrega sin cestas
2 hauteurs, pour 2 corbeilles rectangulaires, pliable pour son rangement, livré sans corbeilles



40222



40262

	cm	↑ cm
33221	46 x 24	18 - 21

Tisch- und Buffetkorb rechteckig „BASIC“ / buffet basket / cesta de bufé / corbeille de buffet

	cm	↑ cm	Farbe / Colour
30286	30,0 x 22,0	7	
30288	41,0 x 29,0	7	

Tisch- und Buffetkorb eckig „ECONOMIC“ / buffet basket rectangular / cesta de bufé rectangular / corbeille de buffet rectangulaire

	cm	↑ cm	Farbe / Colour
40154	30,0 x 24,5	8	
40159	31,5 x 22,0	8,5	
40161	50,0 x 25,0	6	

Korb „GN LINE“ / GN basket / GN cesta / GN corbeille

	cm	↑ cm	Farbe / Colour
40222	32,5 x 26,5	6,5	
40242	32,5 x 26,5	10	
40262	32,5 x 26,5	6,5	
40272	32,5 x 26,5	10	

Buffetgestell „DOPPELDECKER“ für GN
buffet frame for GN
estructura para bufé para GN
support buffet pour GN



2-teilig, einfach zusammensetzbar, Etagen-Abstand ca. 26 cm, platzsparend, stabile Ausführung
pcs. frame, easy to assemble, distance between the tiers approx 26 cm, space-saving, robust
2 piezas, fácil de montar, distancia entre pisos aprox. 26 cm, robusto
2 étages, distance entre niveaux approx. 26 cm, robuste



	cm	↑ cm	fits to GN
11555	50 x 34	37,5	1/1
11553	29 x 27	35	1/2

Körbe



Baguettekorb „ECONOMIC“

baguette basket
cesta para baguette
corbeille pour baguettes



stabile Ausführung mit Edelstahldraht im Rand zur Stabilisierung
very solid with stainless steel wire frame to stabilize the basket
muy resistente con refuerzo de alambre inox
très résistante avec son fil de renfort inox

	Ø cm	↑ cm	Farbe / Colour
40198	35	25 / 42	
40199	35	25 / 42	



Brot- und Obstkorb „ECONOMIC“

basket for bread or fruits
cesta para pan o fruta
corbeille à pain ou à fruits



	Ø cm	↑ cm
40125	23	7



Brot- und Obstkorb „ECONOMIC“

basket for bread or fruits
cesta para pan o fruta
corbeille à pain ou à fruits



	cm	↑ cm
40127	27 x 20	10



Besteckkorb „ECONOMIC“

cutlery dispenser
dispensador de cubiertos
corbeille à couverts



4 Fächer, 3 kleine Fächer, 1 großes Fach
4 troughs
4 huecos
4 classements

	cm	↑ cm	Farbe / Colour
40179	26 x 18	15	
40182	26 x 18	15	



Besteckkorb „ECONOMIC“
cutlery dispenser
dispensador de cubiertos
corbeille à couverts



in Handarbeit geflochten
wickerwork
trensado a mano
tressage à main

	Ø cm	↑ cm	Farbe / Colour
40130	12	15	
40007	12	15	
40012 <small>NEW</small>	12	15	
40013 <small>NEW</small>	12	15	



Besteckkorb „ECONOMIC“
cutlery dispenser
dispensador de cubiertos
corbeille à couverts



in Handarbeit geflochten
wickerwork
trensado a mano
tressage à main

	cm	↑ cm	Farbe / Colour
40131	27 x 10	4,5	
40009	27 x 10	4,5	
40010 <small>NEW</small>	27 x 10	4,5	
40011 <small>NEW</small>	27 x 10	4,5	



Besteckkorb „ECONOMIC“
cutlery dispenser
dispensador de cubiertos
corbeille à couverts



	Ø cm	↑ cm
40286	12	15



Besteckkorb „ECONOMIC“
cutlery dispenser
dispensador de cubiertos
corbeille à couverts



	cm	↑ cm
40287	12 x 12	15

BASIC

- in Handarbeit geflochten, einfache und leichte Ausführung
- wickerwork, simple and light version
- ligera, trensada a mano
- tressé à main, version légère



Brot- und Obstkorb oval „BASIC“

basket for bread or fruits
cesta para pan o fruta
corbeille à pain ou à fruits



	cm	↑ cm
30279	18 x 12	7
30280	23 x 15	6



Brot- und Obstkorb oval „BASIC“

basket for bread or fruits
cesta para pan o fruta
corbeille à pain ou à fruits



	cm	↑ cm
30282	21 x 10	6
30284	36 x 15	7



Brot- und Obstkorb rund „BASIC“

basket for bread or fruits
cesta para pan o fruta
corbeille à pain ou à fruits



	Ø cm	↑ cm
30281	20	7
30285	25	7



Tisch- und Buffetkorb rechteckig „BASIC“

buffet basket
cesta de bufé
corbeille de buffet



	cm	↑ cm
30286	30,0 x 22,0	7
30288	41,0 x 29,0	7
30283	22,0 x 15,0	6



Brot- und Obstkorb quadratisch „BASIC“

basket for bread or fruits
cesta para pan o fruta
corbeille à pain ou à fruits



	cm	↑ cm
30287	24 x 24	6

WICKER LOOK



sehr formstabil, Kunststoff gespritzt



40213
Ø 20 cm



40234
Ø 20 cm



40235
Ø 20 cm



40236
23 x 17 cm



40216
23 x 17 cm



40211
39,5 x 29,5 cm

Brot- und Obstkorb „WICKER LOOK“

basket for bread or fruits
cesta para pan o fruta
corbeille à pain ou à fruits



	Ø cm	↑ cm	Farbe / Colour
40213	20	6,5	
40214	20	6,5	
40234	20	6,5	
40235	20	6,5	

	cm	↑ cm	Farbe / Colour
40215	23 x 17	6,5	
40216	23 x 17	6,5	
40236	23 x 17	6,5	
40237	23 x 17	6,5	

	cm	↑ cm	Farbe / Colour
40211	39,5 x 29,5	10	
40212	39,5 x 29,5	10	
40210	39,5 x 29,5	10	

Körbe



Brottasche

bread basket
panera
corbeille à pain en toile

BAUM-
WOLLE
COTTON

Baumwolle, umgekrempelt kann die Höhe individuell gestaltet werden, maschinenwaschbar bis 30°C, rund oder oval
cotton, adjustable height, mashine-washable 30°C, round or oval
algodón, altura ajustable, lavable a máquina 30°C, redondo u oval
coton, hauteur ajustable, lavable en machine maxi 30°C, rond ou ovale

	Ø cm	↑ cm	Farbe / Colour
30340	17	8	
30350	20	9	
30341	17	8	
30351	20	9	



Brottasche

bread basket
panera
corbeille à pain en toile

BAUM-
WOLLE
COTTON

Baumwolle, umgekrempelt kann die Höhe individuell gestaltet werden, maschinenwaschbar bis 30°C, rund oder oval
cotton, adjustable height, mashine-washable 30°C, round or oval
algodón, altura ajustable, lavable a máquina 30°C, redondo u oval
coton, hauteur ajustable, lavable en machine maxi 30°C, rond ou ovale

	cm	↑ cm	Farbe / Colour
30360	20 x 15	7	
30370	25 x 18	9	
30361	20 x 15	7	
30371	25 x 18	9	



Brottasche

bread basket
panera
corbeille à pain en toile

BAUM-
WOLLE
COTTON

Baumwolle, umgekrempelt kann die Höhe individuell gestaltet werden, maschinenwaschbar bis 30°C, rund oder oval
cotton, adjustable height, mashine-washable 30°C, round or oval
algodón, altura ajustable, lavable a máquina 30°C, redondo u oval
coton, hauteur ajustable, lavable en machine maxi 30°C, rond ou ovale

	Ø cm	↑ cm	Farbe / Colour
30342	17	8	
30352	20	9	
30343	17	8	
30353	20	9	



Brottasche

bread basket
panera
corbeille à pain en toile

BAUM-
WOLLE
COTTON

Baumwolle, umgekrempelt kann die Höhe individuell gestaltet werden, maschinenwaschbar bis 30°C, rund oder oval
cotton, adjustable height, mashine-washable 30°C, round or oval
algodón, altura ajustable, lavable a máquina 30°C, redondo u oval
coton, hauteur ajustable, lavable en machine maxi 30°C, rond ou ovale

	cm	↑ cm	Farbe / Colour
30362	20 x 15	7	
30372	25 x 18	9	
30363	20 x 15	7	
30373	25 x 18	9	



Brot- und Obstkorb inklusive Brottasche

basket for bread or fruits
cesta para pan o fruta
corbeille à pain ou à fruits

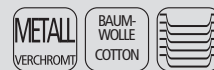

mit Baumwoll-Einleger, maschinenwaschbar bis 30°C
with cotton-inliner, mashine-washable 30°C
algodón, lavable a máquina 30°C
coton, lavable en machine maxi 30°C

	Ø cm	↑ cm	Farbe / Colour
30203	20	9	
30204	23	9	



Brottasche mit Wärmekissen

bread basket with stones pillow
panera con cojin
corbeille à pain entoile



Baumwolle, Keramik-Kugeln
cotton, ceramic stones
algodón
coton

	Ø cm	↑ cm	Farbe / Colour
30380	20	23,5	
30390	20	23,5	

Wärmekissen / stones pillow / cojín de piedrecillas a calentar / coussin de petites pierres, à chauffer

	Ø cm	↑ cm	Farbe / Colour
30385	19	1,5	



Eierkorb „PROFI LINE“

eggs basket
cesta de huevos
panier à oeufs



mit Edelstahldraht im Rand, für ca. 20 Eier, hält den Inhalt durch das Stoff-Futter lange warm
willow, stable, for around 20 eggs, keeps eggs warm
ratán, calidad fuerte, para unos 20 huevos, mantiene los huevos calientes
rotin, résistant, belle qualité, pour environ 20 oeufs, pour maintenir les oeufs bien chauds

	Ø cm	↑ cm	Farbe / Colour
40299	26	17	



Eierkorb

egg basket
cesta de huevos
panier à oeufs



stabile Vollweide, für ca. 20 Eier, hält den Inhalt durch das Stoff-Futter lange warm
willow, stable, for around 20 eggs, keeps eggs warm
ratán, calidad fuerte, para unos 20 huevos, mantiene los huevos calientes
rotin, résistant, belle qualité, pour environ 20 oeufs, pour maintenir les oeufs bien chauds

	Ø cm	↑ cm	Farbe / Colour
30299	26	17	

PAPERBAGS



Brottasche „PAPERBAG“

bread basket

panera

corbeille

robustes Kraftpapier

robust kraft paper

robusto papel kraft

papier kraft robuste

PAPIER
PAPER



	Ø cm	↑ cm	Farbe / Colour	
30440	17	11		Tischkorb / table size
30450	20	13		Tischkorb / table size
30442	24	24		Buffetkorb / buffet size
30443	30	22		Buffetkorb / buffet size
30441	17	11		Tischkorb / table size
30451	20	13		Tischkorb / table size
30445	24	24		Buffetkorb / buffet size
30446	30	22		Buffetkorb / buffet size



Brottasche „PAPERBAG“

bread basket

panera

corbeille

robustes Kraftpapier

robust kraft paper

robusto papel kraft

papier kraft robuste

PAPIER
PAPER



	cm	↑ cm	Farbe / Colour
30444	30 x 20	18	
30447	30 x 20	18	

NEW



30273

Brot- und Obstkorb „STRIPES“

basket for bread or fruits
cesta para pan o fruta
corbeille à pain ou fruits

außen hochglanzpoliert, innen matt
outside mirror polished finish, inside matt
exterior acabado pulido brillante, interior mate
extérieur brillant, intérieur pâle



	Ø cm	↑ cm
30273	17	5
30274	20	6



30310

Brot- und Obstkorb

basket for bread or fruits
cesta para pan o fruta
corbeille à pain ou fruits



	Ø cm	↑ cm
30310	18	7,5
30320	23	9



30276

Brot- und Obstschale

bowl for bread or fruits
bol para pan o frutas
bol à pain ou à fruits

hochglanzpoliert, Hammerschlag Optik
mirror polished finish, hammered look
acabado pulido efecto espejo, aspecto repujado
brillant, aspect martelé



	Ø cm	↑ cm
30276	16	5
30277	20	5,5

hot price



40110

Edelstahl-Schale

bowl
bandeja ovalada inox
corbeille ovale inox

engerollter Rand
rolled edge
borde redondeado
bord roulé



	cm	↑ cm
40110	26,5 x 18,5	4,0
40115	31,0 x 21,0	4,5



30220

Brot- und Obstkorb

basket for bread or fruits
cesta para pan o fruta
corbeille à pain ou à fruits

hochglanzpoliert
mirror polished finish
acabado pulido brillante
brillant



	Ø cm	↑ cm
30200	17,5	7
30220	20,5	8,5
30230	25,5	9,5

Körbe



Brot- und Obstkorb

basket for bread or fruits
cesta para pan o fruta
corbeille à pain ou à fruits

EDELSTAHL
STAINLESS
INOX
18/8



hochglanzpoliert
mirror polished finish
acabado pulido brillante
brillant

	cm	↑ cm
30210	20 x 15	7
30240	24 x 19	8,5
30250	28 x 21	9,5



Obstkorb

basket for fruits
cesta para fruta
corbeille à fruits

EDELSTAHL
STAINLESS
INOX
18/8



hochglanzpoliert
mirror polished finish
acabado brillante
brillant

	∅ cm	↑ cm
30270	21,5	20,5



Brot- und Obstkorb mit Tragegriff

basket for bread or fruits
cesta para pan o fruta
corbeille à pain ou à fruits

EDELSTAHL
STAINLESS
INOX



	cm	↑ cm	Farbe / Colour
30201	24 x 24	21	
30202	24 x 24	21	



Etagère

etagère
frutero
corbeille à fruits

METALL
VERCHROMT



ergonomischer Griff, stehend auf schwarzen Antirutsch-Füßen
ergonomic handle, anti-slip-feets
asa ergonómica, pies antideslizantes color negro
anse ergonomique, pieds antidérapants noirs

	cm	↑ cm
30325	30 x 30	35,5



Buffetständer / -korb „ASIA PLUS“

buffet stand / basket
soporte para bufé / cestas
présentoir buffet / corbeilles



	Ø cm	↑ cm	Farbe / Colour
15507	15	10,5	—
15510	15	10,5	■



Buffetständer / -korb „ASIA PLUS“

buffet stand / basket
soporte para bufé / cestas
présentoir buffet / corbeilles



	Ø cm	↑ cm	Farbe / Colour
15508	21	10,5	—
15511	21	10,5	■



Buffetständer / -korb „ASIA PLUS“

buffet stand / basket
soporte para bufé / cestas
présentoir buffet / corbeilles



	Ø cm	↑ cm	Farbe / Colour
15509	21	20	—
15512	21	20	■

Körbe



Korb / Ständer „BASKET“
 basket / riser
 cesta / soporte
 corbeille / support

METALL

	Ø cm	↑ cm	Farbe / Colour
15321	21 / 15	11	
15325	21 / 15	11	
15323	21 / 15	11	



Korb / Ständer „BASKET“
 basket / riser
 cesta / soporte
 corbeille / support

METALL

	Ø cm	↑ cm	Farbe / Colour
15320	10,5 / 8	8	
15324	10,5 / 8	8	
15322	10,5 / 8	8	



Korb / Ständer „BASKET“
 basket / riser
 cesta / soporte
 corbeille / support

Chrom poliert
 polished chrome
 color plata brillante
 chrome poli

METALL

	Ø cm	↑ cm	Farbe / Colour
15331	15	10,5	
15332	21	20	



Korb / Ständer „BASKET“
 basket / riser
 cesta / soporte
 corbeille / support

Gold, gebürstet
 brushed gold
 dorado cepillado
 doré brossé

METALL

	Ø cm	↑ cm	Farbe / Colour
15334	15	10,5	
15335	21	20	



Korb / Ständer „BASKET“

basket / riser
cesta / soporte
corbeille / support



	Ø cm	↑ cm	Farbe / Colour
15326	21 / 15	21	■



Box „BROTSTATION“

box
caja de pan para el bufé
boîte à pain pour le buffet



Buchen-Holz
beech
haya
hêtre

	cm	↑ cm
00959	34 x 26	12,5
00954	34 x 26	20,0

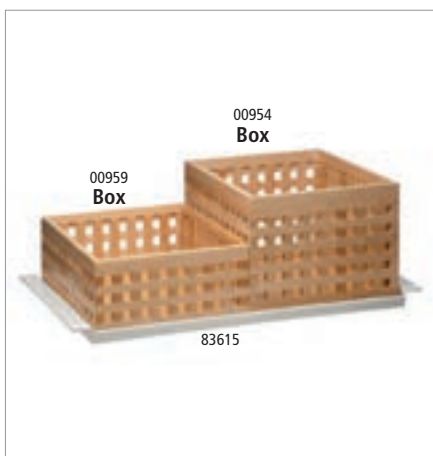

Tablett „BROTSTATION“

tray
bandeja
plateau



Antirutsch-Füßchen
non-slip feet
pies antideslizantes
pieds antiglisse

	cm	↑ cm
83615	59,5 x 35,5	3,5



Brot Schneidebrett „BROTSTATION“

cutting board
tabla de corte
planche à découper



Buchen-Holz
beech
haya
hêtre

	cm	↑ cm
00953	52 x 34	2

URBAN



In den Cafés der Metropolen waren sie schon immer präsent. Jetzt verhelfen wir den schwarzen, einfachen Metallkörben über die Stadtgrenzen hinaus die Buffets der Welt zu erobern. Klassische und außergewöhnliche Größenverhältnisse machen die Artikel zu einer „must-have“-Serie. Nie war Food-Präsentation aktueller als mit URBAN.

They have always been present in the cafes of the metropolises. Now we are helping the black, simple metal baskets beyond the city limits to conquer the buffets all over the world. Classic and exceptional sizes make the articles to be a must-have series. Food presentation has never been more actual than with the series URBAN.

Siempre han estado presentes en los cafés de las grandes ciudades. Ahora ayudamos a las cestas de metal negras y simples a llegar más allá de los límites de la ciudad y a conquistar los buffets del mundo. Los tamaños clásicos y excepcionales hacen de los artículos una serie imprescindible. La presentación de alimentos nunca ha sido más actual que con la serie URBAN.

Ils ont toujours été présents dans les cafés des métropoles. Maintenant, nous aidons les corbeilles en métal noir et simple au-delà des limites de la ville pour conquérir les buffets du monde. Les tailles classiques et exceptionnelles font des articles une série indispensable. La présentation de la nourriture n'a jamais été plus actuelle qu'avec la série URBAN.





Korb „URBAN“
basket
cesta
corbeille



	Ø cm	↑ cm	Farbe / Colour
30410	17	7	■
30411	20	8,5	■



Korb „URBAN“
basket
cesta
corbeille



	cm	↑ cm	Farbe / Colour
30412	21 x 10	7	■
30413	30 x 14	12	■



GN Korb „URBAN“
GN basket
GN cesta
GN corbeille



	cm	↑ cm	GN	Farbe / Colour
30414	53,0 x 32,5	7,5	1/1	■
30415	32,5 x 26,5	7,5	1/2	■
30416	53,0 x 16,2	7,5	2/4	■

GN Kuppelhaube / GN cover / GN cúpula / GN cloche bombée

	cm	↑ cm	GN
11027	54 x 33	20	1/1

GN Abdeckhaube / GN cover / GN cubierta / GN cloche

	cm	↑ cm	GN
11042	53,0 x 32,5	9,5	1/1





Chafing Dish, GN Container & Transport

Chafing Dish
Suppentöpfe
Heizelemente
GN-Behälter
Thermo-Boxen

chafing dish
marmitas de sopa
resistencias
GN cubetas
Thermo-Box

chafing dish
soup warmers
heating units
GN-container
Thermo-Box

chafing dish
marmites à soup
résistances
GN bacs
Thermo-Box

EASY INDUCTION



die Deckelbremse sorgt für langsames Schließen

the revolving cover closes gently, thanks to a special built-in axle

sistema de freno para un cierre suave de la tapa

système avec frein pour une fermeture en douceur du couvercle



Druckhebel zum leichten Entnehmen des GN-Behälters

stick for easy removing of the GN-container

dispositivo para levantar y quitar con facilidad la cubeta GN

dispositif pour lever et retirer facilement le bac GN



abnehmbarer Glas-Deckel mit Wasserrücklaufsystem

removable glass lid, with water-runback-system

tapa transparente desmontable con sistema de retorno de la condensación

couvercle transparent amovible avec système de retour de la condensation



Fixierschraube verhindert das Rutschen

fixing screw for skid resistance

Pie trasero anti-deslizante, altura regulable

Pied supplémentaire anti-dérapant réglable en hauteur

NEW



Lieferung ohne Induktionskochplatte
delivery without induction plate
se entrega sin placa de inducción
livré sans plaque à induction

GN 1/1 Chafing Dish „EASY INDUCTION“



1 Gestell + 1 Wasserbecken mit Sandwichboden + 1 Deckel mit hydraulischem Gelenk + 1 GN 1/1 Behälter 65 mm tief, hitzebeständige Griffe, hochwertige Verarbeitung, ausschließlich für Induktionskochfelder

1 frame + 1 waterpan with sandwich base + 1 hydraulic cover + 1 GN 1/1 container 65 mm, heat-resistant handles, high quality, only for induction plates

1 marco + 1 baño maría con base sandwich + 1 marco con tapa hidráulica + 1 cubeta GN 1/1 pan 65 mm profundo, asas resistentes al calor, buenos acabados, solamente para inducción

1 pied support + 1 bac bain-marie avec fond sandwich + 1 cadre avec couvercle hydraulique + 1 bac GN 1/1 - 65mm, poignées résistantes à la chaleur, belle qualité, uniquement pour induction

	cm	↑ cm	GN	ltr.
12322	60 x 42	30	1/1	9



NEW



Lieferung ohne Induktionskochplatte
delivery without induction plate
se entrega sin placa de inducción
livré sans plaque à induction

GN 2/3 Chafing Dish „EASY INDUCTION“



1 Gestell + 1 Wasserbecken mit Sandwichboden + 1 Wasserbeckenrahmen + 1 Deckel mit hydraulischem Gelenk + 1 GN 1/1 Behälter 65 mm tief, hitzebeständige Griffe, hochwertige Verarbeitung, ausschließlich für Induktionskochfelder

1 frame + 1 waterpan with sandwich base + 1 frame for waterpan + 1 hydraulic cover + 1 GN 1/1 container 65 mm, heat-resistant handles, high quality, only for induction plates

1 marco + 1 baño maría con base sandwich + 1 marco con tapa hidráulica + 1 cubeta GN 1/1 pan 65 mm profundo, asas resistentes al calor, buenos acabados, solamente para inducción

1 pied support + 1 bac bain-marie avec fond sandwich + 1 cadre avec couvercle hydraulique + 1 bac GN 1/1 - 65mm, poignées résistantes à la chaleur, belle qualité, uniquement pour induction

	cm	↑ cm	GN	ltr.
12323	42 x 41	30	2/3	5,5

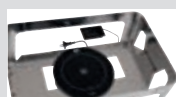



NEW

Lieferung ohne Induktionskochplatte
delivery without induction plate
se entrega sin placa de inducción
livré sans plaque à induction

Chafing Dish „EASY INDUCTION“



1 Gestell + 1 Wasserbecken mit Sandwichboden + 1 Deckel mit hydraulischem Gelenk + 1 runder Speisenbehälter, hitzebeständige Griffe, hochwertige Verarbeitung, ausschließlich für Induktionskochfelder geeignet

1 frame + 1 waterpan with sandwich base + 1 hydraulic cover + 1 round foodpan, heat-resistant handles, high quality, good for induction plates

1 soporte + 1 baño maría con base sandwich + 1 tapa hidráulica + 1 cubeta redonda, asas resistente al calor, buen acabado, apto para inducción

1 pied support + 1 bac bain-marie avec fond sandwich + 1 cadre avec couvercle hydraulique + 1 bac rond, poignées résistantes à la chaleur, belle qualité, uniquement pour induction

	cm	↑ cm	ltr.
12324	46 x 50	30	6



NEW

Lieferung ohne Induktionskochplatte
delivery without induction plate
se entrega sin placa de inducción
livré sans plaque à induction

Chafing Dish „EASY INDUCTION“



1 Gestell + 1 Wasserbecken mit Sandwichboden + 1 Deckel mit hydraulischem Gelenk + 1 runder Speisenbehälter, hitzebeständige Griffe, hochwertige Verarbeitung, ausschließlich für Induktionskochfelder geeignet

1 frame + 1 waterpan with sandwich base + 1 hydraulic cover + 1 round foodpan, heat-resistant handles, high quality, good for induction plates

1 soporte + 1 baño maría con base sandwich + 1 tapa hidráulica + 1 cubeta redonda, asas resistente al calor, buen acabado, apto para inducción

1 pied support + 1 bac bain-marie avec fond sandwich + 1 cadre avec couvercle hydraulique + 1 bac rond, poignées résistantes à la chaleur, belle qualité, uniquement pour induction

	cm	↑ cm	ltr.
12325	48 x 42	39	11



Induktionskochplatte für Chafing Dish

induction plate for chafing dish
placa de inducción para chafing dish
plaque à induction pour chafing dish

mit Regler
with power control
con control de potencia
avec régulateur

	Ø cm	
12295	24	900 W



hot price

82210

82215
2 x 2 ltr.

Porzellan-Einsatz

porcelain insert
bandeja de porcelana
bac supérieur en porcelaine



	Ø cm	↑ cm	ltr.	fits to
82210	39	6	4,3	12324
82215	39	6	4,0	12324

PREMIUM



langlebige Deckelbremse
Abnehmbarer Deckel, dieser lässt sich spielend leicht öffnen und schliessen, der Lauf des Deckels wird professionell gedämpft.



Kondenswasser - Rücklaufsystem
Kondenswasser wird in das Wasserbecken zurückgeführt.



Sandwichboden / Kapselboden
Induktionsfähiger Boden, direkt auf dem Induktionskochfeld einsetzbar. Perfekte Wärmeverteilung und Steuerung.



Fixierschraube / Rutschsicherung
Höhenverstellbares Gelenk, fixiert das Gerät in dem Gestell und auf dem Tisch.



Induktionskochplatte Nr. 12295
Induktionskochplatte wird einfach in das Gestell gelegt.



stapelbar
Chafing Dish Rahmen sind übereinander stapelbar. Platzsparend und rutschfest stapeln und transportieren.



Induktionskochplatte für Chafing Dish

induction plate for chafing dish
placa de inducción para chafing dish
plaque à induction pour chafing dish

mit Regler
with power control
con control de potencia
avec régulateur

..... Ø cm		
12295	24	900 W



Lieferung ohne Induktionskochplatte
delivery without induction plate
se entrega sin placa de inducción
livré sans plaque à induction

GN 1/1 Chafing Dish „PREMIUM“



1 Gestell + 1 Wasserbecken mit Sandwichboden + 1 Wasserbeckenrahmen + 1 Deckel mit hydraulischem Gelenk + 1 GN 1/1 Behälter 65 mm tief, hitzebeständige Griffe, hochwertige Verarbeitung, ausschließlich für Induktionskochfelder

1 frame + 1 waterpan with sandwich base + 1 frame for waterpan + 1 hydraulic cover + 1 GN 1/1 container 65 mm, heat resistant handles, high quality, only for induction plates
1 soporte + 1 cubeta baño maría con base sandwich + 1 marco para cubeta baño maría + 1 tapa hidráulica + 1 cubeta GN 1/1 de 65 mm, asas resistentes al calor, acabado de alta calidad, solamente para inducción
1 pied support + 1 bac bain-marie avec fond sandwich + 1 cadre pour bac bain-marie + 1 couvercle hydraulique + 1 bac GN 1/1 de 65 mm, poignées résistantes à la chaleur, finition de qualité, uniquement pour induction

	cm	↑ cm	ltr.	
12370	66 x 48	33	9	mit Edelstahldeckel with stainless cover
12352	66 x 48	33	9	mit Glasdeckel with glass cover



Lieferung ohne Induktionskochplatte
delivery without induction plate
se entrega sin placa de inducción
livré sans plaque à induction

Chafing Dish rund „PREMIUM“



1 Gestell + 1 Wasserbecken mit Sandwichboden + 1 Wasserbeckenrahmen + 1 Deckel mit hydraulischem Gelenk + 1 runder Speisenbehälter, hitzebeständiger Griff, hochwertige Verarbeitung, für Induktionskochfelder geeignet

1 frame + 1 waterpan with sandwich base + 1 frame for waterpan + 1 hydraulic cover + 1 round foodpan, heat resistant handle, high quality, suitable for induction plates
1 soporte + 1 cubeta baño maría con base sandwich + 1 marco para cubeta baño maría + 1 tapa hidráulica + 1 cubeta redonda, asa resistente al calor, acabado de alta calidad, apto para inducción
1 pied support + 1 bac bain-marie avec fond sandwich + 1 cadre pour bac bain-marie + 1 couvercle hydraulique + 1 bac rond, poignée résistante à la chaleur, finition de qualité, apte pour induction

	cm	↑ cm	ltr.	
12371	44 x 54	33	6	mit Edelstahldeckel with stainless cover
12353	44 x 54	33	6	mit Glasdeckel with glass cover

Speiseneinsatz / foodpan / cubeta / bac supérieur

12366



Lieferung ohne Induktionskochplatte
delivery without induction plate
se entrega sin placa de inducción
livré sans plaque à induction

Chafing Dish rund „PREMIUM“



1 Gestell + 1 Wasserbecken mit Sandwichboden + 1 Wasserbeckenrahmen + 1 Deckel mit hydraulischem Gelenk + 1 runder Speisenbehälter, hitzebeständige Griffe, hochwertige Verarbeitung, für Induktionskochfelder geeignet

1 frame + 1 waterpan with sandwich base + 1 frame for waterpan + 1 hydraulic cover + 1 round foodpan, heat resistant handles, high quality, suitable for induction plates
1 soporte + 1 cubeta baño maría con base sandwich + 1 marco para cubeta baño maría + 1 tapa hidráulica + 1 cubeta redonda, asas resistentes al calor, acabado de alta calidad, apto para inducción
1 pied support + 1 bac bain-marie avec fond sandwich + 1 cadre pour bac bain-marie + 1 couvercle hydraulique + 1 bac rond, poignées résistantes à la chaleur, finition de qualité, apte pour induction

	cm	↑ cm	ltr.	
12372	44 x 48	39	10	mit Edelstahldeckel with stainless cover
12354	44 x 48	39	10	mit Glasdeckel with glass cover

Speisenbehälter / foodpan / cubeta superior / bac supérieur

12397

GLOBE



die Deckelbremse sorgt für langsames Schließen

the revolving cover closes gently, thanks to a special built-in axle

resistencia los frenos del sistema garantizan un cierre suave de la tapa

système avec frein pour une fermeture en douceur du couvercle



abnehmbarer Deckel mit Wasserrücklaufsystem

lid can be taken off, with water runback system

tapa fácil de desmontar, y canal incorporado para recuperar el agua condensada

couvercle facile à démonter, rainure pour récupérer les gouttes de condensation



Kondenswasser wird in das Wasserbecken zurückgeführt

condensed water is led back into the waterpan

el agua de condensación vuelve a la cubeta de agua

l'eau de condensation retourne dans le bac d'eau



für alle Herdarten geeignet, auch für Induktionskochplatten

suitable for all kinds of ovens, even induction cookers

apto para todas las fuentes de calor, incluso inducción

apte pour toutes les sources de chaleur, y compris induction



GN 1/1 Chafing Dish „GLOBE“



hochglanzpoliert, mit abnehmbarem hydraulischen Edelstahl-Deckel, Sandwichboden sorgt für optimale Wärmeleitung, für Induktionsplatten geeignet, Set: Gestell + Wasserbecken + Speisenbehälter GN 1/1 65 mm tief, 9 Liter + Löffelablage + 2 Brennpastenbehälter + Metallrahmen für Induktionskochplatte

mirror polished finish, removable stainless steel hydraulic cover, sandwich base for optimum heat distribution, suitable for induction plates

set: frame + waterpan + GN 1/1 container 65 mm, 9l + cutlery compartment ladles + 2 burner holder + frame for induction plate

pulido brillante, tapa hidráulica de acero inoxidable extraíble, fondo difusor sandwich apto para inducción, incluye: soporte + cubeta baño maría + cubeta GN 1/1 de 65 mm, 9 l + soporte para cuchara (sin cuchara) + 2 quemadores + marco para la placa de inducción

poli brillant, couvercle inox hydraulique amovible, fond diffuseur sandwich apte pour induction, comprend: pied support + bac bain-marie + bac GN 1/1 de 65 mm, 9 l + porte-louche (louche non incluse) + 2 brûleurs + cadre inox pour la plaque à induction

	cm	↑ cm	ltr.	
12394	66,5 x 44,0	34	9	mit Edelstahldeckel with stainless cover
12404	66,5 x 44,0	34	9	mit Glasdeckel with glass cover

Deckel mit Glasfenster / cover with glass insert / tapa con cristal / couvercle inox et verre

12391

Deckel Edelstahl / cover stainless steel / tapa de acero inoxidable / couvercle tout inox

12386

Induktionskochplatte für Chafing Dish / induction plate for chafing dish / placa de inducción para chafing dish / plaque à induction pour chafing dish

12295

Metallrahmen für Induktionskochplatte / frame for induction plate / estructura o marco para placa de inducción / cadre support inox pour plaque induction

12296



Suppen-Kugel inkl. Gestell „GLOBE“

soup bowl with stand
cubeta sopa con soporte
récipient à soupe avec pied



hochglanzpoliert, inkl. Speisenbehälter, 1 Brennpastenbehälter, mit einhängbarer Löffelablage, Sandwichboden sorgt für optimale Wärmeverteilung, für Induktionsplatten geeignet, einfaches Anbringen und Entfernen des Deckels, hitzeisolierende Griffe, 1 Metallrahmen für Induktionskochplatten

mirror polished finish, incl. foodpan and 1 burner holder, with fitting compartment for ladles, sandwich bottom for optimum heat distribution, gentle opening of the lid, heat-resistant handles, frame for induction plate

acabado pulido brillante, cubeta sopa inox, 1 quemador, platillo a colgar para el cucharón, fondo difusor sandwich, apto para inducción, tapa con apertura controlada, asas frías, marco para placa de inducción

poli brillant, récipient à soupe inox, 1 brûleur, repose-couvert à accrocher, fond diffuseur sandwich, apte pour induction, couvercle à ouverture contrôlée, anses froides, cadre support inox pour plaque à induction

	Ø cm	↑ cm	ltr.
12398	48	45	10

Induktionskochplatte für Chafing Dish / induction plate for chafing dish / placa de inducción para chafing dish / plaque à induction pour chafing dish

12295

Metallrahmen für Induktionskochplatten / frame for induction plate / marco para placa de inducción / cadre support inox pour plaque induction

12291



Suppen-Kugel „GLOBE“

soup bowl
cubeta sopa
récipient à soupe



hochglanzpoliert, inkl. Speisenbehälter, mit einhängbarer Löffelablage, Sandwichboden sorgt für optimale Wärmeverteilung, für Induktionsplatten geeignet, einfaches Anbringen und Entfernen des Deckels, hitzeisolierende Griffe (Lieferung ohne Gestell, Löffel)

mirror polished finish, incl. foodpan, with fitting compartment for ladles, sandwich bottom for optimum heat distribution, gentle opening of the lid, heat-resistant handles (delivery without rack, ladle)

acabado pulido brillante, cubeta sopa inox, platillo a colgar para el cucharón, fondo difusor sandwich, apto para inducción, tapa con apertura controlada, asas frías (cucharón no incluido)

poli brillant, récipient à soupe inox, repose-couvert à accrocher, fond diffuseur sandwich, apte pour induction, couvercle à ouverture contrôlée, anses froides (cadre, louche non incluse)

	Ø cm	↑ cm	ltr.
12399	48	32	10

Gestell inkl. Brenner / frame incl. burner / soporte incluyendo quemador / support, brûleur inclus

12396

Speisenbehälter / foodpan / cubeta superior / bac supérieur

12397



Chafing Dish „GLOBE“



hochglanzpoliert, mit abnehmbarem hydraulischen Edelstahl-Deckel, Sandwichboden sorgt für optimale Wärmeleitung, für Induktionsplatten geeignet

Set: Gestell + Wasserbecken + Speisenbehälter rund + Löffelablage + Brennpastenbehälter + Metallrahmen für Induktionskochplatte

mirror polished finish, removable hydraulic cover, sandwich base, optimum heat distribution: set: frame + waterpan + foodpan round + cutlery compartment ladles + burner holder + frame for induction plate

pulido brillante, con tapa hidráulica extraíble, fondo difusor sandwich apto para inducción. Incluye: 1 pie, 1 cubeta baño maría, 1 cubeta redonda, 1 soporte para cuchara (sin cuchara), 1 quemador, marco inox para la placa de inducción

brillant, couvercle hydraulique amovible, fond diffuseur sandwich apte pour induction.

Comprend: pied, cuve bain-marie, bac inox rond, porte-louche (louche non incluse), 1 brûleur, cadre inox pour la plaque à induction

	Ø cm	↑ cm	ltr.	
12393	38,5	34	6	mit Edelstahldeckel with stainless cover
12403	38,5	34	6	mit Glasdeckel with glass cover

Deckel mit Glasfenster / cover with glass insert / tapa con cristal / couvercle inox et verre

12390

Deckel Edelstahl / cover stainless steel / tapa de acero inoxidable / couvercle tout inox

12385

Induktionskochplatte für Chafing Dish / induction plate for chafing dish / placa de inducción para chafing dish / plaque à induction pour chafing dish

12295

Metallrahmen für Induktionskochplatten / frame for induction plate / marco para placa de inducción / cadre support inox pour plaque induction

12291

Speiseneinsatz / foodpan / cubeta / bac supérieur

12366



Porzellan-Einsatz

porcelain insert

bandeja de porcelana

bac supérieur en porcelaine



	Ø cm	↑ cm	ltr.	fits to
82210	39	6	4,3	12393, 12403
82215	39	6	4,0	12393, 12403



GN 2/3 Chafing Dish „GLOBE“



hochglanzpoliert, mit abnehmbarem hydraulischen Edelstahl-Deckel, Sandwichboden sorgt für optimale Wärmeleitung, für Induktionsplatten geeignet, Set: Gestell + Wasserbecken + 1 GN 2/3 Behälter 65 mm tief + Löffelablage + 1 Brennpastenbehälter + 1 Metallrahmen für Induktionskochplatte

mirror polished finish, removable hydraulic cover, sandwich base, optimum heat distribution, set: frame + waterpan + foodpan GN 2/3, 65 mm, 5,5 l + compartment for ladles + burner holder + frame for induction plate

pulido brillante, con tapa hidráulica extraíble, fondo difusor sandwich apto para inducción. Incluye: 1 pie, 1 cubeta baño maria, 1 cubeta GN 2/3 65 mm - 5,5 l, 1 soporte para cuchara (sin cuchara), 1 quemador, marco inox para la placa de inducción

poli brillante, couvercle hydraulique amovible, fond diffuseur sandwich apte pour induction. Comprend: pied, cuve bain-marie, bac inox GN 2/3-65 mm - 5,5 L, porte-louche (louche non incluse), brûleur, cadre inox pour la plaque à induction

	cm	↑ cm	ltr.	
12483	44 x 41	34	5,5	mit Edelstahl-Deckel with stainless steel cover
12484	44 x 41	34	5,5	mit Glasdeckel with glass cover



Rolltop-Chafing Dish „ELITE“



poliert, Rolltop-Deckel klappbar auf 90° und 180°, Speisenbehälter GN 1/1 65 mm tief + Wasserbecken + 2 Brennpastenbehälter, wechseln des GN-Behälters ohne abnehmen des Deckels (kein Kondenswasser-Rücklaufsystem)

polished, rolltop cover adjustable at 90° and 180°, foodpan GN 1/1 65 mm deep + waterpan + 2 burner holders, change of the GN container without removing the lid (condensed water can not be led back into the waterpan)

pulido brillante, tapa rolltop a 90° o 180°, cubeta GN 1/1 + 2 quemadores, cuba baño maría, se puede cambiar la cubeta GN sin retirar la tapa, importante: el agua condensada no revierte en los alimentos

poli brillant, couvercle rolltop ouverture de 90 a 180°, bac GN 1/1, bain-marie, 2 brûleurs, le bac GN peut être retiré et remplacé sans démonter le couvercle, important: la condensation ne retombe pas sur les aliments

	cm	↑ cm	ltr.
12350	67 x 47	45	9

Wasserbecken inkl. Vorrichtung für Heizelement / waterpan / baño maría / bain-marie

12249



inkl. Vorrichtung für Heizelement
incl. screws for heating unit



Rolltop-Chafing Dish „MAESTRO“



Speisenbehälter GN1/1 65 mm tief (passend auch für 100 mm) + Rolltop-Deckel 90° + Wasserbecken inkl. Vorrichtung für Heizplatte + 2 Brennpastenbehälter

foodpan GN1/1 65 mm (also for 100 mm) + rolltop cover 90° + waterpan with screws for heating unit + 2 burner holders

cubeta GN 1/1 - 65 mm (hay espacio para una cubeta 100 mm) + campana rolltop abatible a 90° + 2 quemadores

bac GN 1/1 - 65 mm (accepte aussi bac ht. 100 mm) + couvercle rolltop ouverture 90° + 2 brûleurs

	cm	↑ cm	ltr.
12300	67 x 35	45	9



Rolltop-Chafing Dish „WINDOW“



poliert, Rolltop-Deckel klappbar auf 90° und 180°, Speisenbehälter 65 mm tief + Wasserbecken + 2 Brennpastenbehälter, wechseln des Behälters ohne abnehmen des Deckels (kein Kondenswasser-Rücklaufsystem)
 polished, rolltop cover adjustable at 90° and 180°, foodpan 65 mm deep + waterpan + 2 burner holders, change of the container without removing the lid (condensed water can not be led back into the waterpan)
 pulido brillante, tapa rolltop a 90° o 180°, cubeta de 65 mm+ 2 quemadores, cuba baño maría. Se puede cambiar la cubeta sin retirar la tapa. Importante: el agua condensada no revierte en los alimentos
 poli brillant, couvercle rolltop ouverture de 90° a 180°, bac de 65 mm, bain-marie, 2 brûleurs. Le bac peut être retiré et remplacé sans démonter le couvercle. Important: la condensation ne retombe pas sur les aliments.

	cm	↑ cm	ltr.	
12320	64 x 46	44	9	GN 1/1
12321	Ø 48	46	6	

Elektro-Heizelement / heating unit / resistencia / résistance

12290	360 W / 140 - 250 V
12292	600 W / 230 V
12294	800 W / 230 V

Wasserbecken inkl. Vorrichtung für Heizelement / waterpan / baño maría / bain-marie

12249



wechseln des GN-Behälters ohne Abnehmen des Deckels
(kein Kondenswasser-Rücklaufsystem)



Chafing Dish „CATERER PRO“



Deckel hochglanzpoliert, Deckelgriffe hitzebeständig + 2 Brennpastenbehälter + Wasserbecken, inkl. Vorrichtung für Heizplatte + Gestell mit Deckelhalterung (ohne GN Speisenbehälter)
 cover mirror polished finish, cover knob heat-resistant + 2 burner holders + waterpan with screws for heating unit + frame with coverholder (without GN foodpan)
 tapa pulido brillante, asas frías + 2 quemadores + cuba inferior con tornillos para resistencia removible (no incluida) + tapa y estructura con sujeción de la tapa (se sirve sin la cubeta GN)
 couvercle poli brillant, anses froides + 2 brûleurs + bac bain-marie avec fixations pour résistance amovible (non incluse)

	cm	↑ cm
12233	64 x 35	34

Ersatzdeckel / replacement cover / tapa de recambio / couvercle de rechange

12236

Wasserbecken inkl. Vorrichtung für Heizelement / waterpan / baño maría / bain-marie

12249



Chafing Dish „CATERER“



Speisenbehälter GN 1/1 65 mm tief + 2 Brennpastenbehälter + Wasserbecken inkl. Vorrichtung für Heizelement + Deckel + Gestell mit Deckelhalterung (Lieferung ohne Heizelement)
 foodpan GN 1/1 65 mm deep + 2 burner holders + 1 waterpan with screws for heating unit + cover + frame with coverholder (without heating unit)

1 cubeta GN 1/1 - 65 mm + 2 quemadores + cuba baño maría con fijaciones para resistencia amovible + estructura con bloqueo tapa (se sirve sin la resistencia)

1 bac GN 1/1 - 65 mm + 2 brûleurs + 1 bac bain-marie avec 4 vis pour fixation d'une résistance de chauffe amovible (non incluse) + couvercle + chassis avec blocage couvercle

	cm	↑ cm	ltr.
12240	67 x 35	35	9

Ersatzdeckel / replacement cover / tapa de recambio / couvercle de rechange

12260

Wasserbecken inkl. Vorrichtung für Heizelement / waterpan / baño maría / bain-marie

12249



Rolltop-Chafing Dish „CATERER“



Speisenbehälter GN 1/1 65 mm tief + Rolltop-Deckel 90° + Wasserbecken inkl. Vorrichtung für Heizplatte + 2 Brennpastenbehälter (Lieferung ohne Heizplatte), massiver Ständer
 foodpan GN 1/1 65 mm deep + rolltop cover 90° + waterpan with screws for heating unit + 2 burner holders (without heating unit), stable frame

1 cubeta GN 1/1 - 65 mm + campana rolltop abatible a 90° + 2 quemadores + cuba baño maría con fijaciones para resistencia amovible (se sirve sin la resistencia)

1 bac GN 1/1 - 65 mm + couvercle rolltop ouverture 90° + 2 brûleurs + 1 bac bain-marie avec 4 vis pour fixation résistance de chauffe amovible (non incluse)

	cm	↑ cm	ltr.
12245	67 x 35	45	9

Wasserbecken inkl. Vorrichtung für Heizelement / waterpan / baño maría / bain-marie

12249

inkl. Vorrichtung für Heizelement
 incl. screws
 for heating unit



hot price

Chafing Dish „CHEF“



Speisenbehälter GN 1/1 65 mm tief + 2 Brennpastenbehälter + Wasserbecken + Deckel + Gestell mit Deckelhalterung + langer Hohlgriff
 foodpan GN 1/1 65 mm + 2 burner holders + waterpan + cove + frame with coverholder

1 cubeta GN 1/1 65 mm + 2 quemadores + cubeta para el agua + tapa y chasis con bloqueo para la tapa

1 bac GN 1/1 - 65 mm + 2 brûleurs + 1 bac bain-marie + couvercle + chassis avec blocage couvercle + poignée tube creux

	cm	↑ cm	ltr.
11675	61 x 31	30	9

Chafing Dish, GN Container & Transport



Chafing Dish Set „CHEF PLUS“



Speisenbehälter GN 1/1 65 mm tief + 2 Behälter GN 1/2 65 mm tief + 2 Brennpastenbehälter + Wasserbecken + Deckel + Gestell mit Deckelhalterung
 foodpan GN 1/1 65 mm deep + 2 foodpans GN 1/2 65 mm deep + 2 burner holders + waterpan + cover + frame with coverholder
 1 cubeta GN 1/1 - 65 mm + 2 cubetas GN 1/2 - 65 mm + 2 quemadores + 1 cuba baño maría + tapa y marco para sujetar la tapa
 1 bac GN 1/1 - 65 mm + 2 bacs GN 1/2 - 65 mm + 2 brûleurs + 1 bac bain-marie + couvercle, chassis avec blocage couvercle

	cm	↑ cm	ltr.
11686	61 x 31	30	9



Chafing Dish „ECONOMIC“



Speisenbehälter GN 1/1 65mm tief + 2 Brennpastenbehälter + Wasserbecken + Deckel, Gestell mit Deckelhalterung
 foodpan GN 1/1 65 mm + 2 burner holders + waterpan + cover, frame with coverholder
 cubeta GN 1/1 65 mm + 2 quemadores+ cubeta para el agua + bloqueo para la tapa
 bac GN 1/1 65 mm + 2 brûleurs + bac bain-marie + couvercle + chassis avec blocage couvercle

	cm	↑ cm	ltr.
11680	61 x 36	30	9
11680	61 x 36	30	9 > 20 Stk. / pcs.

11618 61 x 36 30 ohne Speisenbehälter / without foodpan
 sin la cubeta / sans le bac GN



Chafing Dish „BUFFET“



2 Speisenbehälter GN 1/2 65 mm tief + 2 Brennpastenbehälter + Wasserbecken + Deckel, Gestell mit Deckelhalterung
 2 foodpans GN 1/2 65 mm deep + 2 burner holders + waterpan + cover, frame with coverholder
 2 cubetas GN 1/2 - 65 mm + 2 quemadores+ cubeta para el agua + tapa y bloqueo para la tapa
 2 bacs GN 1/2 - 65 mm + 2 brûleurs + 1 bac bain-marie + couvercle + chassis avec blocage couvercle

	cm	↑ cm	ltr.
11685	61 x 36	30	2 x 3,5



Chafing Dish „TWIN“, 2er Set



komplette Sets, inkl. GN 1/1 Speisenbehälter 65 mm tief
 complete sets, incl. GN 1/1 foodpan 65 mm deep
 2 chafing dish completos con cubetas GN 1/1
 2 chafing dish complets avec bacs GN 1/1

	cm	↑ cm	ltr.
11699	61 x 36	30	9 2 pcs.



Chafing Dish „CHEF“



Speisenbehälter + Wasserbecken + 1 Brennpastenbehälter + Deckel + Gestell
 foodpan + waterpan + 1 burner holder + cover + frame
 cubeta redonda + baño maría + 1 quemador + tapa + soporte
 récipient + bain-marie + 1 brûleur + couvercle + support

	Ø cm	↑ cm	ltr.
11692	34	34	7,5

Speisebehälter / foodpan / cubeta / bac supérieur

11658



Chafing Dish „ECONOMIC“



Speisenbehälter + Wasserbecken + 1 Brennpastenbehälter + Deckel + Gestell
 foodpan + waterpan + 1 burner holder + cover + frame
 cubeta redonda + baño maría + 1 quemador + tapa + soporte
 récipient + bain-marie + 1 brûleur + couvercle + support

	Ø cm	↑ cm	ltr.
11695	34	26	3,5

Speisebehälter / foodpan / cubeta / bac supérieur

11657



Suppentopf „HOT POT“

hot pot / soup pot
 olla para buffet
 marmite de buffet



Speisenbehälter + Wasserbecken + 1 Brennpastenbehälter + Deckel + Gestell
 foodpan + waterpan + 1 burner holder + cover + frame
 cubeta + baño maría + 1 quemador + tapa + soporte
 récipient + bain-marie + 1 brûleur + couvercle + support

	Ø cm	↑ cm	ltr.
11696	30	36	11,0
11678	33	35	13,5



GN 1/1 100 mm
14 ltr.

Elektro-Rolltop-Chafing Dish „ELITE“

electric rolltop chafing dish
chafing dish eléctrico rolltop
chafing dish électrique rolltop



poliert, Rolltop-Deckel klappbar auf 90° und 180°, Elektro-Wasserbecken mit Temperaturregelung + Speisenbehälter GN 1/1 100 mm tief, 220 - 240 V ~ 50 Hz; 760 - 900 W (kein Kondenswasser-Rücklaufsystem)

polished, rolltop cover adjustable at 90° and 180°, electric waterpan with adjustable heatcontrol + foodpan GN 1/1 100 mm deep, voltage 220 - 240 V ~ 50 Hz, power consumption 760 - 900 W (condensed water cannot be led back into the waterpan)

pulido brillante, tapa abatible apertura a 90° o 180°, baño maría c/ termostato + cubeta GN 1/1 - 100 mm, 220-240 V-50 Hz. Consumo 760-900 W (el agua condensada no gotea dentro de la cubeta)
poli brillant, couvercle rolltop ouverture à 90° ou 180°, bain-marie électrique avec thermostat + bac GN 1/1-100 mm, 220-240 V - 50 Hz; 760-900 W (Important: la condensation ne retombe pas sur les aliments)

	cm	↑ cm	ltr.
12360	67 x 47	45	14



Elektro-Rolltop-Chafing Dish „ELITE“

electric rolltop chafing dish
chafing dish eléctrico rolltop
chafing dish électrique rolltop



poliert, Rolltop-Deckel klappbar auf 90° und 180°, Elektro-Wasserbecken mit Temperaturregelung + Speisenbehälter, 220 - 240 V ~ 50 Hz; 420 - 500 W (kein Kondenswasser-Rücklaufsystem)

polished, rolltop cover adjustable at 90° and 180°, electric waterpan with adjustable heatcontrol + foodpan, voltage 220 - 240 V ~ 50 Hz, power consumption 420 - 500 W (condensed water cannot be led back into the waterpan)

pulido brillante, tapa abatible apertura a 90° o 180°, baño maría c/ termostato - 220-240 V-50 Hz. 420-500 W (el agua condensada no gotea dentro de la cubeta)

poli brillant, couvercle rolltop ouverture à 90° ou 180°, bain-marie électrique avec thermostat, 220-240 V - 50 Hz; 420-500 W (Important: la condensation ne retombe pas sur les aliments)

	Ø cm	↑ cm	ltr.
12356	45	45	6,8

Speisenbehälter / foodpan / cubeta superior / bac supérieur

12357



Rolltop-Chafing Dish „ELITE“



poliert, Rolltop-Deckel klappbar auf 90° und 180° + Speisenbehälter + Wasserbehälter inkl. Vorrichtung für Heizplatte + 1 Brennpastenbehälter, Hohlgriff kann nicht heiß werden, wechseln des Behälters ohne abnehmen des Deckels (kein Kondenswasser-Rücklaufsystem)

polished, rolltop cover adjustable at 90° and 180° + foodpan + 1 burner holder, waterpan with screws for heating unit (not included), change of the container without removing the lid (condensed water can not be led back into the waterpan)

pulido brillante, tapa rolltop a 90° o 180°, cubeta + 1 quemadores, cuba baño maría con fijaciones para resistencia (se sirve sin la resistencia), se puede cambiar la cubeta GN sin retirar la tapa, importante: el agua condensada no revierte en los alimentos

poli brillant, couvercle rolltop ouverture de 90° a 180°, bac, bain-marie avec 4 vis pour fixation résistance de chauffe amovible (non incluse), 2 brûleurs, le bac GN peut être retiré et remplacé sans démonter le couvercle, important: la condensation ne retombe pas sur les aliments

	Ø cm	↑ cm	ltr.
12355	45	45	5



Elektro-Chafing Dish „INOXSTAR“

electric chafing dish
chafing dish eléctrico
chafing dish électrique



poliert, Thermostat-Regelung, Speisenbehälter GN 1/1 100 mm tief, Deckelhalter, 900 W, 230 V

polished, thermostat control, foodpan GN 1/1 100 mm deep, lid holder, 900 W, 230 V
pulido brillante, termostato de control, cubeta GN 1/1-100 mm, bloqueo para la tapa, 900 W, 230 V
poli brillant, thermostat, bac GN 1/1-100 mm, blocage du couvercle, 900 W, 230 V

	cm	↑ cm	ltr.
12222	62 x 35	29	13,5

Deckel / cover / tapa / couvercle

12235



Elektro Chafing Dish

electric chafing dish
chafing dish eléctrico
chafing dish électrique



Speisenbehälter GN 1/1 100 mm tief, Deckelhalter, Thermostat-Regelung 900 W, 230 V

foodpan GN 1/1 100 mm deep, lid holder, thermostat control 900 W, 230 V
cubeta GN 1/1-100 mm, sujeción de la tapa, termostato, 900W, 230 V
bac GN 1/1-100 mm, blocage du couvercle, thermostat, 900W, 230 V

	cm	↑ cm	ltr.
12225	63 x 36	29	14

Deckel / cover / tapa / couvercle

12235



Elektro-Chafing Dish „ECO“

electric chafing dish
chafing dish eléctrico
chafing dish électrique



Deckel poliert, Elektro-Wasserbecken mit Temperaturregelung + Speisenbehälter GN 1/1 65 mm tief, 220 - 240 V ~ 50 Hz; 760 - 900 W

cover polished, electric waterpan with adjustable heatcontrol + foodpan GN 1/1 65 mm deep, voltage 220 - 240 V ~ 50 Hz, power consumption 760 - 900 W

tapa pulido brillante, baño maría c/ termostato + cubeta GN 1/1 - 65 mm - 220-240 V-50 Hz. / 760-900 W

couvercle poli brillant, bain-marie électrique avec thermostat + bac GN 1/1-65 mm, 220-240 V - 50 Hz; 760-900 W

	cm	↑ cm	ltr.
12232	63 x 36	29	9



Elektro-Chafing Dish „ECO“

electric chafing dish
chafing dish eléctrico
chafing dish électrique



Glasdeckel (Rand poliert), Elektro-Wasserbecken mit Temperaturregelung + Speisenbehälter, 220 - 240 V ~ 50 Hz; 420 - 500 W

cover polished, electric waterpan with adjustable heatcontrol + foodpan, voltage 220 - 240 V ~ 50 Hz, power consumption 420 - 500 W

tapa vidrio borde pulido brillante, baño maría c/ termostato - 220-240 V-50 Hz. 420-500 W

couvercle verre bord poli brillant, bain-marie électrique avec thermostat, 220-240 V - 50 Hz; 420-500 W

	Ø cm	↑ cm	ltr.
12221	36	25	6,8

NEW



ohne Wasserbad
without water bath

Elektrischer Suppentopf

electric soup warmer
marmita de sopa eléctrica
marmite à soupe électrique



direkte Wärmeübertragung ohne Wasserbad, manuelle Temperaturregelung mit digitalem Anzeigenfenster, Temperatur einstellbar zwischen 60 ° C und 80 ° C, 1000 W / 230 V, herausnehmbarer Einsatz aus Edelstahl, Deckel mit hitzeisoliertem Griff und Löffelaussparung
direct heat transfer without bain marie, manual temperature control with digital display window, temperature adjustable between 60 ° C and 80 ° C, 1000 W / 230 V, removable stainless steel insert, lid with heat insulated handle and notched for spoon
traspaso térmico directo sin baño maría, control manual de la temperatura con ventana de visualización digital, temperatura ajustable entre 60 ° C y 80 ° C, 1000 W / 230 V, inserto de acero inoxidable extraíble, tapa con asas frías y con hueco para la cuchara
transfert direct de chaleur sans bain-marie, contrôle manuel de la température avec fenêtre d'affichage numérique, température réglable entre 60 ° C et 80 ° C, 1000 W / 230 V, insert en acier inoxydable amovible, couvercle avec poignée d'isolation thermique et avec espace pour la louche

	Ø cm	↑ cm	litr.
11903	34,0	33,0	10



hot price



Elektrischer Suppentopf „ECONOMIC“

electric soup warmer
marmita de sopa eléctrica
marmite à soupe électrique



Stahl schwarz lackiert, herausnehmbarer Einsatz aus Edelstahl, Temperaturregelung 30°C - 90°C, dreh- und klappbarer Edelstahl-Deckel, inkl. 8 magnetisch haftenden Beschriftungen, 400 W / 230 V
metal, black, removable soup pot, thermostat 30°C - 90°C, st. steel lid, incl. 8 magnetic signs, 400 W / 230 V
metal negro, recipiente sopa inox extraíble, termostato 30°C- 90°C, tapa inox, incluye 8 let- reros magnéticos, 400 W / 230 V
acier, noir, récipient à soupe inox amovible, thermostat 30°C - 90°C, couvercle inox, 8 étiquet- tes magnétiques, 400 W / 230 V

	Ø cm	↑ cm	litr.
11915	32	36	9

Speisenbehälter / foodpan / recipiente sopa / récipient à soupe

11916

Deckel / cover / tapa / couvercle

11917



Elektrischer Suppentopf

electric soup warmer
marmita de sopa eléctrica
marmite à soupe électrique



herausnehmbarer Einsatz aus Edelstahl, elektrisch, mit Wasserbad + Löffel + integrierter Tragering für den Innenbehälter, Deckel mit hitzeisolierendem Griff, Temperaturregelung 80°C (± 10°C), 450-550 W, 230 V

removable soup st. steel pan, bain marie electric, ladle, circular frame, thermostat control till 80°C (± 10°C), 450-550 W, 230 V

recipiente sopa inox extraíble, baño maria eléctrico + cucharón + aro inox, tapa con asas frías, termostato hasta 80°C precisión (± 10°C), 450-550 W, 230 V

réceptif à soupe inox amovible, bain-marie électrique, louche, support circulaire inox, thermostat maxi 80°C (± 10°C), 450-550 W, 230 V

	Ø cm	↑ cm	ltr.	Farbe / Colour
11901	38	36,5	10	■
11902	38	36,5	10	■



Elektrischer Suppentopf

electric soup warmer
marmita de sopa eléctrica
marmite à soupe électrique



herausnehmbarer Einsatz aus Edelstahl, elektrisch, mit Wasserbad + Löffel + integrierter Tragering für den Innenbehälter, Deckel mit hitzeisolierendem Griff, Temperaturregelung 80°C (± 10°C), 400 - 450 W / 220 - 240 V

removable soup st. steel pan, bain marie electric, ladle, st. steel circular frame, thermostat control till 80°C (± 10°C), 400 - 450 W / 220 - 240 V

recipiente sopa inox extraíble, baño maria eléctrico + cucharón + aro inox, tapa con asas frías, termostato hasta 80°C precisión (± 10°C), 400 - 450 W / 220 - 240 V

réceptif à soupe inox amovible, bain-marie électrique, louche, support circulaire inox, thermostat maxi 80°C (± 10°C), 400 - 450 W / 220 - 240 V

	Ø cm	↑ cm	ltr.
11910	40	37	10

Edelstahlgefäß / stainless steel pan / recipiente sopa inox / réceptif à soupe inox

11911

Edelstahl-Deckel / stainless steel lid / tapa inox / couvercle inox

11912

Elektrokabel / electric cable / cable eléctrico / cable électrique

11913



Elektro-Suppenstation

soup warmer
chafing dish doble para sopa
chafing dish 2 soupieres



2 Suppentöpfe + 2 Suppenkellen + Deckelhalter, Thermostat (Überhitzungsschutz), 900 W, 230 V
2 soup pots + 2 soup ladles + lid holder, thermostat control 900 W, 230 V
incluye 2 ollas de sopa + 2 cucharones + bloqueo de la tapa, termostato 900 W, 230 V
2 marmites + 2 louches + blocage du couvercle + thermostat, 900 W, 230 V

	cm	↑ cm	ltr.
12228	65 x 35,5	31	2 x 4



Rolltophaube „SWISS“

rolltop-cover
campana rolltop
cloche rolltop



hochglanzpoliert, klappbar auf 90°, nachrüstbar für alle handelsüblichen Chafer
mirror polished finish, cover adjustable at 90°, usable for all commercial chafing dishes
pulido brillante, tapa ajustable 90°, apto para todos los chafings profesionales
poli brillant, ouverture réglable à 90°, apte pour tous les chafings professionnels

	cm	↑ cm
12310	55 x 34	19,5



Bain-Marie Topf

bain marie pot
olla baño Maria
marmite bain-marie



inkl. Deckel, mit Löffelaussparung
included cover, notched for spoon
incluye tapa con hueco para la cuchara
includ le couvercle avec espace pour la louche

	Ø cm	↑ cm	ltr.
12244	20	18	4,5

Deckel / cover / tapa / couvercle

11244



Bain-Marie Deckel

cover for bain marie
tapa del baño maría
couvercle du bain-marie



	cm
12243	54 x 33,5



12 ltr.

Kaffeedispenser „ROYAL“

coffee dispenser
dispensador de café
distributeur de café



hochglanzpoliert, für warme Getränke, stabil und standfest, inkl. 1 Brennpastenbehälter
mirror polished finish, for warm drinks, solid and stable, incl. 1 burner holder
acabado brillante para bebidas calientes, sólido y estable, incluye un calentador
brillant, pour boissons chaudes, avec 1 brûleur, robuste et stable

	cm	↑ cm	ltr.
11667	28 x 28	65	12



10,5 ltr.

Kaffeedispenser „HAPPY HOUR“

coffee dispenser
dispensador de café
distributeur de café



hochglanzpoliert, für warme Getränke, stabil und standfest, inkl. 1 Brennpastenbehälter
mirror polished finish, for warm drinks, solid and stable, incl. 1 burner holder
acabado pulido brillante para bebidas calientes, sólido y estable, incluye un calentador
brillant, pour boissons chaudes, avec 1 brûleur, robuste et stable

	cm	↑ cm	ltr.
11672	31 x 33,5	54,5	10,5

Hahn / tap / grifo / robinet

11671

Elektro-Heizelement / heating unit / resistencia / résistance

	cm	↑ cm
12287	21 x 20	6



Hot Plate „ECONOMIC“

hot plate
placa caliente
plaque chaude



automatische Temperaturregelung, die Alu-Heizplatte ist in ca. 5 Minuten auf ca. 75°C erhitzt und hält Speisen auf konstanter Temperatur, CE-Zeichen
with automatic power supply, gets up to 75°C in 5 min., keeps food on continuous temperature control automático de temperatura, mantiene los alimentos en temperatura constante, la placa de aluminio llega a 75° C en aprox. 5 min.
contrôle automatique de température, maintient les aliments à température constante sur la plaque aluminium, monté à 75°C en 5 min. approx.

	cm	GN
11920	53 x 32,5	1/1



Einbau-Induktionskochplatte für Chafing Dish

built-in induction plate for chafing dish
placa de inducción para empotrar
plaque à induction à encastrer

inkl. Kabel-Fernbedienung, energiesparend, Leistung in 5 Stufen regelbar, integrierte Lüftung, sehr leise im Betrieb
incl. cable remote control, energy-saving, power adjustable in 5 steps, integrated ventilation, very quiet in operation
incl. mando a distancia con cable, ahorro energético, potencia regulable en 5 pasos, ventilación integrada, funcionamiento silencioso
y compris télécommande filaire, économie en énergie, puissance réglable en 5 étapes, ventilation intégrée, très silencieux en fonctionnement

	cm	↑ cm	
12285	35,5 x 35,5	6	2000 W



Induktionskochplatte für Chafing Dish

induction plate for chafing dish
placa de inducción para chafing dish
plaque à induction pour chafing dish

mit Regler
with power control
con control de potencia
avec régulateur

	Ø cm	
12295	24	900 W



Metallrahmen für Induktionskochplatten

frame for induction plate
marco para placa de inducción
cadre support inox pour plaque induction



12291	für runde Chafer / for round chafing dish
12296	für Chafer GN 1/1 / for GN 1/1 chafing dish



Elektro-Heizelement

heating unit
resistencia
résistance



für **mehrheitlich geöffnete** Chafer GN 1/1 mit **einstellbarem Leistungsregler**
for GN 1/1 chafer covers are open most of the time, with adjustable control
para GN 1/1 chafing dish abiertos, con termostato
pour chafing dish GN 1/1 dont le couvercle reste souvent ouvert, avec thermostat

12294 800 W / 230 V



Elektro-Heizelement

heating unit
resistencia
résistance



für **mehrheitlich geöffnetem** Chafing Dish GN 1/1
for GN 1/1 chafer covers open most of the time
para chafing dish GN 1/1 con la tapa casi siempre abierta
pur chafing dish GN 1/1 dont le couvercle reste souvent ouvert

12292 600 W / 230 V



Elektro-Heizelement

heating unit
resistencia
résistance



für **mehrheitlich geschlossene** Chafer GN 1/1
for GN 1/1 chafer covers are closed most of the time
para chafing dish GN 1/1 casi siempre cerrados
pour chafing dish GN 1/1 qui restent habituellement fermés

12290 360 W / 140 - 250 V



Elektro-Heizelement

heating unit
resistencia
résistance



für **Kaffeedispenser** (Nr. 11672), 500 W, 220 V, einfach in das Gestell des Dispensers legen
for coffee dispenser (no. 11672), 500 W, 220 V, insert into the frame of the dispenser
para dispensador de café (11672), 500 W, 220V, directamente en el pie del dispensador
pour distributeur à café (11672), 500 W, 220 V, directement dans le support

12287 500 W / 220 V



Mobile Chafing Dish Heizung

heating element
resistencia
résistance



für **alle marktgängigen** Chafing Dishes
suitable for all current popular chafing dishes, with special spring
para todos los chafing dish más corrientes
pour la plupart des chafing dish les plus courants

12299	Ø cm	↑ cm	500 W / 220 V
	14	9 - 11	



Heizplatte durch Spiralfeder an Wasserbad gedrückt
Heizplatte durch Spiralfeder an Wasserbad gedrückt



Chafing Dish „VEGGIE“



Speisenbehälter + Wasserbecken + 1 Brennpastenbehälter + Deckel + Gestell
 foodpan + waterpan + 1 burner holder + cover + frame
 cubeta redonda + baño maría + quemador + tapa + soporte
 récipient + bain marie + brûleur + couvercle + support

	Ø cm	↑ cm	ltr.
11693	35	28	4



praktischer Halter für den Deckel
 included cover holder



Servierschale „FEUERZANGENBOWLE“



warmer
 calentador para quemada
 chauffe-plat spécial sucre flambé

Stövchen verchromt, Edelstahl-Deckel hochglanzpoliert, Kelle und Zuckerhutablage aus Edelstahl

frame chrome plated, stainless cover mirror polished finish, incl. ladle and sugar holder especial para preparar bebidas calientes, con azúcar o quemadas, redondo, pie cromado, incluye cucharón y soporte para el bloque de azúcar.

spécial pour la préparation de boissons chaudes, pied chromé, inclut la louche et le support à sucre

	Ø cm	↑ cm	ltr.
65065	23	26	4

Feuerzange / fire tong / soporte para quemada / support pour sucre à flamber

	cm
65066	31 x 7



Servierschale mit Stövchen „HOT POT“



warmer
 caliente platos
 chauffe-plat

Stövchen verchromt, Edelstahl-Deckel hochglanzpoliert, inkl. Schöpfkelle

frame chrome plated, stainless cover mirror polished finish, incl. ladle cacerola de vidrio termoresistente, soporte cromado, tapa con pulido brillante, apto para horno

bol en verre thermo-résistant, pied chromé, couvercle brillant, apte pour cuisson au four

	Ø cm	↑ cm	ltr.
65035	23	26	4

Ersatz-Glaseinsatz / spare glass / fuente de recambio vidrio / plat de rechange en verre

64201



Servierschale mit Stövchen

warmer
calienta platos
chauffe-plat



feuerfeste Glasschale, Stövchen verchromt, Deckel hochglanzpoliert, Backofen geeignet
glas bowl fireproof, frame chrome plated, cover mirror polished finish, suitable for oven
fuente de vidrio termoresistente, soporte cromado, tapa con pulido brillante, apto para horno
plat en verre thermo-résistant, pied chromé, couvercle brillant, apte pour cuisson au four

	cm	↑ cm	ltr.
65010	47 x 24	13	3
65020	44 x 25	13	3
65030	45 x 29	12	2 x 1,5

Ersatz-Glaseinsatz / spare glass / fuente de recambio vidrio / plat de rechange en verre

	fits to
64001	65010
64051	65020
64151	65030



Servierschale mit Stövchen

warmer
calienta platos
chauffe-plat



feuerfeste Glasschale, Stövchen verchromt, Deckel hochglanzpoliert, Backofen geeignet
glas bowl fireproof, frame chrome plated, cover mirror polished finish, suitable for oven
fuente de vidrio termoresistente, soporte cromado, tapa con pulido brillante, apto para horno
plat en verre thermo-résistant, pied chromé, couvercle brillant, apte pour cuisson au four

	cm	↑ cm	ltr.
65033	Ø 26	22	2
65034	29,5 x 18	12	1,5



Butter- und Saucenwärmer

butter and sauce pan warmer
calentador de mantequilla y salsa
réchaud à beurre et sauce



Saucentopf mit Ausgießer + Deckel + Gestell (passend für 1 Teelicht)
pan with spout + lid + riser (for 1 light)
cacerola + tapadera + soporte (para 1 vela)
petite casserole avec bec verseur + couvercle + support (pour 1 bougie)

	Ø cm	↑ cm	ltr.	
35350	14	16	0,7	Griff: 13,5 cm / handle: 13,5 cm asa: 13,5 cm / poignée: 13,5 cm



praktischer Ausgießer
included lid



Speisenwärmer „PROFI“

plate warmer
calienta platos
chauffe-plat



Rahmen aus Edelstahl mit Aluminium-Wärmeplatte

stainless steel frame, thick aluminium plate
soporte inox con placa de aluminio
support inox avec plaque aluminium

	cm	↑ cm	
35050	33 x 18	7	2 Teelichter / 2 tealights 2 velas / 2 bougies
35070	45 x 18	7	3 Teelichter / 3 tealights 3 velas / 3 bougies



Speisenwärmer

warmer
calienta platos
chauffe-plat



3-flammig

3 lights
3 velas
3 bougies

	cm	↑ cm	
35065	34 x 18	6	



Speisenwärmer

warmer
calienta platos
chauffe-plat



2-flammig, matt poliert

2 lights, satin polished finish
2 velas, acero inoxidable acabado mate
2 bougies, inox finition mate

	cm	↑ cm	
35343	34 x 13	6	



Brennpastenbehälter

burner holder
quemador
brûleur



mit Bajonettverschluss
bayonet lock
cierre de bayoneta
verrouillage par baïonnette

	Ø cm	↑ cm
11683	9	6



Sicherheitsbrenner „HOT & SAFE“

refillable burner
quemador recargable
brûleur rechargeable



speziell für den Einsatz von „HOT & SAFE“ Brennflüssigkeit (Pat. Nr. 00108134), für jeden Chafing-Dish geeignet, verbrennt zu 100%, besonders sparsam, minimale Geruchsentwicklung, Brennflüssigkeit kann nicht auslaufen, Brenndauer pro Füllung à 200 ml: 2 bis 2,5 h. A special splash guard prevents any unintentional fuel leakage. An adapter ring allows you to use the burner in any type of chafing dish equipment. Since the new fuel burns cleanly, no soot or smoke is produced. Since more intense heat is generated than with conventional fuel paste, your foods remain hot longer, the fuel is easy to measure, non-toxic. à 200 ml: 2 to 2,5 h. Muy seguro y sano: borde anti-salpicadura, aro adaptador para cualquier tipo de chafing dish. El combustible se quema de forma limpia, sin humo ni residuos. Ahorro: El calor desprendido es más intenso que con otros combustibles convencionales, manteniendo los platos calientes más tiempo. Fácil de rellenar, no tóxico. 200 ml duran de 2 a 2,5 horas. Chaleur saine en toute sécurité. Bord anti-éclaboussures. Anneau adaptateur pour tous les types de chafing dish. Le combustible brûle sans émettre ni fumée ni suie. Economique: La chaleur est plus intense qu'avec les autres combustibles conventionnels et maintient donc les plats chauds plus longtemps. Facile à recharger. 200 ml durent de 2 à 2,5 heures.

	Ø cm	↑ cm
00100	9	6



Flasche Brennflüssigkeit „HOT & SAFE“

bottle fuel
botella de combustible líquido
bouteille de combustible liquide



	ltr.	fits to
00208	1	00100



Wärme-Kies

granite chips
granulado térmico
gravier thermique



für Chafing Dishes, feine Körnung, hohe Wärmespeicherung, kein Verkleben, ideal zum Warmhalten von Eiern
fine for chafing dishes and clean granite chippings, ideal for keeping eggs warm
gravilla de granito fina limpia, ideal para mantener los huevos calientes
gravier fin de granit, lavé, idéal pour maintenir les oeufs au chaud

	kg
81116	7



Chafing Dish, GN Container & Transport

GN-Behälter Größen nach EN 631

Alle Behälter sind aus rostfreiem Chrom-Nickel-Edelstahl mit elektrolytisch polierter (seidenmatt) Oberfläche und somit perfekt geeignet für den professionellen Einsatz.

GN-container according to EN 631

All pans are made of chrome/nickel stainless steel with a surface polished by electrolysis (satin-matt) and therefore highly suitable for professional operation.

De conformidad con la norma europea EN 631.

Todos los contenedores están fabricados en acero inoxidable cromado/niquelado con su superficie (satinada) pulida por electrolisis lo que la hace altamente apropiado para el uso profesional.

Bacs GN- Conforme à la norme EN 631

Tous les bacs sont fabriqués en inox/chrome/nickel, surface polie électrolythique (satiné). Approprié pour usage professionnel.

Vorteile der rundgeprägten U-Ecken:

- erhöhte Stabilität durch verstärktes Profil
- zielgerechtes und sauberes Ausgießen
- genaue Positionierung der GN-Behälter
- superleichtes Stapeln und Entstapeln
- kein Verklemmen der GN-Behälter
- hohe Stoßfestigkeit durch robuste Konstruktion
- ansprechendes Design und stilvoller Blickfang

Advantages of the round-shaped U-Corners:

- increased stability due to the unique construction
- clean ladling and pouring
- exact positioning of the containers
- improved shock-resistance
- appealing design
- no seize of the containers

Ventajas de las esquinas en U:

Perfil reforzado que confiere mayor rigidez y resistencia a la cubeta, diseño para verter fácil y limpiamente, fáciles de apilar y desapilar sin que se claven entre sí, construcción más robusta y resistente a los golpes mecánicos, diseño elegante.

Avantages et fonctionnalité des angles en U:

Profil renforcé pour une meilleure consistance et rigidité du récipient, design qui facilite un versage propre et aisé, permet un empilage et désempliage faciles sans que les bacs restent coincés, meilleure résistance aux chocs mécaniques, seign élégant.

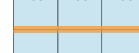
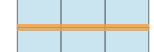
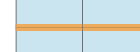
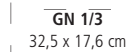
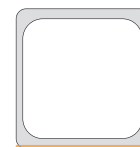
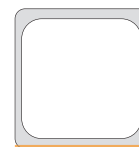
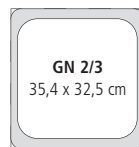
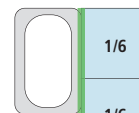
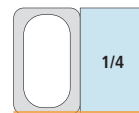
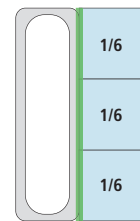
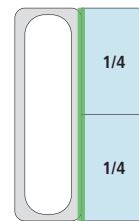
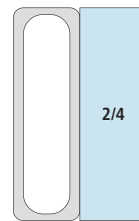
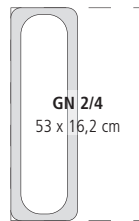
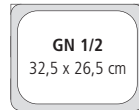
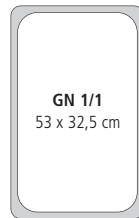



GN-Behälter

GN-container

GN cubetas

GN bacs



	GN	↓ mm	ltr.	cm
81000	2/1	20	5,0	53,0 x 65,0
81095	1/1	10	1,25	53,0 x 32,5
81100	1/1	20	2,5	53,0 x 32,5
81101	1/1	40	5,0	53,0 x 32,5
81109	1/1	55	6,5	53,0 x 32,5
81102	1/1	65	9,0	53,0 x 32,5
81104	1/1	100	13,25	53,0 x 32,5
81106	1/1	150	20,0	53,0 x 32,5
81108	1/1	200	28,0	53,0 x 32,5
81200	1/2	20	1,0	32,5 x 26,5
81201	1/2	40	2,0	32,5 x 26,5
81209	1/2	55	2,8	32,5 x 26,5
81202	1/2	65	4,0	32,5 x 26,5
81204	1/2	100	6,0	32,5 x 26,5
81206	1/2	150	8,75	32,5 x 26,5
81208	1/2	200	11,65	32,5 x 26,5
81300	1/3	20	0,75	32,5 x 17,5
81302	1/3	65	2,5	32,5 x 17,6
81304	1/3	100	4,0	32,5 x 17,6
81306	1/3	150	5,7	32,5 x 17,6
81308	1/3	200	7,0	32,5 x 17,6
81400	1/4	20	0,5	26,5 x 16,2
81401	1/4	40	1,0	26,5 x 16,2
81402	1/4	65	1,8	26,5 x 16,2
81404	1/4	100	2,8	26,5 x 16,2
81406	1/4	150	4,0	26,5 x 16,2
81408	1/4	200	5,5	26,5 x 16,2
81602	1/6	65	1,0	17,6 x 16,2
81604	1/6	100	1,6	17,6 x 16,2
81606	1/6	150	2,4	17,6 x 16,2
81608	1/6	200	3,0	17,6 x 16,2
81502	1/9	65	0,6	17,6 x 10,8
81504	1/9	100	1,0	17,6 x 10,8
81506	1/9	150	1,5	17,6 x 10,8
81700	2/3	20	1,5	35,4 x 32,5
81701	2/3	40	3,0	35,4 x 32,5
81702	2/3	65	5,5	35,4 x 32,5
81704	2/3	100	8,4	35,4 x 32,5
81706	2/3	150	12,5	35,4 x 32,5
81707	2/3	200	18,0	35,4 x 32,5
81800	2/4	20	1,2	53,0 x 16,2
81801	2/4	40	2,4	53,0 x 16,2
81802	2/4	65	3,6	53,0 x 16,2
81804	2/4	100	5,6	53,0 x 16,2
81806	2/4	150	8,7	53,0 x 16,2



perforierte GN-Behälter

perforated GN-container
cubetas GN perforadas
bacs GN perforés



	GN	↓ mm	cm
81911	1/1	40	53,0 x 65,0
81907	1/1	65	53,0 x 65,0
81908	1/1	100	53,0 x 65,0
81909	1/1	150	53,0 x 65,0
81910	1/1	200	53,0 x 65,0
81901	1/2	65	32,5 x 26,5
81902	1/2	100	32,5 x 26,5
81903	1/2	150	32,5 x 26,5
81904	1/2	200	32,5 x 26,5
81905	2/3	65	35,4 x 32,5
81906	2/3	100	35,4 x 32,5



GN-Deckel

GN-lid
GN tapa
GN couvercle



ohne Löffelaussparung
without notched edge for spoons
sin agujero para cucharón
sans espace pour louche

	GN	cm
81195	1/1	53,0 x 32,5
81295	1/2	32,5 x 26,5
81395	1/3	32,5 x 17,6
81495	1/4	26,5 x 16,2
81695	1/6	17,6 x 16,2
81591	1/9	17,6 x 10,8
81795	2/3	35,4 x 32,5
81895	2/4	53,0 x 16,2



GN-Deckel

GN-lid
GN tapa
GN couvercle



mit Löffelaussparung
with notched edge for spoons
con agujero para cucharón
avec espace pour louche

	GN	cm
81191	1/1	53,0 x 32,5
81292	1/2	32,5 x 26,5
81391	1/3	32,5 x 17,6
81492	1/4	26,5 x 16,2
81692	1/6	17,6 x 16,2
81595	1/9	17,6 x 10,8
81791	2/3	35,4 x 32,5
81891	2/4	53,0 x 16,2



mit Löffelaussparung
with notched edge for spoons

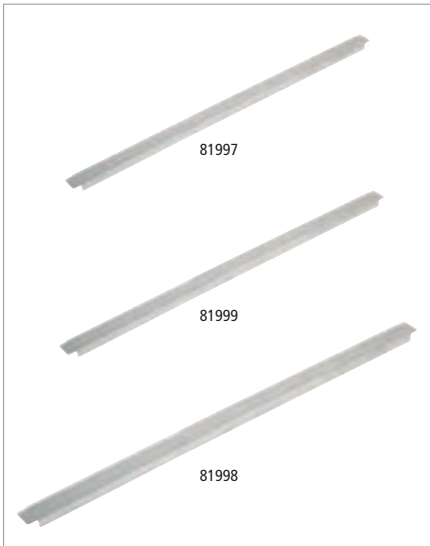

Adapter / Zwischensteg

adapter
adaptador
adaptateur



ermöglicht stabilen Halt von GN-Behältern im CD, rostfreier Chrom-Nickel-Edelstahl
for fixing GN pans, chrome / nickel stainless steel
para sujetar las cubetas GN, acero inox
support stable pour les bacs GN

	cm	
81997	17,6	längs bei GN 1/9 / lengthwise GN 1/9 longitud GN 1/9 / GN 1/9 dans la longueur
81999	32,5	quer bei GN 1/2 / crosswise GN 1/2 de ancho GN 1/2 / GN 1/2 dans la largeur
81998	53	längs bei GN 1/1 / lengthwise GN 1/1 longitud GN 1/1 / GN 1/1 dans la longueur



GN Transport-Steck-Deckel

GN-lid with silicone seal
GN tapa hermética con junta
GN couvercle hermétique avec joint



Silikondichtung, Griffmulde und Loch gegen Unterdruck, nicht für Kombidämpfer geeignet, nicht für ≤ 65 mm tiefe GN-Behälter
silicone joint, flat handle, vent to compensate for pressure, not usable for steam oven, not usable for ≤ 65 mm depth GN-pans
junta de silicona, asa empotrada, válvula para compensar la presión, no se puede utilizar en hornos de vapor, ni para cubetas de altura ≤ 65 mm
joint silicone, anse encastrée, valve pour compenser la pression, ne pas utiliser pour les fours à vapeur ni pour les bacs hauteur ≤ 65 mm

	GN	cm
80023	1/1	53,0 x 32,5
80024	1/2	32,5 x 26,5
80025	1/3	32,5 x 17,6
80026	1/4	26,5 x 16,2
80027	1/6	17,6 x 16,2



GN-Deckel mit Ausschnitt

GN-lid with cut out
GN tapa para GN cubetas
GN couvercle pour GN bacs



	GN	cm
82532	2/3	32,5 x 35,4



GN-Deckel

GN-cover
GN tapa
GN couvercle



	GN	cm
80021	1/1	53,0 x 32,5
80022	1/2	32,5 x 26,5



GN-Behälter aus Polycarbonat

GN-container polycarbonate
GN cubeta policarbonato
GN bac polycarbonate

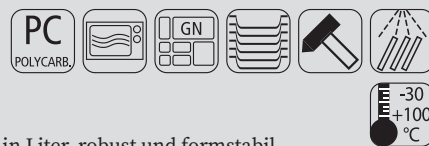

transparent: Inhalt gut erkennbar, Skalierung in Liter, robust und formstabil
transparent: content can be seen, liter scale, solid quality
transparente para ver el contenido, graduación en litros, alta calidad
transparent pour voir le contenu, graduation en litres, haute-qualité

	GN	↓ mm	ltr.	cm
82004	1/1	65	8,5	53,0 x 32,5
82006	1/1	100	13,0	53,0 x 32,5
82008	1/1	150	19,5	53,0 x 32,5
82010	1/1	200	26,0	53,0 x 32,5
	GN	↓ mm	ltr.	cm
82012	1/2	65	3,9	32,5 x 26,5
82014	1/2	100	5,9	32,5 x 26,5
82016	1/2	150	8,9	32,5 x 26,5
82017	1/2	200	11,8	32,5 x 26,5
	GN	↓ mm	ltr.	cm
82018	1/3	65	2,4	32,5 x 17,6
82020	1/3	100	3,6	32,5 x 17,6
82022	1/3	150	5,3	32,5 x 17,6
82023	1/3	200	7,0	32,5 x 17,6
	GN	↓ mm	ltr.	cm
82028	1/4	65	1,7	26,5 x 16,2
82030	1/4	100	2,5	26,5 x 16,2
82032	1/4	150	3,7	26,5 x 16,2
82034	1/4	200	5,5	26,5 x 16,2
	GN	↓ mm	ltr.	cm
82036	1/6	65	1,0	17,6 x 16,2
82038	1/6	100	1,5	17,6 x 16,2
82040	1/6	150	2,2	17,6 x 16,2
82042	1/6	200	3,4	17,6 x 16,2
	GN	↓ mm	ltr.	cm
82050	1/9	65	0,6	17,6 x 10,2
82051	1/9	100	1,0	17,6 x 10,2



GN-Deckel

GN-lid
GN tapa
GN couvercle

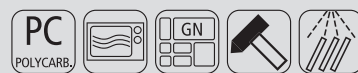

	GN	cm
82001	1/1	53,0 x 32,5
82013	1/2	32,5 x 26,5
82019	1/3	32,5 x 17,6
82029	1/4	26,5 x 16,2
82037	1/6	17,6 x 16,2
82059	1/9	17,6 x 10,8



GN Abtropfgitter

GN drainer
GN escurridor
GN égouttoir



	GN	cm
82003	1/1	53,0 x 32,5
82005	1/2	32,5 x 26,5
82007	1/3	32,5 x 17,6



GN-Behälter aus Polypropylen

GN-container polypropylene
GN cubetas polipropileno
GN bacs polypropilène

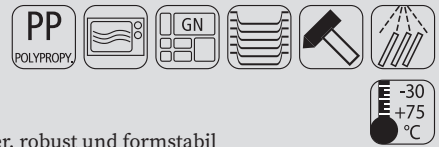

milchig (nicht transparent), Skalierung in Liter, robust und formstabil

frosted, Liter scale, solid quality
translúcido opaco, graduación en litros, muy resistente a la deformación, robusto
translucide opaque, graduation en litres, très résistant à la déformation, robuste

	GN	↓ mm	ltr.	cm
82104	1/1	65	8,5	53,0 x 32,5
82106	1/1	100	13,0	53,0 x 32,5
82108	1/1	150	19,5	53,0 x 32,5
82110	1/1	200	26,0	53,0 x 32,5
82112	1/2	65	3,9	32,5 x 26,5
82114	1/2	100	5,9	32,5 x 26,5
82116	1/2	150	8,9	32,5 x 26,5
82117	1/2	200	11,8	32,5 x 26,5
82118	1/3	65	2,4	32,5 x 17,5
82120	1/3	100	3,6	32,5 x 17,5
82122	1/3	150	5,3	32,5 x 17,6
82123	1/3	200	7,0	32,5 x 17,6
82128	1/4	65	1,7	26,5 x 16,2
82130	1/4	100	2,5	26,5 x 16,2
82132	1/4	150	3,7	26,5 x 16,2
82134	1/4	200	5,5	26,5 x 16,2
82136	1/6	65	1,0	17,6 x 16,2
82138	1/6	100	1,5	17,6 x 16,2
82140	1/6	150	2,2	17,6 x 16,2
82142	1/6	200	3,4	17,6 x 16,2
82150	1/9	65	0,6	17,6 x 10,8
82151	1/9	100	1,0	17,6 x 10,8



stapelbar
stackable



GN-Deckel

GN-lid
GN tapa
GN couvercle



	GN	cm
82101	1/1	53,0 x 32,5
82113	1/2	32,5 x 26,5
82119	1/3	32,5 x 17,6
82129	1/4	26,5 x 16,2
82137	1/6	17,6 x 16,2
82159	1/9	17,6 x 10,8

Chafing Dish, GN Container & Transport



GN-Konvektomatenblech

GN-convection oven trays
GN cubeta para hornos de convección
GN bac pour fours à convection



Oberfläche mit schwarzer Antihafbeschichtung, schwere Qualität

coated black non stick, heavy quality
interior con revestimiento antiadherente negro, alta calidad
revêtement intérieur antiadhérent noir, haute qualité

	GN	↓ mm	cm
88246	1/1	20	53,0 x 32,5



GN-Konvektomatenblech - Emailliert

GN-convection oven trays enamelled
GN cubeta esmaltada para hornos de convección
GN bac émaillé pour fours à convection



beidseitig beschichtet mit schwarzer Granit-Emaille, gelochte Ecken, schwere Qualität

both sides coated with black granite enamel, perforated rim corners, heavy gauge
chapa de hierro esmaltada por ambas caras, color granito negro, borde con ángulos perforados, alta calidad
plaque acier émaillé intérieur et extérieur, granité noir, bord perforé dans les angles, qualité renforcée

	GN	↓ mm	cm
88244	1/1	20	53 x 32,5
88144	1/1	40	53 x 32,5
88245	1/1	65	53 x 32,5



Backblech

baking sheet
bandeja pastelera
plaque à pâtisserie



gelocht Ø 3 mm, Materialstärke 1,5 mm, Silikon beschichtet, temperaturbeständig bis 240°C

perforated Ø 3 mm, coated with silicon, heat resistant up to 240°C
aluminio con revestimiento de silicona perforada, resistente hasta 240°
aluminium avec revêtement silicone, perforée, température maxi 240°

	GN	cm
88285	1/1	53 x 32,5



GN Roste

GN grid
GN rejilla
GN grille



elektrolytisch poliert, Drahtstärke 3 mm, Rahmendraht 6 mm, extra schwere Qualität

electro-polished, wire thickness 3 mm, frame wire 6 mm, extra heavy quality
inox pulido electrolítico, grosor alambre 3 mm, grosor marco 6 mm, calidad reforzada
inox poli électrolytique, fil 3 mm, cadre 6 mm, qualité renforcée

	GN	cm
81199	2/1	65,0 x 53,0
81198	1/1	53,0 x 32,5
81796	2/3	32,5 x 35,4
81296	1/2	32,5 x 26,5



GN 1/3 Bestecksammler

GN 1/3 container
GN 1/3 cubeta
GN 1/3 bac



mit 2 Haken zum Einhängen an Servier- oder Transportwagen

container with 2 hooks, to hang on trolleys for cutlery
cubeta con 2 ganchos para cubiertos, a colgar del carro
bac à couverts avec 2 crochets, à accrocher au chariot

	GN	↓ mm	cm
11978	1/3	150	32,5 x 17,5



GN-Behälter

GN-container
GN cubetas
GN bac



	GN	↓ mm	ltr.	cm
82100	1/1	6	7,1	53,0 x 32,5
82200	1/2	6	3,4	32,5 x 26,5
82300	1/3	6	2,0	32,5 x 17,6
82306 NEW	2/3	6	4,6	35,4 x 32,5
82301 NEW	2/4	6	3,0	53,0 x 16,2



GN Tablett „FRAMES“

GN tray
GN bandeja
GN plateau



	GN	↑ cm	cm
82355	1/1	2	53,0 x 32,5
82356	1/2	2	32,5 x 26,5
82357	1/3	2	32,5 x 17,6



GN Tablett

GN tray
GN bandeja
GN plateau



	GN	↑ cm	cm
82201	1/1	2,5	53,0 x 32,5
82202	1/2	2,5	32,5 x 26,5
82203	1/3	2,5	32,5 x 17,6
82204	2/4	2,5	53,0 x 16,2
82205	2/3	2,5	35,4 x 32,5



GN Servier- / Buffetplatte

GN dish
GN bandeja bufé
GN plat buffet



	GN	↑ cm	cm
83301	1/1	2	53,0 x 32,5
83305	1/2	2	32,5 x 26,5
83304	1/3	2	32,5 x 17,5
83303	2/4	2	53,0 x 16,2

Chafing Dish, GN Container & Transport



hot price

GN 2/4

GN 1/1

GN 1/2

GN 1/4

GN 1/6

GN-Behälter „ECOLINE“

GN container

GN cubeta

GN bac



mit Stapelnocke

with notching edge

con borde marcado para el apilado

avec rebord pour l'empilage

	GN	↓ mm	ltr.	cm	Farbe / Colour
83759	1/1	65	7,10	53,0 x 32,5	White
83755	2/4	65	3,00	53,0 x 16,2	White
83757	1/2	65	3,40	32,5 x 26,5	White
83753	1/3	65	2,00	32,5 x 17,6	White
83751	1/4	65	1,35	26,5 x 16,2	White
83749	1/6	65	0,80	17,6 x 16,2	White

	GN	↓ mm	ltr.	cm	Farbe / Colour
83758	1/1	65	7,10	53,0 x 32,5	Black
83754	2/4	65	3,00	53,0 x 16,2	Black
83756	1/2	65	3,40	32,5 x 26,5	Black
83752	1/3	65	2,00	32,5 x 17,6	Black
83750	1/4	65	1,35	26,5 x 16,2	Black
83748	1/6	65	0,80	17,6 x 16,2	Black

	GN	↓ mm	ltr.	cm	Farbe / Colour
84300	1/1	100	10,6	53,0 x 32,5	White
84302	2/4	100	4,3	53,0 x 16,2	White
84301	1/2	100	4,7	32,5 x 26,5	White
84303	1/3	100	2,7	32,5 x 17,6	White
84304	1/4	100	1,9	26,5 x 16,2	White
84305	1/6	100	1,0	17,6 x 16,2	White

	GN	↓ mm	ltr.	cm	Farbe / Colour
84306	1/1	100	10,6	53,0 x 32,5	Black
84308	2/4	100	4,3	53,0 x 16,2	Black
84307	1/2	100	4,7	32,5 x 26,5	Black
84309	1/3	100	2,7	32,5 x 17,6	Black
84310	1/4	100	1,9	26,5 x 16,2	Black
84311	1/6	100	1,0	17,6 x 16,2	Black



GN-Deckel

GN-lid

GN tapa

GN couvercle



	GN	cm
82001	1/1	53,0 x 32,5
82013	1/2	32,5 x 26,5
82019	1/3	32,5 x 17,6
82029	1/4	26,5 x 16,2
82037	1/6	17,6 x 16,2
82059	1/9	17,6 x 10,8



GN-Behälter „HIGHLINE“

GN-container
GN cubeta
GN bac



extrem bruchsticher, glänzende und harte Oberfläche, tiefkühlfest, keinen Temperaturschocks unterziehen, nicht auf heißen Flächen liegen lassen, mit Stapelnocke
durable, top quality, hard and glossy surface, avoid thermal shocks, do not leave on hot surfaces, with notching edge
duradera, alta calidad, superficie brillante y resistente, hay que evitar los cambios térmicos bruscos, no apoyar en superficies calientes, con borde para apilamiento
durable, haute qualité, surface brillante et résistante, éviter les chocs thermiques et ne pas poser sur une surface chaude, encoche pour une louche

	GN	↓ mm	ltr.	cm
83772	1/1	65	7,10	53,0 x 32,5
83770	2/3	65	4,60	35,0 x 32,5
83768	1/2	65	3,40	32,5 x 26,5
83766	2/4	65	3,00	53,0 x 16,2
83764	1/3	65	2,00	32,5 x 17,6
83762	1/4	65	1,35	26,5 x 16,2
83760	1/6	65	0,80	17,6 x 16,2

	GN	↓ mm	ltr.	cm
83773	1/1	100	11,0	53,0 x 32,5
83769	1/2	100	5,50	32,5 x 26,5
83765	1/3	100	3,15	32,5 x 17,6
83763	1/4	100	2,20	26,5 x 16,2
83761	1/6	100	1,25	17,6 x 16,2



„SYSTEM-THEKE“

system-counter
Sistema para mostrador
Système-Comptoir



	cm	↑ cm	ltr.	Farbe / Colour
84050	22 x 14,5	2		White
84053	22 x 14,5	9	1,7	White
84059	29 x 22,0	4	1,3	White
84062	29 x 29,0	2		White
84066	44 x 22,0	2		White
84069	44 x 29,0	2		White

	cm	↑ cm	ltr.	Farbe / Colour
84150	22 x 14,5	2		Black
84153	22 x 14,5	9	1,7	Black
84159	29 x 22,0	4	1,3	Black
84162	29 x 29,0	2		Black
84166	44 x 22,0	2		Black
84169	44 x 29,0	2		Black



Deckel „SYSTEM-THEKE“, mit Löffelaussparung

cover, with notched for spoons
tapa, con espacio para la cuchara
couverture avec encoche pour la cuillère



	cm
84054	22 x 14,5
84058	22 x 22,0
84061	29 x 22,0
84065	29 x 29,0
84068	44 x 22,0

STOP-TOOLS

Die STOP-Funktion verhindert, dass Gabel oder Löffel in das Gefäß rutschen.

The smart STOP-function prevent forks and spoon not to slip into the vessel.

La función STOP evita que los cubiertos se caigan dentro del recipiente.
Antideslizante.

La fonction STOP empêche les couverts de glisser dans le récipient.



Servierlöffel

serving spoon
cuchara de servicio
cuillère de service



Materialdicke 2,5 mm, ergonomischer, rutschfester Griff
ergonomic antislip handle
mango ergonómico antideslizante
manche ergonomique antidérapante

	cm	→ cm
00834	10 x 7,5	37,5



Servierlöffel geschlitzt

slotted spoon
cuchara de servicio
cuillère de service



Materialdicke 2,5 mm, ergonomischer, rutschfester Griff
ergonomic antislip handle
mango ergonómico antideslizante
manche ergonomique antidérapante

	cm	→ cm
00833	10 x 7,5	37,5



Schöpflöffel

ladle
cucharón
louche



Materialdicke 2,5 mm, ergonomischer, rutschfester Griff
ergonomic antislip handle
mango ergonómico antideslizante
manche ergonomique antidérapante

	Ø cm	→ cm
00832	9	35



Fleischgabel

meat fork
tenedor de carne
fourchette à viande



Materialdicke 2,5 mm, ergonomischer, rutschfester Griff
ergonomic antislip handle
mango ergonómico antideslizante
manche ergonomique antidérapante

	cm	→ cm
00831	10,5	38,5



Servierlöffel

serving spoon
cuchara de servicio
cuillère de service



ergonomischer, rutschfester Griff
ergonomic antislip handle
mango ergonómico antideslizante
manche ergonomique antidérapante

.....
cm → cm
00662 10,5 x 7 34



Servierlöffel gelocht

serving spoon
cuchara de servicio
cuillère de service



ergonomischer, rutschfester Griff
ergonomic antislip handle
mango ergonómico antideslizante
manche ergonomique antidérapante

.....
cm → cm
00664 10,5 x 7 34



Bratenwender

slotted turner
espátula para plancha
spatule pour le grill



ergonomischer, rutschfester Griff
ergonomic antislip handle
mango ergonómico antideslizante
manche ergonomique antidérapante

.....
cm → cm
00668 10 x 8 36



Schöpflöffel

ladle
cucharón
louche



ergonomischer, rutschfester Griff
ergonomic antislip handle
mango ergonómico antideslizante
manche ergonomique antidérapante

.....
cm → cm ltr.
00670 9 x 9 34 0,15



Fleischgabel

meat fork
tenedor de carne
fourchette à viande



ergonomischer, rutschfester Griff
ergonomic antislip handle
mango ergonómico antideslizante
manche ergonomique antidérapante

.....
cm → cm
00666 7 / 10 34



Schöpflöffel „PROFI“

ladle
cacillo
louche



	∅ cm	→ cm	ltr.
00710	5	32,0	0,030
00711	6	34,0	0,050
00712	7	35,5	0,080
00713	8	38,0	0,125
00714	9	42,0	0,150
00715	10	43,5	0,250
00716	11	45,0	0,300
00717	14,5	48,0	0,550



Schaumlöffel „PROFI“

skimmer
espumadera
écumoire



	∅ cm	→ cm
00720	8	37,0
00721	10	40,5
00722	12	46,0
00723	14	50,5



Wender „PROFI“

turner
espátula
spatule



	cm	→ cm
00730	10 x 11,5	52



Servierlöffel „PROFI“

serving spoon
cuchara de servicio
cuillère de service



	cm	→ cm	
00671	10,5 x 7	41	geschlitzt / slotted
00672	10,5 x 7	41	



Spaghettilöffel „PROFI“

spaghetti spoon
cuchara de espaguetis
cuillère à spaghettis



	cm	→ cm
00673	11 x 6,5	39



Salat- / Servierlöffel „BANQUET“

salad spoon / serving spoon
cuchara para ensalade / cuchara de servicio
cuillère à salade / cuillère de service



	cm	→ cm
00588	6,0 x 5	23,5
00590	7,5 x 6	29,0

Salatgabel „BANQUET“

salad fork
tenedor de servicio para ensalada
fourchette de service pour la salade



	cm	→ cm
00589	6,0 x 5	23,5
00591	7,5 x 6	29,0

Chafing Dish Löffel „BANQUET“

serving spoon
cuchara para servir
cuiller de service



	cm	→ cm	
00592	11 x 6,5	35	
00593	11 x 6,5	35	geschlitzt / slotted

Dressinglöffel „BANQUET“

dressing spoon
cuchara de aliño
cuillère à vinaigrette



	cm	→ cm
00594	6 x 4	34

Schöpflöffel „BANQUET“

ladle
cucharón
louche



	cm	→ cm
00595	8,5 x 7,5	31

Fleischgabel „BANQUET“

meat fork
tenedor de carne
fourchette à viande



	→ cm
00596	21

Serviergabel „BANQUET“

fork
tenedor de servicio
fourchette de service



	→ cm
00597	31

Besteckablage

cutlery rest
reposa cuchara
pose-cuillère



	cm	↑ cm
00650	27 x 11	3,5

THERMO-BOX



Thermo-Box - Komplett-Lösung für Gastronomie, Catering und Partyservice



GN 1/1 System-Thermo-Box



beste Isoliereigenschaften, hygienisch, empfohlen nach HACCP, einsetzbar von -40° bis +120°C, mit Beschriftungsfeld, jede Box ist als Deckel- und Bodenteil verwendbar
 best isolation quality, hygienic, HACCP standards, usable from -40°C to +120°C, stackable, each box can be used as a lid for the lower box
 apilable, aislante, irrompible, higiénico, HACCP stantard de -40° hasta + 120°C, al apilar se puede usar otra caja arriba como tapa, y así sucesivamente
 excellente isolation, hygiénique, recommandé HACCP, utilisable entre -40°C et +120°C, empilables une boîte sur l'autre, la boîte supérieur sert alors de couvercle

	cm	↑ cm	
11312	59,5 x 39	12,0	Nutzhöhe 8 cm / usability height 8 cm altura hasta 8 cm / hauteur utile maxi 8 cm
11315	59,5 x 39	16,5	Nutzhöhe 12 cm / usability height 12 cm altura hasta 12 cm / hauteur utile maxi 12 cm
11319	59,5 x 39		Zusatzdeckel, flach / extra cover, low tapa extra, baja / couvercle extra, plat

passende System-Tabletts / matching system-tray / bandeja con systema / plat avec système

	GN	cm
11300	1/1	53 x 32,5

	GN	cm
11290	1/1	53 x 32,5

	GN	cm
83980	1/1	53,0 x 32,5



Thermo-Box „UNIVERSAL“



beste Isoliereigenschaften, hygienisch, empfohlen nach HACCP, einsetzbar von -40°C bis +120°C, mit Beschriftungsfeld, jede Box ist als Deckel- und Bodenteil verwendbar
 best isolation quality, hygienic, HACCP standards, usable from -40°C to +120°C, stackable, each box can be used as a lid for the lower box

	cm	↑ cm	ltr.
49258	68,5 x 48,5	36	80



Thermo-Box „GN 1/1“



beste Isoliereigenschaften, hygienisch, empfohlen nach HACCP, einsetzbar von -40°C bis +120°C, mit Beschriftungsfeld, jede Box ist als Deckel- und Bodenteil verwendbar
 best isolation quality, hygienic, HACCP standards, usable from -40°C to +120°C, stackable, each box can be used as a lid for the lower box

	cm	↑ cm	ltr.
49638	59,5 x 39	28	38



Thermo-Box „PIZZA“



beste Isoliereigenschaften, hygienisch, empfohlen nach HACCP, einsetzbar von -40°C bis +120°C, mit Beschriftungsfeld, jede Box ist als Deckel- und Bodenteil verwendbar
 best isolation quality, hygienic, HACCP standards, usable from -40°C to +120°C, stackable, each box can be used as a lid for the lower box

	cm	↑ cm	ltr.
49738	41,0 x 41,0	37,5	37,5



Thermo-Box „HOT COOL“



beste Isoliereigenschaften, hygienisch, empfohlen nach HACCP, einsetzbar von -40°C bis +120°C, mit Beschriftungsfeld, jede Box ist als Deckel- und Bodenteil verwendbar
 best isolation quality, hygienic, HACCP standards, usable from -40°C to +120°C, stackable, each box can be used as a lid for the lower box

	cm	↑ cm	ltr.
49310	38,0 x 30,0	13	7,5



Servier- / Transportwagen

serving trolley
carro de servicio
chariot de service



Gestell aus Vierkantröhr 25 x 25 mm, Ablagefläche innen 84 x 44,5 cm, Bodenfläche 90 x 50 cm, auf Unterseite schalldämmend beschichtet, Abstand zwischen den Böden 28 cm / 29 cm, mit 4 Lenkrollen Ø 12,5 cm, alle mit Feststellern, Lieferung demontiert, einfache Montage, Tragfähigkeit 33 kg je Boden

frame rectangular bar 25 x 25 mm, shelf board inside 84 x 44,5 cm, shelf board outside 90 x 50 cm, undersurface coated sound-damping, distance between the boards 28 cm / 29 cm, with 4 swivel wheels Ø 12,5 cm, all with brakes, unassembled, simple assembly, max load 33 kg per shelf
estructura tubo cuadrado 25 x 25 mm, útiles int. por piso 84 x 44,5 cm. ext. al suelo 90 x 50 cm revestimiento para absorber ruidos distancia entre pisos 28 cm / 29 cm, 4 ruedas giratorias 12,50 cm, con frenos, se sirve desmontado, montaje fácil, carga máx. 33 kg por piso
structure en tube carré 25x25 mm, 3 niveaux dimensions utiles 84x44,5 cm, encombrement au sol 90x50 cm, avec revêtement en partie inférieure pour absorber le bruit, distance entre niveaux 28 cm / 29 cm, roues pivotantes 12,5 cm, avec frein, livré démonté, montage aisé, max. 33 kg de charge par niveau

	cm	↑ cm
71440	96 x 50	94



Servier- / Transportwagen

service trolley
carro de servicio
chariot de service



mit 3 Borden, Bordmaße ca. 83 x 51 cm, Abstand zwischen den Borden ca. 26 cm, Tragfähigkeit 120 kg, 4 Lenkrollen, davon 2 feststellbar, Lieferung demontiert, einfache Montage

with 3 trays, trays approx. 83 x 51 cm, size between the trays approx. 26 cm, total load capacity 120 kg, 4 wheels with 2 brakes, unassembled, simple assembly
con 3 bandejas inox mate, aprox. 83 x 51 cm, la medida entre bandejas aprox. 26 cm capacidad total 120 kg, 4 ruedas con 2 frenos, construcción robusta, montaje fácil
3 niveaux, approx. 83x51 cm chacun, distance entre niveaux 26 cm, capacité maxi 120 kg au total, 4 roues dont 2 avec frein, construction robuste, montage facile

	cm	↑ cm
11979	91 x 59	93



Servier- / Transportwagen

service trolley
carro de servicio
chariot de service



mit 2 Borden, Bordmaße ca. 83 x 51 cm, Abstand zwischen den Borden ca. 56 cm, Tragfähigkeit 80 kg, 4 Lenkrollen, davon 2 feststellbar, Lieferung demontiert, einfache Montage

with 2 trays, trays approx. 83 x 51 cm, size between the trays approx. 56 cm, total load capacity 80 kg, 4 wheels with 2 brakes, unassembled, simple assembly
con 2 bandejas de acero inoxidable mate, aprox. 83 x 51 cm, la medida entre bandejas aprox. 56 cm, capacidad total 80 kg, 4 ruedas, con 2 frenos, construcción robusta, montaje fácil
2 niveaux, approx. 83x51 cm chacun, distance entre niveaux 56 cm, capacité maxi 80 kg au total, 4 roues dont 2 avec frein, construction robuste, montage facile

	cm	↑ cm
11977	91 x 59	93



GN 1/1 Regalwagen

GN 1/1 trolley
carro GN 1/1
GN 1/1 chariot



mit 15 Doppelauflegeschieben, zum Transport von bis zu 30 GN-Tablets GN 1/2 oder 15 GN-Behältern bis GN 1/1 (Längseinschub), bei einem Stapelabstand von 75 mm, mit 4 Lenkrollen, 2 mit Feststellern, Tragfähigkeit 100 kg

15 double bars, for transporting up to 30 trays GN 1/2 or 15 GN-containers up to GN 1/1, size between the trays 75 mm, 4 swivel wheels, 2 equipped with brakes total load capacity 100 kg
15 pares de rieles dobles para el transporte de hasta 30 bandejas o 15 cubetas GN 1/1 (apertura por el lado estrecho) distancia entre las bandejas de 75 mm, 2 ruedas giratorias con frenos, carga máxima 100 kg

15 rails doubles pour maxi 30 plateaux GN 1/2 ou 15 plateaux GN 1/1 (ouverture sur le côté étroit 32,5cm), espace entre plateaux 75 mm, 2 roues pivotantes avec frein, charge maxi 100 kg

	cm	↑ cm
71441	55 x 38,5	173,5



mit beidseitiger Kipp- und Durchschubsicherung



Servier- / Transportwagen

serving trolley
carro de servicio
chariot de service



Aluminiumrahmen, 3 Böden, Abstand zwischen den Böden 31 cm, mit 4 Lenkrollen, alle mit Feststellern, Tragfähigkeit: ca. 150 kg je Boden, 450 kg insgesamt, demontiert, einfache Montage, Lieferung ohne Container und Dekoration

frame aluminium, 3 shelves, distance between shelves 31 cm, 4 swivel wheels, all equipped with brakes, max. load per shelf 150 kg, 450 kg total, demounted, easy to mount, delivery without containers and decoration

marco aluminio, 3 pisos, distancia entre cada piso 31 cm, 4 ruedas giratorias, las 4 con frenos, carga máxima por bandeja 150 kg, 450 kg en total, se sirve desmontado, fácil de montar (se entrega sin contenedores ni decoración)

chassis aluminium, 3 étages, distance entre niveaux 31 cm, 4 roues pivotantes, toutes avec frein, charge maximum 150 kg par niveau, 450 kg au total, livré démonté, montage facile (livré sans récipients ni décoration)

	cm	↑ cm
11945	108 x 50	96



Container

container
contenedor
récipient



zum Einhängen, passend zum Servier- / Transportwagen 11945

to hang up, suitable serving trolley 11945

para colgar, adaptado para el carro ref. 11945

à suspendre, pour chariot de service 11945

	cm	↑ cm	ltr.
11946	33 x 23	56,5	42
11947	33 x 23	17,5	13



GN 1/1 Besteckbehälter

GN 1/1 dispenser GN
GN 1/1 dispensador de cubiertos
GN 1/1 bac à couverts



in Handarbeit geflochten, 4 Mulden, Kunststoff-Geflecht, Drahtgestell, braun-schwarz wickerwork, 4 compartments, with reinforced chromed wire structure, brown-black cesta trensada a mano, 4 compartimentos, de plástico, con bastidor cromado reforzado, marrón oscuro corbeille tressée à main, 4 compartiments, en plastique, cadre acier chromé renforcé, couleur marron foncé

	cm	↑ cm	Farbe / Colour
11966	53 x 32,5	9	



GN 1/1 Besteckbehälter „BUFFET“

GN 1/1 cutlery dispenser
GN 1/1 dispensador de cubiertos
GN 1/1 bac à couverts



4 Mulden, Kunststoff-Geflecht, Drahtgestell, beige
4 troughs, wickerwork, wire, beige
4 huecos, trabajo de cestería
4 compartiments, plastique tressé, cadre acier chromé renforcé, couleur osier naturel

	cm	↑ cm	Farbe / Colour
11965	53 x 32,5	10	



GN 1/1 Besteckbehälter

GN 1/1 cutlery tray / box stand
GN 1/1 dispensador de cubiertos
GN 1/1 bac à couverts



	cm	↑ cm	Farbe / Colour
11955	53 x 32,5	10	
11957	53 x 32,5	10	



GN 1/1 Besteckkasten

cutlery box GN 1/1
GN 1/1 dispensador de cubiertos
GN 1/1 bac à couverts



	cm	↑ cm	Farbe / Colour
11960	53 x 32,5	10	
11962	53 x 32,5	10	





Besteckständer „TRIPLE TOWER“

cutlery basket
cesta para cubiertos
égouttoir á couverts



4-teiliges Set: 1 Gestell + 3 Köcher
4 pcs. set: 1 frame + 3 baskets
set de 4 piezas: 1 estructura + 3 cubiertos
set de 4 éléments: 1 structure + 3 corbeille

	cm	↑ cm	Farbe / Colour
11466	18 x 26	43	
11467	18 x 26	43	



variable Nutzungsmöglichkeiten
variable usage possibilities



Tisch-Set „VARIO I“

table set
set de mesa
set de table



4-teilig: 1 Ständer + 1 Behälter (innen Ø 7 cm) für Tischreste + 2 Behälter (innen Ø 9 cm) für Besteck, Servietten etc., vielseitig einsetzbar

4 pcs. set: 1 stand + 1 table garbage bin (inner Ø 7 cm) + 2 bins (inner Ø 9 cm) for cutlery, napkins etc., versatile applicable
4 piezas: 1 soporte + 1 papelera Ø 7 cm de sobremesa + 2 recipientes Ø 9 cm para cubiertos, servilletas etc.
4 éléments: 1 support + 1 poubelle de table Ø 7 cm + 2 récipients Ø 9 cm pour couverts, serviettes, etc.

	cm	↑ cm
11925	22 x 22	26

Einzel-Behälter / only container / sólo contenedor / récipient seul

	Ø cm	↑ cm
83998	13 / 7	14
83999	13 / 9	14



Tisch-Set „VARIO II“

table set
set de mesa
set de table



4-teilig: 1 Ständer + 3 Behälter (innen Ø 9 cm) für Besteck, Servietten etc., vielseitig einsetzbar

4 pcs. set: 1 stand + 3 bins (inner Ø 9 cm) for cutlery, napkins etc., versatile applicable
4 piezas: 1 soporte + 3 recipientes Ø 9 cm para cubiertos, servilletas etc.
4 pièces: 1 support, 3 récipients Ø 9 cm, pour couverts, serviettes,...

	cm	↑ cm
11927	22 x 22	26

Einzel-Behälter / only container / sólo contenedor / récipient seul

	Ø cm	↑ cm
83998	13 / 7	14
83999	13 / 9	14



Besteckbehälter „ELEMENT“

cutlery bin
recipiente para cubiertos
récipients pour couverts



mit Abflussloch, mit Besteck Logo, Bodeneinlagen aus Silikon zum Schonen der Messerspitzen, möbelschonende Unterseite
with drain hole, with cutlery logo, silicone floor inserts for saving the points of knives, with non-scratching undersurface
con orificio de drenaje, con logotipo de cubertería, soporte de silicona para proteger las puntas de los cuchillos, con base antirrayaduras
avec le trou de drainage, avec le logo de coutellerie, insert de silicone pour protéger les pointes des couteaux, avec base revêtue antirayures

	Ø cm	↑ cm
00018	11	14



Besteckbehälter

cutlery basket
dispensador de cubiertos
présentoir à couverts



matt poliert
satin polished finish
inox mate (sin cubiertos)
inox mat

	cm	↑ cm	
11994	26,0 x 30 Ø 10	20	4 Löcher inkl. Köcher (Kunststoff) 4 holes incl. dispensers (plastic) 4 agujeros incl. dispensador plástico 4 places, avec 4 récipients (plastique)
11996	26,0 x 30 Ø 10	20	4 Löcher ohne Köcher 4 holes without dispensers 4 agujeros sin dispensador de plástico 4 places, sans récipients
11997	37,5 x 30 Ø 10	20	6 Löcher ohne Köcher 6 holes without dispensers 6 agujeros sin dispensador de plástico 6 places, sans récipients



Besteckbehälter

cutlery basket
recipiente para cubiertos
récipients pour couverts



4 Löcher inkl. 4 Edelstahl Köcher
4 holes incl. 4 stainless baskets
4 agujeros, incl. 4 cestas de acero
4 places, avec 4 corbeille inox

	cm	↑ cm	Farbe / Colour
93321	27 x 27	15	■



Besteckköcher

cutlery basket
cesta para cubiertos
corbeille à couverts



	Ø cm	↑ cm	
11998	9,7	13,7	Kunststoff weiß / white plastic plástico blanco / plastique blanc
11999	9,7	13,7	matt poliert / satin polished finish acero inoxidable / inox



Besteckkorb „ECONOMIC“

cutlery dispenser
dispensador de cubiertos
corbeille à couverts



in Handarbeit geflochten
wickerwork
trensado a mano
tressage à main

	Ø cm	↑ cm	Farbe / Colour
40130	12	15	
40007	12	15	
40012 <small>NEW</small>	12	15	
40013 <small>NEW</small>	12	15	



Besteckkorb „ECONOMIC“

cutlery dispenser
dispensador de cubiertos
corbeille à couverts



in Handarbeit geflochten
wickerwork
trensado a mano
tressage à main

	cm	↑ cm	Farbe / Colour
40131	27 x 10	4,5	
40009	27 x 10	4,5	
40010 <small>NEW</small>	27 x 10	4,5	
40011 <small>NEW</small>	27 x 10	4,5	



Sortierbox „MULTI“

shape sorter
caja surtida
boîte de tri



inklusive 3 herausnehmbare Trennwände, 4 Kammern
including 3 removable divider, 4 chambers
con 3 divisores extraíbles, 4 compartimentos
avec 3 parois de séparation amovibles, 4 compartiments

	cm	↑ cm	ltr.	Farbe / Colour
84531	31,5 x 17,5	7	2,1	
84532	31,5 x 17,5	7	2,1	

Chafing Dish, GN Container & Transport



Besteckköcher
cutlery basket
cesta para cubiertos
corbeille à couverts



	cm	↑ cm	Farbe / Colour
84535	12 x 12	16	White
84536	12 x 12	16	Black



Besteckständer
cutlery basket
cesta para cubiertos
égouttoir à couverts



matt poliert
satin polished finish
inox mate (sin cubiertos)
inox mat

	Ø cm	↑ cm
11923	12,5	15,5



Besteckständer
cutlery basket
cesta para cubiertos
égouttoir à couverts



	Ø cm	↑ cm
11921	10	10,0
11922	12	13,5



Eier-Box
eggs box
caja para huevos
boîte à oeufs



mit luftdichtem Deckel, für 4 Lagen à 30 Eier, Lieferung inkl. 8 Lagen, Größe Lage: 28 x 28 cm
with airtight cover, capacity: 4 trays of 30 eggs, delivery with 8 trays, size of tray: 28 x 28 cm
capacidad para 4 bandejas de 30 huevos, tapa hermética, se entrega con 8 bandejas, formato bandejas 28 x 28 cm, apto para lavavajillas
pour 4 plateaux de 30 oeufs chacun, apte pour 4 plateaux plats, couvercle hermétique, livré avec 8 plateaux, dimension plateau 28x28 cm, lavable en lave-vaisselle

	cm	↑ cm	GN
82419	35,4 x 32,5	20	2/3

10 Lagen / 10 trays / 10 bandejas / 10 plateaux

82420



Rechteckschalen
container
cubeta
bac



	cm	↑ cm	ltr.
11941	30 x 21,0	6,5	2
11942	34 x 23,5	7,0	3
11943	48 x 33,0	8,0	8



stabile Ausführung
robust

Wanne
container
cubeta
bac



	cm	↑ cm	ltr.
11940	61 x 44	15	25



Geschirrwanne
container
cubeta para vajilla
bac à vaisselle



	cm	↑ cm
11950	55 x 42	14



00502

Serviertablett „RUTSCHFEST“

tray non-slip
bandeja antideslizante
plateau antiglisse



rutschfeste Oberfläche
non-slip surface
superficie anti-deslizante
surface antidérapante

	cm	↑ cm	GN	Farbe / Colour
00502	53,0 x 32,5	1,5	1/1	
00508	46,0 x 36,0	2		
00505	53,0 x 32,5	1,5	1/1	
00503	53,0 x 37,0	1,5		



00552

00553

00554

00555

Fast Food-Tablett

snack tray
bandeja autoservicio y snacks
plateau self-service et snacks



	cm	↑ cm	GN	Farbe / Colour
00530	35 x 27	2		
00535	41 x 30,5	2		
00540	45 x 35,5	2		
00552	53,0 x 32,5	2	1/1	

	cm	↑ cm	GN	Farbe / Colour
00531	35 x 27	2		
00536	41 x 30,5	2		
00541	45 x 35,5	2		
00553	53,0 x 32,5	2	1/1	

	cm	↑ cm	GN	Farbe / Colour
00532	35 x 27	2		
00537	41 x 30,5	2		
00542	45 x 35,5	2		
00554	53,0 x 32,5	2	1/1	

	cm	↑ cm	GN	Farbe / Colour
00533	35 x 27	2		
00538	41 x 30,5	2		
00543	45 x 35,5	2		
00555	53,0 x 32,5	2	1/1	





Bar & Café

Sektkühler
Shaker
Barmaß
Aschenbecher
Tabletts

cubitera para cava
coctelera
medidor jigger
cenicero
bandejas

champagne bowls
shaker
jigger
ashtrays
trays

seau à champagne
shaker
mesure jigger
cendrier
plateaus



Wein- / Sektkühler

wine / champagne bowl
 cubitera para vino y cava
 seau à vin ou champagne

mit seitlichen Griffen, transparent
 with lateral handles, transparent
 con asas laterales
 avec poignées latérales



	cm	↑ cm	ltr.	Farbe / Colour
36087	32 x 21,5	24,5	7	
36088	32 x 21,5	24,5	7	
36089	32 x 21,5	24,5	7	



Flaschenkühler / Getränkeschale

bottle cooler / bowl
 enfriador de botella
 rafraîchisseur de bouteille

mit seitlichen Griffen, transparent
 with lateral handles, transparent
 con asas laterales
 avec poignées latérales



	cm	↑ cm	ltr.
36082	35,5 x 35,5	20	16



Wein- / Sektkühler

wine / champagne bowl
 cubitera para vino y cava
 seau à vin ou champagne

mit seitlichen Griffen, transparent
 with lateral handles, transparent
 con asas laterales
 avec poignées latérales



	cm	↑ cm	ltr.
36081	20 x 20	20	4,5



Wein- / Sektkühler

wine / champagne bowl
 cubitera para vino y cava
 seau à vin ou champagne

glasklarer Rand, transparent gefrostet
 edge transparent, body transparent frosted
 borde transparente, cuerpo transparente efecto glaseado
 bord transparent, corps finition mate



	Ø cm	↑ cm	ltr.
36066	22 / 14	23	4



Wein- / Sektkühler

wine / champagne bowl
cubitera para vino y cava
seau à vin ou champagne



innen mattiert, außen hochglanz, mit massiven Knopf-Griffen, extra stabiler eingerollter Rand, schwere Ausführung
outside mirror polished finish, inside satin polished finish, with solid knob handles, rolled edge, heavy quality
acabado pulido brillante, asas de botón robustas, borde redondeado, alta calidad
brillant, 2 poignées robuste en forme de bouton, bord arrondi, haute qualité

	Ø cm	↑ cm	litr.
36028	21,5 / 16	22	4



Wein- / Sektkühler

wine / champagne bowl
cubitera para vino y cava
seau à vin ou champagne



innen mattiert, außen poliert, mit massiven Griffen, Rand eingerollt
outside mirror polished finish, inside satin polished finish, with massive handles, rolled edge
pulido mate, 2 asas macizas, borde redondeado
finition mate, 2 anses massives, bord rond

	Ø cm	↑ cm	litr.
36025	21 / 15	21	3,5



Wein- / Sektkühler „HAMMERSCHLAG“

wine / champagne bowl
cubitera para vino y cava
seau à vin ou champagne



hochglanzpoliert, mit massiven Ring-Griffen, eingerollter Rand
mirror polished finish, with solid ring handles, rolled edge, hammered
acabado pulido brillante, con 2 anillos macizos, borde redondeado, repujado
brillant, 2 anneaux massifs, bord arrondi, surface martelée

	Ø cm	↑ cm	litr.
36026	21 / 17	21,5	4



Wein- / Sektkühler

wine / champagne bowl
cubitera para vino y cava
seau à vin ou champagne



matt poliert, Hohlgriffe
satin polished finish, hollow handles
acabado pulido satinado, con asas huecas
finition mate, 2 boutons creux

	Ø cm	↑ cm	litr.
36021	20 / 15	20,5	4



Wein- / Sektkühler

wine / champagne bowl
cubitera para vino y cava
seau à vin ou champagne



aussen hochglanzpoliert, innen matt poliert, mit Ring-Griffen
outside mirror polished finish, inside satin polished finish, with ring handles
exterior pulido brillante, interior efecto satinado con 2 asas anillos
extérieur brillant, intérieur satin, avec 2 anneaux

	Ø cm	↑ cm	litr.
36020	20 / 15	19	3



Mini-Eiseimer / Mini-Sektkühler

ice bucket
cubitera clásica
seau à glaçons classique



ideal zum Servieren kleiner Mengen Eiswürfel o. zum Aufbewahren im Bar-/Thekenbereich
ideal for serving small amounts of ice cubes or for storing in the bar/counter area
ideal para servir pequeñas cantidades de cubitos de hielo o para almacenar en el bar/la barra
idéal pour servir de petites quantités de cubes de glace ou pour le stockage dans le bar

	Ø cm	↑ cm	ltr.
36003	10,5	10	0,65
36004	13	13	1,0



Ständer für Wein- / Sektkühler

stand for wine / champagne bowl
pie porta champañera / vino
ped pour seau à champagne / vin



hochglanzpoliert, schwerer standsicherer Fuß, Innendurchmesser der Schale Ø 17,5 cm
mirror polished finish, heavy foot, inner bowl Ø 17,5 cm
acabado pulido efecto brillante, bol interior de Ø 17,5 cm
brillant, intérieur support Ø 17,5 cm

	Ø cm	↑ cm
36069	17,5 / 26,5	73



Wein- / Sektkühler no. 36028

wine / champagne bowl no. 36028
cubitera para vino y cava no. 36028
seau à vin ou champagne no. 36028

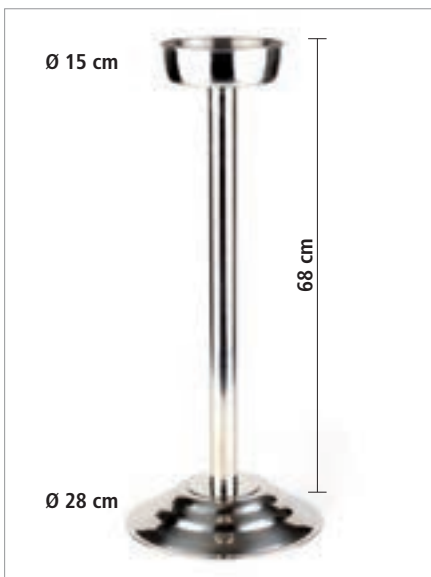

Ständer für Wein- / Sektkühler

stand for wine / champagne bowl
pie porta champañera / vino
ped pour seau à champagne / vin



hochglanzpoliert, schwerer standsicherer Fuß, Innendurchmesser der Schale Ø 15 cm
mirror polished finish, heavy foot, inner bowl Ø 15 cm
acabado pulido efecto brillante, bol interior de Ø 15 cm
brillant, intérieur support Ø 15 cm

	Ø cm	↑ cm
36068	15 / 28	68



Tischhalterung für Sektkühler

Champagne Bucket Table holder
soporte champañera universal
porte-seau à champagne



aus 8 mm starkem Stahldraht, passen zu allen lieferbaren Sektkühlern, innen Ø-Ring: 18 cm
8 mm chrome plated wire, suitable for all available champagne buckets
alambre cromado 8 mm, para todas las champañeras
fil chromé 8 mm, pour tous les seaux à champagne

	cm	↑ cm
30332	49 x 20	17



Champagnerkühler „CHAMPION“

champagne bowl
champañera
seau à champagne



hochglanzpoliert, doppelwandig
mirror polished finish, double wall
acabado pulido brillante con doble pared
brillant, double paroi

	Ø cm	↑ cm	litr.
36076	44	32	15



Champagnerkühler

champagne bowl
cubo champañera
seau à champagne

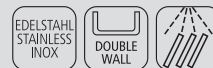

hochglanzpoliert, doppelwandig
mirror polished finish, double wall
acabado pulido brillante con doble pared
brillant, double paroi

	Ø cm	↑ cm	litr.
36044	44 / 25	24	10,5



Flaschenkühler „BRIDGE“

bottle cooler
champañera de bufé
seau à champagne

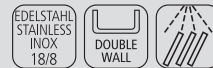

doppelwandig für beste Isolierung, außen poliert, innen mattiert
double wall cooler keeps the temp. for a long time, outs. mirror polished, inside matt finish
champañera inox de doble pared, interior mate, exterior brillante
seau inox double paroi, maintient le froid plus longt., intérieur mat, extérieur poli brillant

	Ø cm	↑ cm	litr.
36077	31	19	10



Konferenzkühler „BRIDGE“ no. 13985

bottle cooler no. 13985
enfriador no. 13985
rafraîchisseur no. 13985



Champagnerkühler

champagne bowl
cubo champañera
seau à champagne



außen hochglanzpoliert, innen matt poliert, mit vergoldeten Griffen
outside mirror polished finish, inside satin polished finish, with gold plated handles
exterior pulido brillante, interior satinado
extérieur brillant, intérieur satin

	Ø cm	↑ cm	litr.
36047	42 / 27	28	20



Champagnerkühler

champagne bowl
champañera
seau à champagne



glasklar
transparent
transparente
transparent

	Ø cm	↑ cm	ltr.
36049	44 / 26	25	15



Champagnerkühler

champagne bowl
cubo champañera
seau à champagne



hochglanzpoliert, Lieferung ohne Gläser-Ring
mirror polished finish, delivery without holder
acabado efecto brillante, se entrega sin el aro colgador para copas
brillant, livré sans le support à flûtes

	Ø cm	↑ cm	ltr.
36045	40,5 / 27,5	22,5	13,5



Champagnerkühler

champagne bowl
cubo champañera
seau à champagne



hochglanzpoliert, Rand matt poliert
mirror polished finish, edge satin polished finish
acabado pulido brillante, borde satinado
brillant, bord mat

	Ø cm	↑ cm	ltr.
36046	45 / 21	23	12



Wein- / Sektkühler

wine / champagne bowl
cubitera para vino y cava
seau à vin ou champagne



glasklar, für bis zu 6 Flaschen geeignet
transparent, suitable for up to 6 bottles
transparente para máximo de 6 botellas
transparent, maxi 6 bouteilles

	cm	↑ cm	ltr.
36057	47 x 28	23	10



36048

Wein- / Sektkühler
 wine / champagne bowl
 cubitera para vino y cava
 seau à vin ou champagne



mit 2 seitlichen Eingriffen
 with 2 handles on the side
 con 2 asas
 avec 2 poignées

	cm	↑ cm	ltr.	Farbe / Colour
36048	35 x 27	25,5	6	White
36052	27 x 20	21	3	White



36054

Wein- / Sektkühler
 wine / champagne bowl
 cubitera para vino y cava
 seau à vin ou champagne



mit 2 seitlichen Eingriffen
 with 2 handles on the side
 con 2 asas
 avec 2 poignées

	cm	↑ cm	ltr.	Farbe / Colour
36054	35 x 27	25,5	6	Black
36053	27 x 20	21	3	Black



Wein- / Sektkühler
 wine / champagne bowl
 cubitera para vino y cava
 seau à vin ou champagne



glasklar, für zwei Flaschen
 transparent, for two bottles
 transparente, para 2 botellas
 transparent, pour 2 bouteilles

	cm	↑ cm	ltr.
36056	30,5 x 21,5	26	4



Wein- / Sektkühler
 wine / champagne bowl
 cubitera para vino y cava
 seau à vin ou champagne



glasklar, mit Tragegriff
 transparent, handle on the side
 transparente, con un asa en el lateral
 transparent, avec poignée

	cm	↑ cm	ltr.
36055	23 x 22	27,5	3



Flaschenkühler „COPPER“

bottle cooler
enfriador de botella
rafraîchisseur de bouteille



Hammerschlagoptik, doppelwandig für beste Isolierung, für 0,7 - 1,5 Liter-Flaschen
double wall cooler keeps the temperature for a long time, hammered look, for 0,7 - 1,5 ltr. bottles
doble pared para mantener el frío largo tiempo, botellas de 0,7 - 1,5 ltr.
double paroi pour une meilleure conservation de la température, pour bouteilles de 0,7 à 1,5 l.

	Ø cm	↑ cm	Farbe / Colour
36074	12 / 10	20	



1:1 Oberflächenansicht
1:1 structural view



Flaschenkühler „LINES“

bottle cooler
enfriador de botella
rafraîchisseur de bouteille



matt poliert, doppelwandig für beste Isolierung, für 0,7 - 1,5 Liter-Flaschen
satin polish. finish, doub. wall cooler keeps the temper. for a long time, for 0,7 - 1,5 ltr. bottles
acero inoxidable mate con doble pared para mantener el frío largo tiempo, botellas de 0,7 - 1,5 ltr.
inox mat, double paroi pour une meilleure conserv. de la tempér., pour bouteilles de 0,7 à 1,5 l.

	Ø cm	↑ cm
36002	12 / 10	20



1:1 Oberflächenansicht
1:1 structural view



Flaschenkühler

bottle cooler
enfriador de botella
rafraîchisseur de bouteille



matt poliert, doppelwandig für beste Isolierung, für 0,7 - 1,5 Liter-Flaschen
satin polished finish, double wall cooler keeps the temperature for a long time, for 0,7 - 1,5 ltr. bottles
acero inoxidable mate con doble pared para mantener el frío largo tiempo, botellas de 0,7 - 1,5 ltr.
inox mat, double paroi pour une meilleure conservation de la température, pour bouteilles de 0,7 à 1,5 l.

	Ø cm	↑ cm
36030	12 / 10	20



Flaschenkühler

bottle cooler
enfriador de botella
rafraîchisseur de bouteille



matt poliert, taillierte Form, doppelwandig für beste Isolierung, für 0,5 - 1,5 Liter-Flaschen
satin polished finish, waisted form, double wall, for 0,5 - 1,5 ltr. bottles
acabado pulido mate, diseño „entallado“, con doble pared para botellas de 0,5 a 1,5 ltr.
inox mat, forme design, double paroi pour une meilleure conservation de la température, pour bouteilles de 0,5 à 1,5 l.

	Ø cm	↑ cm
36038	12,5 / 10	19



Flaschenkühler „ELEMENT“

bottle cooler
enfriador de botella
rafraîchisseur de bouteille

Beton, mit möbelschonender Unterseite
concrete, with non-scratching undersurface
el hormigón, con base antirradaduras
le béton, avec base revêtue antirayures



	Ø cm	↑ cm
36090	12 / 10	19



Flaschenkühler „CLASSIC“

bottle cooler
enfriador de botella
rafraîchisseur de bouteille

edler Kunststoffmantel in matt-metall Optik, Rand hochglanzpoliert, spezial isolierter Kunststoffeinsatz sorgt für beste Kühlung, für 0,5 - 1,5 Liter-Flaschen, Material: Mylar
noble plastic jacket in satin metal look, mirror polished finish edge, special insulated plastic insert, for 0,5 - 1,5 ltr. bottles, material: mylar
plástico imitación metal aspecto satinado, borde brillante, aislado interior especial para botellas de 0,5 a 1,5 ltr., material: mylar
plastique aspect métal satiné, bord brillant, paroi intérieure spécialement isolante pour bouteilles de 0,5 à 1,5 l., matière: mylar



	Ø cm	↑ cm
36036	12,5 / 10	22



Flaschenkühler

bottle cooler
enfriador de botella
rafraîchisseur de bouteille

Rand matt poliert, doppelwandig für beste Isolierung, für 0,7 - 1,5 Liter Flaschen
satin polished finish edge, double wall cooler keeps the temperature for a long time, for 0,7 - 1,5 ltr. bottles
borde pulido satinado, con doble pared para mantener más tiempo la temperatura para botellas de 0,7 a 1,5 l.
bord métallique mat, double paroi pour excellente conservation de la température, pour bouteilles de 0,7 à 1,5 l.



	Ø cm	↑ cm
36050	11,5 / 9,5	23



Flaschenkühler „ICE“

bottle cooler
enfriador de botella
rafraîchisseur de bouteille

transparent gefrostet, doppelwandig für beste Isolierung, ergonomische Rundung für eine bessere Handhabung, für 0,7 - 1,5 Liter Flaschen, Design patentiert
transparent frosted, double wall cooler keeps the temperature for a long time, ergonomic rounded for a better handling, for 0,7 - 1,5 ltr. bottles, design patented
transparente glaseado, la doble pared mantiene la temperatura durante mucho tiempo, diseño redondeado ergonómico para una mejor sujeción, plástico transparente satinado, para botellas de 0,7 - 1,5 diseño patentado
transparent satiné, design breveté ergonomique pour facile préhension, double paroi pour excellente conservation de la température, pour bouteilles de 0,7 à 1,5 l.

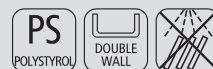

	Ø cm	↑ cm
36042	14 / 10	23,5



Flaschenkühler „CRYSTAL“

bottle cooler
enfriador de botella
rafraîchisseur de bouteille



doppelwandig für beste Isolierung, glasklar
doublewall, clear
doble pared
double paroi

	Ø cm	↑ cm
36062	13,5 / 10,5	23



1:1 Oberflächenansicht
1:1 structural view



Flaschenkühler „PURE“

bottle cooler
enfriador de botella
rafraîchisseur de bouteille



doppelwandig für beste Isolierung, glasklar
doublewall, clear
doble pared
double paroi

	Ø cm	↑ cm
36063	13,5 / 10,5	23



Flaschenkühler

bottle cooler
enfriador de botella
rafraîchisseur de bouteille



transparent, doppelwandig für beste Isolierung, mit Chromrand
transparent, double wall cooler keeps the temperature for a long time, with chrome edge
transpar., doble pared mantiene la temperatura por largo tiempo, borde superior cromado
transparent, bord chromé brillant, double paroi pour maintien en température

	Ø cm	↑ cm	Farbe / Colour
36032	12 / 10	23	
36034	12 / 10	23	



Kühlmanschette „WINE“

cool collar
funda enfriadora
manchette rafraîchissante



für Mineralwasser- und Weinflaschen, Aktivkühler, ohne Eis, nach 5 Minuten gekühlt, Aufbewahrung im Gefrierfach
for soda- and winebottles, active chiller without ice, chilled in 5 minutes, keep in the freezer
para botellas de agua embotellada y vino, enfría sin hielo, en sólo 5 minutos, guardar en el congelador
refroidit en 5 minutes, sans glace, conserver au congélateur, pour l'eau embouteillée et les bouteilles de vin

	cm	↑ cm	Farbe / Colour
36083	14 x 2	17,5	



Kühlmanschette

cool collar
funda de frío
housse isotherme



für Sekt- / Champagnerflaschen, einfach im Gefrierfach einfrieren, komplette Flasche wird in 5 Min. auf angenehme Trinktemperatur gekühlt, außen reißfestes Stoffgewebe, innen Kunststoff mit Kühlgel gefüllt, unbegrenzt wiederverwendbar

for bottles of champagne, simply to freeze in the freezer, complete bottles will be cooled down in only 5 minutes, tearproof cloth outside, plastic filled with gel inside, unlimited reusable

para botellas de cava o champán simplemente congelándola en el congelador, la botella entera se enfriará en 5 minutos, funda de plástico muy robusta, rellena con un gel congelante reutilizable ilimitadamente

pour bouteilles de vin ou champagne, la housse est préalablement stockée au congélateur, où elle accumule le froid, ensuite elle refroidit une bouteille en quelques minutes, plastique résistant, contient un liquide congelant, à réutiliser de façon illimitée

	Ø cm	↑ cm
36075	11	18



Weinflaschenhalter

winebottle-stand
soporte para botellas de vino
porte-bouteille



	cm	↑ cm
30333	22 x 6	20,5



Gläserchiene

glass rack
rack de copas
rack porte-verres



aus 6 mm verchromten Draht, Wand- und Deckenmontage möglich, bietet Platz für 20 Gläser
6 mm chrome plated wire, can be mounted under a shelf or on the wall, for 20 glasses
alambre cromado de 6 mm, puede instalarse bajo una estantería o en la pared para 20 copas
fil chromé de 6 mm, à installer sous une étagère ou contre un mur, pour 20 verres à pied

	cm	↑ cm
93400	45 x 32	6



Flaschenträger

bottle rack
porta botellas
porte-bouteilles



für 6 Flaschen, Ring Ø 9,5 cm
for 6 bottles, ring Ø 9,5 cm
para 6 botellas, Ø 9,5 cm
pour 6 bouteilles, Ø 9,5 cm

	cm	↑ cm
00630	32 x 21,5	32,5



Bierglasträger

beer rack
porta vasos de cerveza
porte verres à bière



für Glasgrößen 0,2 - 0,3 Liter, für 10 Gläser, Ring Ø 6,5 cm
for glasses size 0,2 - 0,3 liter, for 10 glasses, ring Ø 6,5 cm
para vasos tamaño 0,2-0,3 l, para vasos, Ø 6,5 cm
pour verres de 0,2 à 0,3 l, pour 10 verres, Ø 6,5 cm

	cm	↑ cm
00632	40 x 16,5	29

CONFERENCE



Flaschenkühler „CONFERENCE“

conference bottle cooler
enfriador múltiple
rafraîchisseur



inkl. Kühlakku, Flaschenöffner, Kronkorkenschale, mit 6 Öffnungen Ø 6,7 cm für 0,25 - 0,5 Liter-Flaschen

incl. bottle cooler, bottle opener, small cap bowl, with 6 holes Ø 6,7 cm for 0,25 to 0,5 liter bottles

con acumulador de frío, abridor, recuperador de chapas, 6 plazas Ø 6,7 cm, para botellas de 25 a 50 cl

avec accumulateur de froid, décapsuleur, bol récupérateur de capsules, 6 places Ø 6,7 cm, pour bouteilles de 25 à 50 cl

	Ø cm	↑ cm	Farbe / Colour
00620	23	15	White
00621	23	15	Black



Kühlakku

cooler
acumulador de frío
accumulateur de froid

	Ø cm	→ cm	Farbe / Colour
00616	7,5	11,5	White
00615	7,5	11,5	Black



Flaschenöffner

bottle opener
abridor
décapsuleur



	Ø cm	→ cm
00617	1	13,5



Kronkorkenschale

cap bowl
cuenco para chapas
bol récupérateur de capsules



	Ø cm	↑ cm	Farbe / Colour
00618	6,5	3	White
00619	6,5	3	Black

CRYSTAL



Trinkbecher „CRYSTAL“ drinking cups vasos gobelets



Kristallglas-Optik, vielseitig einsetzbar, robustes, unzerbrechliches Material, ideal in sensiblen Bereichen wie Pool, Spa, Beach und Wellness einzusetzen, BPA-frei
 crystal-glass-look, can be used in versatile ways, a solide and unbreakable material, ideal to be used in pool, spa, beach and wellness areas, bpa-free
 look de vidrio, se pueden utilizar de muchas maneras diferentes, material sólido e irrompible, ideal para el uso en áreas como piscina, spa, playa y bienestar, libre de BPA
 look de verre de cristal, peuvent être utilisés de différentes façons, matériau robuste et incassable, idéal pour une utilisation dans des zones comme la piscine, le spa, la plage et le bien-être, sans BPA

	Ø cm	↑ cm	ltr.	VE
10500	7	9,5	0,15	48
10501	8	12,5	0,30	48
10502	9	15,5	0,50	48



MOSCOW MULE

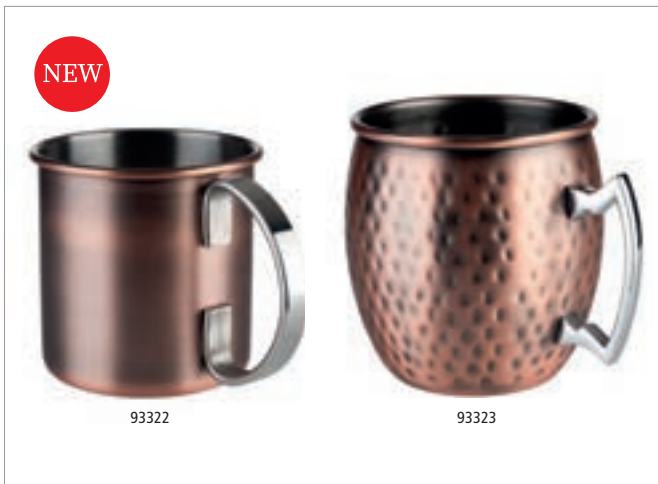

NEW

93322

93323

Becher „MOSCOW MULE“

barrel copper mug
taza
gobelet



Edelstahlbecher, Antik-Kupferlook, Chrom-Griff
stainless steel cup, copper look, chrome handle
taza de acero, por fuera encobrada, pomo acero
gobelet en acier, l'extérieur cuivré, poignée chromée

	Ø cm	↑ cm	ltr.	Farbe / Colour
93322	9	9	0,45	
93323	9	10	0,50	hammered



93310

93311

Becher „MOSCOW MULE“

barrel copper mug
taza
gobelet



Edelstahlbecher, Kupferlook, glänzend
stainless steel cup, copper look, highshine
taza de acero, por fuera encobrada, brillante
gobelet en acier, de l'extérieur cuivré, vergoldeter Griff

	Ø cm	↑ cm	ltr.	Farbe / Colour
93310	9	9	0,5	
93311	9	10	0,55	hammered

JULEP MUG

NEW



Becher „JULEP MUG“
barrel
taza
gobelet



	Ø cm	↑ cm	ltr.	Farbe / Colour
93327	8,5	10	0,35	 copper-antique



Becher „JULEP MUG“
barrel
taza
gobelet



	Ø cm	↑ cm	ltr.	Farbe / Colour
93328	8,5	10	0,35	



Becher „JULEP MUG“
barrel
taza
gobelet



	Ø cm	↑ cm	ltr.	Farbe / Colour
93329	8,5	10	0,35	

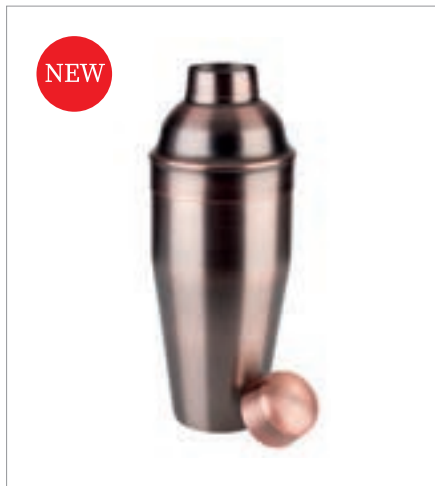

Shaker „CLASSIC“

shaker
coctelera
shaker

Edelstahlbecher, Antik-Kupferlook
stainless steel mug, copper antique look
taza de acero, por fuera encobrada
l'extérieur cuivré



	Ø cm	↑ cm	ltr.	Farbe / Colour	
93326	9,0	23	0,7		copper-antique



Shaker „CLASSIC“

shaker
coctelera
shaker

Edelstahlbecher, außen verkupfert
stainless steel, copper look
vaso coctelero
bol mélangeur



	Ø cm	↑ cm	ltr.	Farbe / Colour	
93211	8,5	20	0,5		copper
93212	9,0	23	0,7		copper



Shaker „CLASSIC“

shaker
coctelera
shaker

hochglanzpoliert
mirror polished finish
acabado pulido brillante
brillant



	Ø cm	↑ cm	ltr.
36010	8,5	20	0,5
36011	9,0	23	0,7



Parisian Shaker

shaker
coctelera
shaker

mattiert
satin polished finish
acabado efecto satinado
fini mat effet satin



	Ø cm	↑ cm	ltr.
93179	9,5	24	0,7



Boston Shaker

boston shaker
coctelera boston
shaker boston



2-teilig: Becher, 700 ml, gummiert, rutschfest + Glas, 400 ml
2 pcs. set: beaker, 700 ml, rubberrized, anti-slip + glass, 400 ml
conjunto de 2 piezas: vaso coctelero con goma exterior 700 ml + vaso de vidrio 400 ml
2 pièces: bol mélangeur inox extérieur plastifié couleur 700 ml + bol en verre 400 ml

	Ø cm	↑ cm	ltr.	Farbe / Colour
93136	9	30	0,7	
93137	9	30	0,7	
93139	9	30	0,7	

Ersatzglas / spare glass / vaso de recambio / verre de rechange

	Ø cm	↑ cm	ltr.
93138	8,5	14,5	0,4

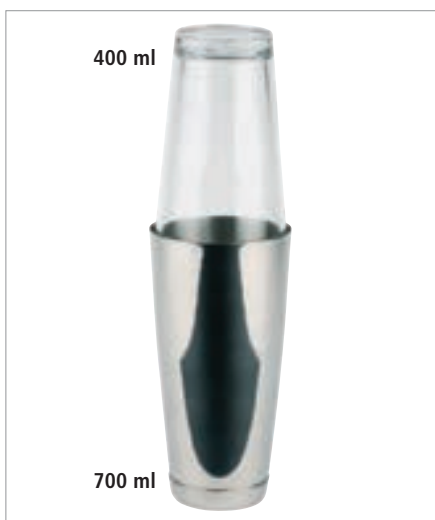

Boston Shaker

boston shaker
coctelera boston
shaker boston



2-teilig: Becher, hochglanzpoliert, 700 ml + Glas, 400 ml
2 pcs. set: beaker, mirror polished finish, 700 ml + glass, 400 ml
set de 2 piezas: vaso coctelero, pulido acabado brillante 700 ml + vaso vidrio 400 ml
2 pièces: bol mélangeur inox brillant 700 ml + bol en verre 400 ml

	Ø cm	↑ cm	ltr.
93140	9	30	0,70 / 0,40

Ersatzglas / spare glass / vaso de recambio / verre de rechange

	Ø cm	↑ cm	ltr.
93138	8,5	14,5	0,4

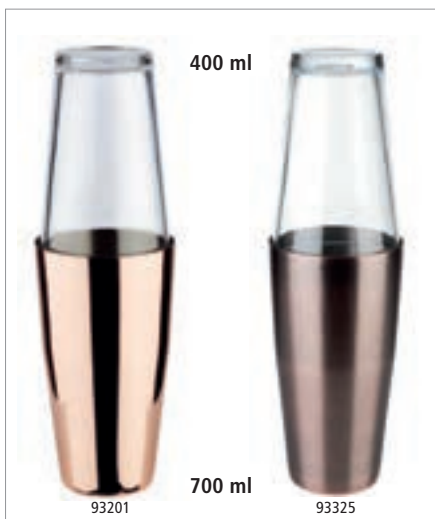

Boston Shaker

boston shaker
coctelera boston
shaker boston



2-teilig: Becher, hochglanzpoliert, 700 ml + Glas, 400 ml
2 pcs. set: beaker, mirror polished finish, 700 ml + glass, 400 ml
set de 2 piezas: vaso coctelero, pulido acabado brillante 700 ml + vaso vidrio 400 ml
2 pièces: bol mélangeur inox brillant 700 ml + bol en verre 400 ml

	Ø cm	↑ cm	ltr.	Farbe / Colour
93201	9	30	0,70 / 0,40	copper
93325 ^{NEW}	9	30	0,70 / 0,40	copper-antique

Ersatzglas / spare glass / vaso de recambio / verre de rechange

	Ø cm	↑ cm	ltr.
93138	8,5	14,5	0,4



Speed Shaker

boston shaker
coctelera boston
shaker boston



matt poliert, Größe oben Ø 8 cm, Größe unten Ø 6 cm
satin polished finish, size top Ø 8 cm, size bottom Ø 6 cm
pulido acabado satinado, arriba Ø 8 cm, medida abajo Ø 6 cm
poli mat satiné, Ø sup. 8 cm, Ø inf. 6 cm

	Ø cm	↑ cm	ltr.
36007	8	11,5	0,4



Eiseimer-Set mit Eiszange

ice bucket set with tong
cubitera isotérmica
seau à glaçons isothermique



Deckel hochglanzpoliert, Behälter matt poliert, inkl. Edelstahl-Eiszange
cover mirror polished finish, container satin polished finish, incl. stainless steel tong
tapa pulida efecto brillante, con doble pared, con pinza de hielo
couvercle brillant, double paroi, avec pince à glaçons

	Ø cm	↑ cm	ltr.
36013	12	14	1



Eiseimer-Set mit Eiszange

ice bucket set with tong
cubitera clásica con pinza
seau à glaçons classique avec pince



hochglanzpoliert, edler Kunststoffmantel, inkl. Edelstahl-Eiszange und Abtropfgitter mit Tragebügel, spezial isolierter Kunststoffeinsatz sorgt für beste Kühlung
mirror polished finish, noble plastic jacket, highly plated, incl. stainless steel tong and drainer, with handle, special insulated plastic insert for best cooling
exterior de plástico de alta calidad de aspecto metálico mate, incluye pinza de inox, plástico interior aislante especial
plastique aspect métal brillant, bonne qualité, avec pince inox et égouttoir, paroi intérieure spécialement isolante

	Ø cm	↑ cm	ltr.
36015	14	22	1,3



Eiseimer-Set mit Eiszange

ice bucket set with tong
cubitera clásica con pinza
seau à glaçons classique avec pince



edler Kunststoffmantel in matt-metall Optik, Rand hochglanzpoliert, Tragebügel transparent, spezial isolierter Kunststoffeinsatz sorgt für beste Kühlung, Kunststoffdeckel klar
noble plastic jacket in satin metal look, with mirror polished finish edge, handle transparent, special insulated plastic insert, transparent plastic cover
plástico aspecto metálico satinado, borde brillante, asa transparente, interior plástico aislante especial, tapa de plástico transparente
plastique aspect métal satiné, bord brillant, anse transparente, paroi intérieure spécialement isolante, couvercle transparent

	Ø cm	↑ cm	ltr.
36022	15	15	1,5
36024	20	18	3



Eiseimer-Set mit Eiszange

ice bucket set with tong
cubitera clásica con pinza
seau à glaçons classique avec pince



weißer Kunststoffmantel, Kunststoff-Tragebügel, spezial isolierter Kunststoffeinsatz sorgt für beste Kühlung, Kunststoffdeckel klar, inkl. Eiszange
white plastic jacket, plastic handle, special insulated plastic insert, for best cooling, transparent plastic cover, incl. tong
cubitera blanca, asa de plástico blanco, interior aislante especial con tapa transparente, con pinza
seau à glaçons, anse en plastique blanc, paroi intérieure spécialement isolante, couvercle transparent, avec pince

	Ø cm	↑ cm	ltr.
36027	15	15	1,5
36029	20	18	3



36037
8,0 Liter

Eisbox
ice box
cubitera
seau à glaçons



Aluminium eloxiert
aluminium anodised
aluminio anodizado
aluminium anodisé

	Ø cm	↑ cm	ltr.
36033	18,5	20	5
36037	27	20	8



Eisbox
icebox
cubitera
seau à glaçons



mit herausnehmbarem Tropfeinsatz
with drainer
plástico interior aislante especial
égouttoir

	cm	↑ cm	ltr.
93220	27 x 27	15	5,4



Eisbox
icebox
cubitera
seau à glaçons



mit herausnehmbarem Tropfeinsatz
with drainer
plástico interior aislante especial
égouttoir

	cm	↑ cm	ltr.
93200	20 x 20	17	3,4



Ø 5,5 cm

Eis-Kugel-Former
ice ball former
molde de cubitos de hielo esféricos
moule à glaçons en boules



2 tlg., 3 Kugeln à 100 ml, einfach mit Wasser füllen und gefrieren lassen
3 bowls à 100 ml, simply fill with water and allow to freeze
3 bolas de 100 ml, simplemente llenar con agua y dejar congelar
3 boules à 100 ml, simplement remplir avec de l'eau et mettre à congeler

	cm	↑ cm
12990	23,5 x 8,5	6,5



Eiszerkleinerer

Ice crusher
picadora de hielo
broyeur à glaçons



inkl. Behälter und Eisschaufel, mit Edelstahl-Messer, glänzend
with container and ice scoop, stainless cutters
con depósito y pala para el hielo, metal cromado
avec tiroir récupérateur et pelle, métal chromé

	cm	↑ cm
36009	16 x 13	27



Eiszerkleinerer

Ice crusher
picadora de hielo
broyeur à glaçons



glasklar, mit Edelstahl-Messer
clear, stainless steel cutters
cuchillas de acero inoxidable
couteaux inox

	cm	↑ cm
36017	12 x 12	24



Eiszange

ice tong
pinza para cubitos de hielo
pince à glaçons



matt poliert, mit griffigem Ende, ideal für Eiswürfel und Obstscheiben
satin polished finish, with handy end, ideal for ice cubes and fruit slices
pulido satinado, forma ergonómica ideal para cubitos de hielo y láminas de fruta
poli mat satiné, forme ergonomique idéale pour glaçons et fruits tranchés

	cm	→ cm
93190	2 x 1,5	20



Eiszange

ice cube tong
pinza para cubitos de hielo
pince à glaçons



hochglanzpoliert, fugenlos
mirror polished finish, seamless
pulido acabado brillante, de una sola pieza
brillant, d'une seule pièce

	cm	→ cm
75805	5 x 2	17,5



Eisschaufel
ice scoop
pala de hielo
pelle à glaçons



	cm	→ cm	ltr.
93192	10 x 6	29	0,7



Eisschaufel
ice scoop
pala de hielo
pelle à glaçons



gelocht, ideal zum Befüllen von schlanken Gläsern, Schmelzwasser fließt zurück in die Eisbox
perforated, ideal to fill narrow glasses, melt water flews back into the ice box
perforada, ideal para llenar vasos estrechos, el agua derretida cae en la caja de hielo
perforée, idéale pour verser les glaçons dans des verres étroits, l'eau retombe dans le bac à glaçons

	Ø cm	→ cm
93191	5	19



Eiszerkleinerer
ice crusher
pickadora de hielo
broyeur à glaçons



	Ø cm	→ cm
93193	2	19,5



Eiszerkleinerer
ice crusher
pickadora de hielo
broyeur à glaçons



	cm	→ cm
93194	6,5 x 2,0	23,0



Glasumrand
glass rimmer
ribeteador de vasos
bordeur à verres „rimmer“



Schwamm für Limettensaft, 2 Fächer für Zucker und Salz
with sponge for lime juice, 2 cases for sugar and salt
con esponja para zumo de lima, 2 compartimentos para azucar y sal
avec éponge et 2 compartiments pour sucre et sel

	cm	Farbe / Colour
93175	20 x 7,5	■



Stößel „BIG“

muddler
mortero
pilon muddler



POM mit Edelstahl-Kappe, flacher, glatter Stößel, zum Auspressen von Früchten und Zerstoßen von Würfelzucker

flat surface, to press fruits or pound lump sugar
superficie lisa para exprimir frutas y machacar azucarillos
muddler grand format avec bout lisse pour presser les fruits ou le sucre en morceaux

	Ø cm	→ cm	Farbe / Colour
93183	4,5	25	■



Stößel
muddler
mortero
pilon muddler



grober Stößel, zum Auspressen von Früchten und Zerstoßen von Würfelzucker

coarse notched, to press fruits or pound lump sugar
mortero grueso con muescas para exprimir frutas y machacar azucarillos
muddler grand format avec bout relief étoile pour presser les fruits ou le sucre en morceaux

	Ø cm	→ cm
93316	3,5	21,5



Stößel
muddler
mortero
pilon muddler



grober Stößel, zum Auspressen von Früchten und Zerstoßen von Würfelzucker

coarse notched, to press fruits or pound lump sugar
mortero grueso con muescas para exprimir frutas y machacar azucarillos
muddler grand format avec bout relief étoile pour presser les fruits ou le sucre en morceaux

	Ø cm	→ cm	Farbe / Colour
93182	4	24	■



Stößel
muddler
mortero
pilon muddler



mit griffigem Ende, zum Auspressen von Früchten und Zerstoßen von Würfelzucker

with handy end, to press fruits or pound lump sugar
acabado relieve para prensar frutas o azucar
avec relief grillagé pour presser les fruits ou le sucre en morceaux

	Ø cm	→ cm	Farbe / Colour
93180	2,5	21	■
93181	2,5	21	■





Barlöffel

bar spoon
cucharilla de cóctel
cuillère à cocktail

EDELSTAHL
STAINLESS
INOX



	→ cm	Farbe / Colour
93034	27	 copper

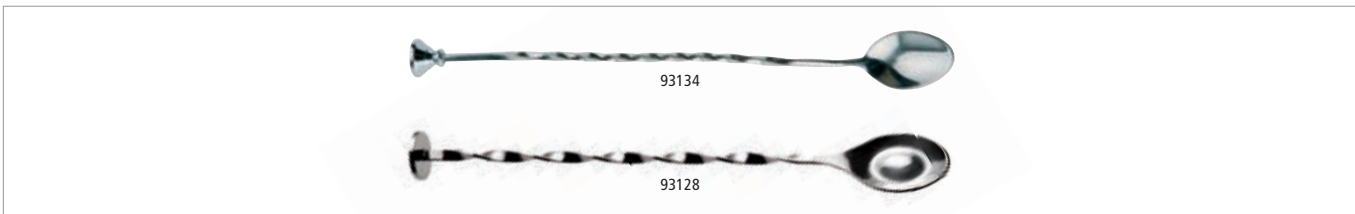

Barlöffel

bar spoon
cucharilla de cóctel
cuillère à cocktail

EDELSTAHL
STAINLESS
INOX



	→ cm
93134	27
93128	27

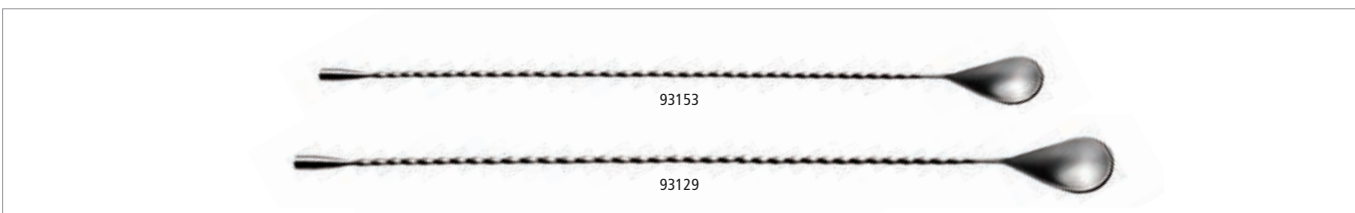

Barlöffel

bar spoon
cucharilla de cóctel
cuillère à cocktail

EDELSTAHL
STAINLESS
INOX



	→ cm
93153	40
93129	44

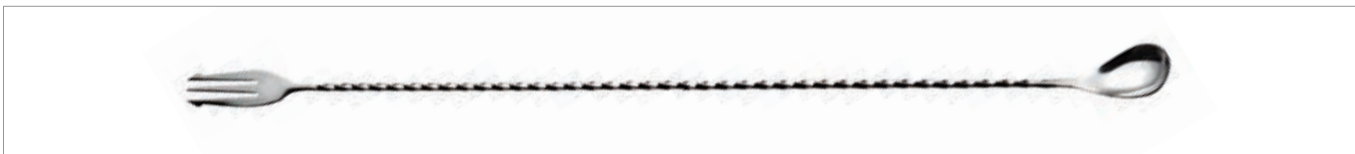

Barlöffel / - gabel

bar spoon
cucharilla de cóctel
cuillère à cocktail

EDELSTAHL
STAINLESS
INOX



	→ cm
93152	50



Barsieb

bar strainer
colador de cóctel
tamis cocktail



hochglanzpoliert, Spiralfeder hält Eiswürfel beim Abseihen zurück, Feder kann zur Reinigung entnommen werden, passend für alle Gläser und Shaker
mirror polished finish, coil spring keeps ice cubes in shaker, spring can be taken off for cleaning, suitable for all glasses and shakers
pulido acabado brillante, con muelle para mantener los cubitos en la coctelera, el muelle se desmonta para limpiar, se adapta a todos tipos de vasos y cocteleras
brillant, avec ressort pour garder les glaçons dans le shaker, ressort démontable pour lavage, s'adapte à tous types de verres mélangeurs et shakers

	Ø cm	→ cm
93312	9,5	18,0



Einhandgebrauch
handed use



Julep Barsieb „PRO“

julep strainer
colador de cóctel
tamis cocktail



hochglanzpoliert
mirror polished finish
acabado pulido brillante
fini poli brillant

	Ø cm	→ cm
93313	7,5	18,0



Einhandgebrauch
handed use



hot price

Barsieb

bar strainer
colador de cóctel
tamis cocktail



hochglanzpoliert, Spiralfeder hält Eiswürfel beim Abseihen zurück, Feder kann zur Reinigung entnommen werden, passend für alle Gläser und Shaker
mirror polished finish, coil spring keeps ice cubes in shaker, spring can be taken off for cleaning, suitable for all glasses and shakers
pulido acabado brillante, con muelle para mantener los cubitos en la coctelera, el muelle se desmonta para limpiar, se adapta a todos tipos de vasos y cocteleras
brillant, avec ressort pour garder les glaçons dans le shaker, ressort démontable pour lavage, s'adapte à tous types de verres mélangeurs et shakers

	Ø cm	→ cm
93300	11,0	15,0



Julep Barsieb „SIMPLE“

julep strainer
colador de cóctel
tamis cocktail



	Ø cm	→ cm
93305	8,0	15,5



Barsieb
bar strainer
colador de cóctel
tamis cocktail



	Ø cm	→ cm
93318	8,5	11,5



Cocktailmesser
bar knife
cuchillo para cóctel
couteau cocktail



mit 2 Zinken zum Aufspießen von Zitruscheiben
with 2 prongs to pick up slices of lemon
con 2 dientes para pinchar las rodajas de limón, etc.
avec 2 dents pour les rondelles de citron et autres décorations

	→ cm
88846	21



Schneidebrett „BAR“
cutting board
table de corte
planche à découper



HDPE, mit Safrinne, mit Antirutsch-Füßchen
HDPE, with juice groove and non-slip feet
HDPE, con ranura para líquidos y pies antideslizantes
HDPE, avec rigole et pieds antidérapants

	cm	↑ cm
93306	30 x 20	2
93307	50 x 30	2



Zitruspresse
citrus squeezer
exprimidor cítricos
presse-citron



hochglanzpoliert, 2-teilig
mirror polished finish, 2 pcs.
pulido brillante, 2 piezas
brillant, 2 pièces

	Ø cm	↑ cm	ltr.
71431	12 / 17	10,5	0,35

Bar & Café



2 Pressringe für Zitrone und Limette

Limetten- / Zitronenpresse

lime- / lemonpress
exprimidor de limón / lima
presse citron



	cm	↑ cm	Farbe / Colour
93214	21 x 7	5	



Limettenpresse

lime press
prensa de limón
presse citron



	cm	↑ cm	Farbe / Colour
93213	21 x 7	5	
93189	21 x 7	5	



Durch einfachen
Druck leichte
Teilung der
Zitrus!

Zitrusteiler

citrus wedger
cortador de cítricos
coupe-agrumes



mit Antirutsch-Füßchen, 2-teilig, Griffelement zur sicheren Bedienung mit innenliegendem Schneidmesser, teilt Zitrusfrüchte in Achtel, leicht unter fließendem Wasser zu reinigen
with non-slip feet, 2 pieces, handle for safe use and with internal cutting knife, cut citrus fruits in eight pieces, easy to clean with water
con pies antideslizantes, 2 piezas, asas para un uso seguro y con cuchillas internas, divide los cítricos en ocho partes, fácil de limpiar con agua
pieds antiglisses, 2 pièces, anses pour une usage sûr avec des lames internes, divise les agrumes en huit pièces, facile à nettoyer avec de l'eau

	cm	↑ cm
93317	20 x 15	19



Zitruspresse „PROFI“

juicer
 exprimidor cítricos
 presse citron



Zinkdruckguß verchromt, sehr stabile Ausführung, müheloses Entsaften durch Hebelmechanismus, extra Ausgießstille für tropffreies Pressen, Sieb fängt Kerne und Fruchtfleisch auf, möbelschonende GummifüÙe

zinc alloy chrome plated, stable and robust mechanism

fundición a base de aleación de zinc, cromado, alta calidad, reforzado y con mecanismo robusto y muy limpio, sin esfuerzo, pie revestido para no rallar la mesa de trabajo

fonte de zinc chromé, qualité renforcée, mécanique robuste et simple d'usage, sans effort

	cm	↑ cm
36014	26 x 20	max. 86



Zitruspresse

juicer
 exprimidor cítricos
 presse citron



Zinkdruckguß verchromt, mit Hebelmechanismus, äußerst standfest und robust, müheloses Entsaften durch Hebelmechanik, Sieb fängt Kerne und Fruchtfleisch auf, möbelschonende GummifüÙe

made from high quality steel, finished in chrome, stable and robust mechanism, non-scratching undersurface

super-profesional, fundición a base de aleación de zinc, cromado, alta calidad, reforzado y con mecanismo robusto y muy limpio, sin esfuerzo, pie revestido para no rallar la mesa de trabajo

super professionnel, fonte de zinc chromé, qualité renforcée, mécanique robuste et simple d'usage, sans effort

	cm	↑ cm
36019	19 x 18	max. 56

Bar & Café



Barmaß jigger medidor jigger measure double jigger



	Ø cm	↑ cm	cl	Farbe / Colour
93165	4	11	2,5 / 5	copper
93324 <small>NEW</small>	4	11	2,5 / 5	copper-antique



Barmaß Japanese jigger medidor measure double jigger



	Ø cm	↑ cm	cl	Farbe / Colour
93164	4	11	2,5 / 5	



Barmaß jigger medidor jigger measure double jigger



	Ø cm	↑ cm	cl
93121	4 / 3,5	8,5	2 / 4
93112	4,5 / 4	8,5	2,5 / 5



Barmaß jigger medidor jigger measure double jigger



	Ø cm	↑ cm	cl
93120	4,5 / 3,5	7,0	2 / 4



Barmaß jigger medidor jigger measure double jigger



hochglanzpoliert, schnelles und genaues Abmessen von Spirituosen
mirror polished finish, quick and exact measuring of spirits
rápida y exacta medición de licores y otros ingredientes
measure exacte et rapide pour alcool et autres ingrédients

	Ø cm	↑ cm	cl
93116	6 / 5	6	2 / 4



Trinkbecher „CRYSTAL“

drinking cups
vasos
gobelets



Kristallglas-Optik, vielseitig einsetzbar, robustes, unzerbrechliches Material, ideal in sensiblen Bereichen wie Pool, Spa, Beach und Wellness einzusetzen, BPA-frei
crystal-glass-look, can be used in versatile ways, a solide and unbreakable material, ideal to be used in pool, spa, beach and wellness areas, bpa-free
look de vidrio, se pueden utilizar de muchas maneras diferentes, material sólido e irrompible, ideal para el uso en áreas como piscina, spa, playa y bienestar, libre de BPA
look de verre de cristal, peuvent être utilisés de différentes façons, matériau robuste et incassable, idéal pour une utilisation dans des zones comme la piscine, le spa, la plage et le bien-être, sans BPA

	Ø cm	↑ cm	ltr.	VE
10500	7	9,5	0,15	48
10501	8	12,5	0,30	48
10502	9	15,5	0,50	48



Pitcher

pitcher
jarra
pichet



	Ø cm	↑ cm	ltr.
93105	13	21	1,5



Rührglas mit Lippe

mixing glass with lip
vaso mezclador vertedor con pico
verre mélangeur avec bec verseur



	Ø cm	↑ cm	ltr.
93141	9	16	0,5



1:1 Oberflächenansicht
1:1 structural view



Rührglas mit Lippe

mixing glass with lip
vaso mezclador vertedor con pico
verre mélangeur avec bec verseur



schwere Qualität
heavy quality
alta calidad
qualité renforcée

	Ø cm	↑ cm	ltr.
93101	11,5	19	1



Barmatte
drip mat
tapete escurridor
tapis de bar



aus weichem Kunststoff, zum Abtropfen von Gläsern etc.
soft plastic, to store and drain glasses
plástico blando para escurrir vasos
plastique souple, pour l'égouttage des verres

	cm	↑ cm	Farbe / Colour
93166	30 x 15	1	■
93167	45 x 31	1	■
93173	52 x 8	1	■
93168	60 x 8	1	■
93169	60 x 8	1	■



Abtropfmatte
drip mat
esterilla escurridora
tapis égouttoir



gerollt
rolled
enrollada
roulée

	cm	↑ cm	Farbe / Colour
93314	60 x 300	0,3	■
93315	60 x 300	0,3	■

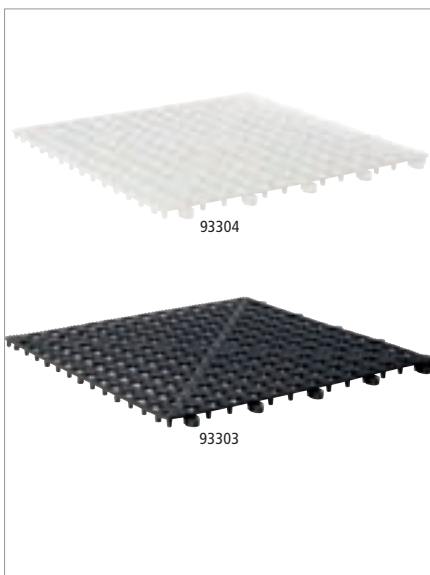

Abtropfmatte
drip mat
esterilla escurridora
tapis égouttoir



erweiterbar durch Klick-Verbindung
expandable
las placas de fijan con clips
avec clips de fixation

	cm	↑ cm	Farbe / Colour
93304	33 x 33	1,5	■
93303	33 x 33	1,5	■





Tropfenschale (2-tlg.)

drip tray
aros anti-goteo
anneaux coupe-gouttes



	Ø cm	↑ cm	Farbe / Colour
10851	9,5	1,5	White
10853	9,5	1,5	Black



Zutatenbehälter

condiment holder
dispensador de especias
boîte à fruits et ingrédients



500 ml Inhalt pro Fach, 6 Fächer, inkl. Deckel (gefroren) zur Lagerung
6 chambers à 50 ml, incl. lid for storing
6 compartimentos de 50 ml., incluye tapa para el almacenaje
6 compartiments de 50 ml chacun, avec couvercle pour le stockage

	cm	↑ cm	Farbe / Colour
93171	50 x 16	10	Black



Bar-Caddy

bar caddy
organizador de bar
organisateur „bar caddy“



Ordnungshilfe für Trinkhalme, Rührer, Servietten, Streichhölzer, etc.
to organize straws, stirrers, napkins, matches, etc.
para organizar pajitas, cucharillas, servilletas, cerillas, etc.
pour bien organiser les pailles, agitateurs, cuillers, serviettes et autres accessoires

	cm	↑ cm	Farbe / Colour
93174	24 x 15	11	Black



Bar-Set

bar set
conjunto de bar
set pour le bar



matt poliert, 5-teilig: Barsieb + Eiszange + Öffner + Messer + Ständer
satin polished finish, 5 pcs. set: strainer + ice tong + opener + knife + stand
acabado pulido satinado, 5 elementos: colador, pinza para hielo, abridor, cuchillo, soporte
fini mat satiné, 5 pièces: passoire à cocktail, pince à glace, décapsuleur, couteau, rack sup-
port

	cm	↑ cm
36012	13 x 7	20



Tablett

tray
bandeja
plateau



mit gebördeltem, polierten Rand
rolled and mirror polished edge
borde redondeado acabado efecto espejo
bord rond, effet miroir

	Ø cm	↑ cm
01336	35	3



Kellner-Flaschenöffner

waiter's barblade
abridor camarero
décapsuleur

matt poliert
satin polished finish
pulido acabado mate
poli mat



cm

93122 18 x 4



Kellner-Flaschenöffner

waiter's barblade
abridor camarero
décapsuleur

mit Gummierung
with rubber coating
con revestimiento de goma
avec revêtement en caoutchouc



cm

93125 11 x 4



Kronkorkenöffner

bottle cap opener
abridor de chapas de pared
décapsuleur mural

für die Wandmontage, aus massivem Metall
for wall fastening, massive metal
para fijación en la pared, metal macizo
massif, à fixer au mur



cm

↑ cm

93124 7 x 8 3



Kronkorken-Sammelbehälter

bottle cap holder
recogedor de chapas
bac récupérateur de capsules

matt poliert, für die Wandmontage unterhalb des Kronkorkenöffners
satin polished finish, for wall fastening beyond the opener
para fijar en la pared debajo del abridor, para recoger las chapas
à fixer au mur sous le décapsuleur mural



cm

↑ cm

93172 13,5 x 8 24

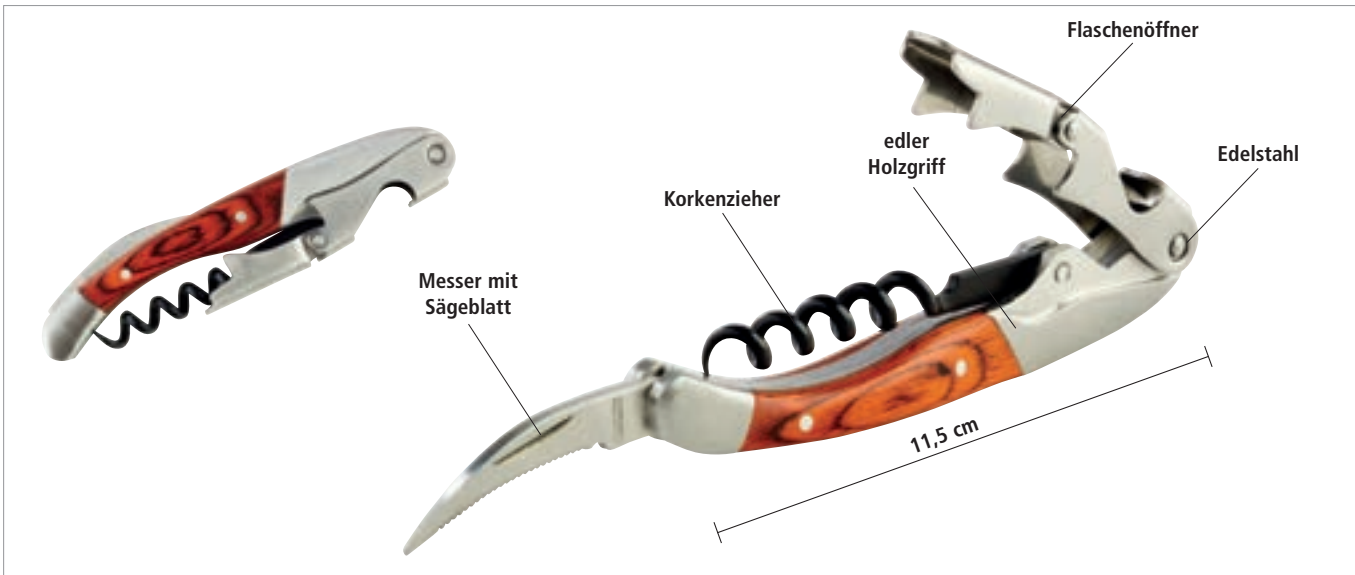

Kellnermesser „PROFI“

waiter's corkscrew
sacacorchos de camarero
tire-bouchons



leichtgängige Teflon-Spirale, mehrstufige Klapphebelfunktion, am Kopf angebrachtes Messer
easy moving teflon coil, 2-stage opening system, knife at the top end
mecha de teflón, sistema de apertura en 2 golpes, con cuchillo en la parte superior
mèche téflon, ouverture en 2 étapes, couteau dans la partie supérieure

→ cm
93302 11,5



Kellnermesser

waiter's corkscrew
sacacorchos de camarero
tire-bouchons



leichtgängige Teflon-Spirale, mehrstufige Klapphebelfunktion, am Kopf angebrachtes Messer
easy moving teflon coil, 2-stage opening system, knife at the top end
mecha de teflón, sistema de apertura en 2 golpes, con cuchilla en la parte superior
mèche téflon, ouverture en 2 étapes, couteau dans la partie supérieure

→ cm
93301 12



Korkenzieher

corkscrew
sacacorchos
tire-bouchons



durch die ausgefeilte Technik und den großen Holzhebel lässt sich eine Weinflasche mühelos mit zwei schnellen Bewegungen öffnen, schwere Profi-Qualität, Grifflänge 13,5 cm
a wine bottle can easily be opened with two quick actions due to the sophisticated technique and the large wooden lever, heavy professional quality, handle length 13,5 cm
para profesionales de la gastronomía y del vino, una botella se abre facilmente con sólo dos gestos, gracias a un eficaz mecanismo y a una palanca de 13,5 cm, alta calidad profesional
une bouteille s'ouvre simplement en 2 gestes avec son mécanisme sophistiqué et pratique, avec un levier de 13,5 cm, pour les professionnels de la gastronomie et du vin

→ cm
93299 53



Dosier- & Vorratsflasche

pouring container
botella „store & pour“
bouteille „store & pour“



4-teilig: Behälter + Flaschenhals + Schraubdeckel + Ausgießer Ø 11 mm mit Luftzufuhr für gezieltes Ausgießen, zum Dosieren und Aufbewahren

4 pcs. set: for storage, mixing and serving drinks, nozzle Ø 11 mm

set de 4 piezas: para almacenar y servir mezclas y bebidas, agujero de Ø 11 mm

se compose de 4 pièces: idéal pour servir et pour conserver les boissons, embout Ø 11 mm

	Ø cm	↑ cm	ltr.	Farbe / Colour
93144	9	33	0,85	
93145	9	33	0,85	
93146	9	33	0,85	
93147	9	33	0,85	
93148	9	33	0,85	
93149	9	33	0,85	



abnehmbarer Boden dient als Deckel
removable bottom serves as a lid



Dosier- & Vorratsflasche

pouring container
botella „store & pour“
bouteille „store & pour“



4-teilig: Behälter + Flaschenhals + Schraubdeckel + Ausgießer Ø 11 mm mit Luftzufuhr für gezieltes Ausgießen, zum Dosieren und Aufbewahren

4 pcs. set: for storage, mixing and serving drinks, nozzle Ø 11 mm

set de 4 piezas: para guardar, para mezclar y servir bebidas, boquilla Ø 11 mm

se compose de 4 pièces: idéal pour servir et pour conserver les boissons, embout Ø 11 mm

	Ø cm	↑ cm	ltr.	Farbe / Colour
93143	9	33	0,85	

abnehmbarer Boden dient als Deckel
removable bottom serves as a lid



Dosier- & Vorratsflasche

pouring container
botella „store & pour“
bouteille „store & pour“



4-teilig: Behälter + Flaschenhals + Schraubdeckel + Ausgießer mit Luftzufuhr für gezieltes Ausgießen, zum Dosieren und Aufbewahren

4 pcs. set: for storage, mixing and serving drinks

set de 4 piezas: para almacenar y servir mezclas y bebidas

se compose de 4 pièces: idéal pour servir et pour conserver les boissons

	Ø cm	↑ cm	ltr.	Farbe / Colour
94144	12,5	35	1,9	
94145	12,5	35	1,9	
94146	12,5	35	1,9	
94147	12,5	35	1,9	
94148	12,5	35	1,9	
94149	12,5	35	1,9	



abnehmbarer Boden dient als Deckel
removable bottom serves as a lid



Spritzflasche inklusive Ausgießer
 squeeze bottle with nozzle
 botella exprimible con dosificador
 flacon pulvérisateur avec bec verseur



ideal für Bitter-Liköre, Essig, Öl
 perfect for bitter liqueur, vinegar, oil
 perfecto para amargo licor, vinagre, aceite
 pour amaro liquore, vinaigre, huile

	cm	↑ cm	ltr.
93308	6 x 5	20	0,2

Ausgießer passend für Spritzflasche / nozzle suitable for squeeze bottle / dosificador apto para botella exprimible / bec verseur approprié pour flacon pulvérisateur

	Ø cm	↑ cm
93309	2,5	5,5

Abbildung in Originalgröße
 illustration original size

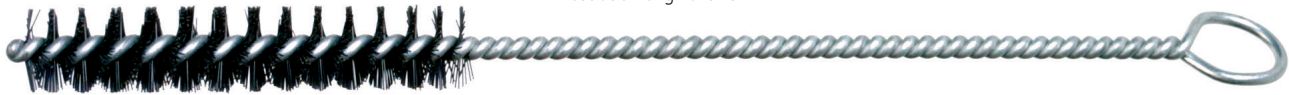

Reinigungsbürste für Ausgießer
 pourer cleaning brush
 cepillo de limpieza para picos vertedores
 brosse lave-bouchons doseurs



	→ cm
93102	16,5



Permanent-Ausgießer, 6er Set
 free flow pourer, 6 pcs. set
 vertedor continuos set 6 piezas
 set de 6 bouchons verseurs continus



à 2 Stück: blau, rot, gelb
 2 pcs of each colour: blue, red, yellow
 2 piezas de cada color: azul, rojo, amarillo
 2 par couleur: bleu, rouge, jaune

	Ø cm	↑ cm	pcs.
93111	3	7,5	6



Permanent-Ausgießer, 6er Set
free flow pourer, 6 pcs. set
vertedor contínuos set 6 piezas
set de 6 bouchons verseurs continus



	↑ cm	pcs.
93110	11	6
93320	11	6



Ausgießer, 2er Set
pourers, 2 pcs. set
vertedores set 2 piezas
set de 2 bouchons verseurs



Portionierer 2 cl, schnelles und genaues Abmessen
2 cl, quick and exact measuring
2 cl. medición rápida exacta
2 cl mesure exacte et rapide

	↑ cm	pcs.
93115	10	2



Permanent-Ausgießer, 6er Set
free flow pourer, 6 pcs. set
vertedor contínuos set 6 piezas
set de 6 bouchons verseurs continus



	↑ cm	pcs.
93114	8	6



Ausgießer „STEADY SPOUT“, 2er Set
pourers, 2pcs. set
vertedores set 2 piezas
set de 2 bouchons verseurs



Konstanter Durchfluss ohne Spritzer beim An- oder Absetzen durch patentierte Technologie, Ausgießer verfügt über unterschiedlich große Lamellen, die auf Flaschen mit einem Innendurchmesser von 18 bis 21,5 mm eingesetzt werden können. Nach Reinigung mit Warmwasser springt der Korken in die Ausgangsform zurück (Memory-Effekt).

Due to the patented technology you will have a constant flow and no splashing when turning and tipping the bottle, spout has different sizes of slats, which can be used on bottles with an internal diameter of 18 to 21,5 mm. After cleaning with hot water, the cork will return in its original shape (memory effect).

Gracias a la tecnología patentada el flujo es constante sin salpicar al servir, el surtidor ofrece listones de diferentes tamaños, que pueden ser utilizados en botellas con un diámetro interno de 18 a 21,5 mm. Después de la limpieza con agua caliente el corcho salta a su forma original (efecto memoria).

Grâce à la technologie brevetée le débit est constant sans éclaboussures lors du démarrage ou de l'arrêt, le bec offre lattes de tailles différentes, qui peuvent être utilisés sur les bouteilles d'un diamètre intérieur de 18 à 21,5 mm. Après avoir nettoyé à l'eau chaude, le bouchon en liège saute à sa forme originale (effet mémoire).

	↑ cm	pcs.
93319	10,5	2



Champagner-Verschluss

champagne saver
tapón vertedor
bouchon verseur



patentierter "Pull Down Bottle Grip", passt auf fast alle Standard Champagner- o. Sektflaschen
patented "Pull Down Bottle Grip", fits most champagne bottles
patentado, apto para la mayoría de botellas de cava o champagne
modèle déposé, apte pour la plupart de bouteilles de champagne

	cm	↑ cm
93135	5 x 5	8



Champagner- / Sektkonservator

champagne conservator
tapón conservador
bouchon de conservation



2-teilig: Überdruckpumpe + luftdichter Bügelverschluss mit Entlüftungsventil, Champagner und Sekt lassen sich nach dem Öffnen für längere Zeit frisch halten

2 pcs. set: overpressure pump + airtight swing-top with air valve, opened champagne and sparkling wine can be kept fresh for a longer time
set de 2 piezas: bomba a presión + tapón swing hermético con válvula de aire acero inox y plástico, el cava y las bebidas espumosas pueden conservarse y mantenerse por más tiempo.
set de 2 pièces: bombe à pression + bouchon swing hermétique avec valve - inox et plastique - enfin un moyen de conserver plus longtemps le champagne et autres vins mousseux

	Ø cm	↑ cm	Farbe / Colour
93126	4,5	12	■

Verschluss einzeln / stopper single / tapón individual / bouchon seul

93127



Sekt-Verschluss, 2er Set

stopper, 2 pcs. set
set de 2 tapones
set de 2 bouchons



matt poliert, innen Gummi Arabicum
satin polished finish, inside rubber arabicum, with inscription
acabado pulido mate, interior goma arábica con inscripción
poli mat satiné, intérieur gomme arabique

	Ø cm	↑ cm	pcs.
93160	4	5,5	2



Wein-Verschluss, 2er Set

wine stopper, 2 pcs. set
2 tapones para vino
2 bouchons pour le vin



matt poliert, innen Kunststoff, mit Schriftzug „WINE“
satin polished finish, inside plastic, with inscription „WINE“
acabado pulido mate, interior de plástico con inscripción „WINE“
poli mat satiné, intérieur plastique, avec inscription „WINE“

	Ø cm	↑ cm	pcs.
93206	4	4,5	2



Wein-Vakuumpumpe

vacuum wine pump
bomba de vacío para vino
pompe à vide pour le vin



inkl. 2 Stopfen, um offene Flaschen erneut zu versiegeln und den Wein zu konservieren
incl. 2 stoppers, to reseal open wine bottles and conserve the wine
incluye 2 tapones para cerrar perfectamente las botellas abiertas y conservar el vino
livrée avec 2 bouchons pour refermer les bouteilles tout en conservant le vin parfaitement

	Ø cm	↑ cm
93123	3,5	15

Weinpumpe-Ersatzstopfen, 2er Set / wine pump stopper, 2 pcs. set / tapones al vacío para el vino / set de 2 bouchons à vide pour le vin

	Ø cm	↑ cm	pcs.
93162	3	4,5	2

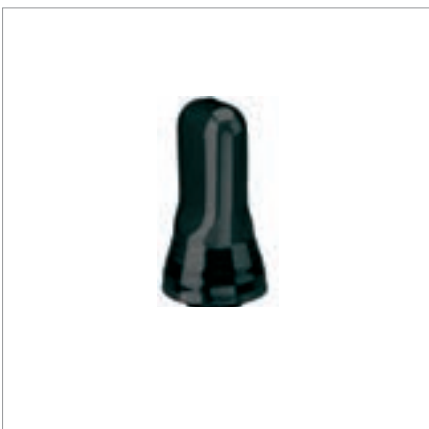

Staubkappen, 2er Set

dust & fly cap, 2 pcs. set
tapón antipolvo
bouchon anti-poussières et anti-insectes



schützt vor Staub und Insekten
protects for dust and insects
para proteger de la suciedad e insectos
pour protéger de la poussière et des insectes

	Ø cm	↑ cm	pcs.	Farbe / Colour
93161	4	8	2	■

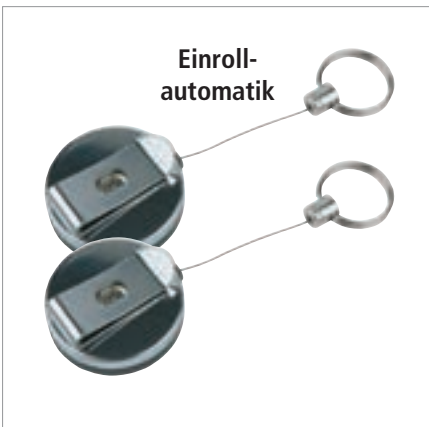

Einroll-
automatik

Schlüsselschnur, 2er Set

key cord, 2 pcs. set
llavero enrollable
porte-clés avec câble à enroulement



Schnur 65 cm lang, Befestigung mit Klammer am Gürtel, starke Rückzugfeder
65 cm long cord, to fix at waistbelt, strong pull-back spring
65 cm longitud del cable para fijar en una hebilla, cable enrollable automático con muelle
longueur 65 cm, à fixer à la ceinture, enroulage automatique

	Ø cm	↑ cm
93170	4	2



Gläserhalter / Tellerclips, 25er Set

glass plate clips, 25 pcs. set
25 pinzas sujeta copas
25 clips porte-verre



zum Feststecken von Sekt- oder Weingläsern am Tellerrand, ideal für Empfänge,
passend für alle gängigen Tellertypen und -größen, Größe innen Ø 3 cm
to clip on a plate and hold a glass, ideal for partys, useable for all current plates, size inside Ø 3 cm
pinzas de plato para sujetar la copa, ideal para fiestas, válido para cualquier plato corriente, plástico blanco, medida interior Ø 3 cm
pince porte-verre à pied, à fixer sur le bord d'une assiette, idéale pour réceptions, s'adapte sur tous types d'assiettes, plastique blanc, Ø int. 3 cm

	→ cm	pcs.
00111	8	25



Multistreuer
multi-functional shaker
salero
saupoudreuse



	Ø cm	↑ cm	ltr.
00774	7	12	0,20



geschlossen



Ø 2 mm



Ø 4 mm



Ø 6 mm



Multistreuer
multi-functional shaker
salero
saupoudreuse



	Ø cm	↑ cm	ltr.
00773	6	8	0,05



geschlossen



Ø 2 mm



Ø 4 mm



Ø 6 mm



Netzstreuer
mesh top shaker
polvoreador, tapa con malla fina
pot à épices, couvercle toile fine



	Ø cm	↑ cm	ltr.
00781	6,5	12	0,20



Multistreuer / Gewürzstreuer
multi-functional shaker
juego dosificador
jeu de salières



	Ø cm	↑ cm	ltr.
00782	6,5	12	0,20

00783	6,5	12	0,20	mit 8 Löchern / with 8 holes con 8 agujeros / avec 8 trous
-------	-----	----	------	---



00782



00783



300 ml

Allzweckgießer

pourer
bote vertedor universal
pot verseur universel



für Honig, Kaffeesahne, etc., Schraubdeckel aus Edelstahl
for honey, cream, etc., cover stainless steel
para miel, crema, etc., tapa inoxidable
pour le miel, le lait, la crème, etc., couvercle inox

	Ø cm	↑ cm	ltr.
00765	8,5	13,5	0,3

Ersatzglasbehälter / spare glas-container / contenedor de repuesto / récipient verre de rechange

00768



300 ml

Zuckerdosierer

sugar dispenser
azucarero
sucrier



Schraubdeckel aus Edelstahl
cover stainless steel
tapa inoxidable
couvercle inox

	Ø cm	↑ cm	ltr.
00766	8,5	15	0,3

Ersatzglasbehälter / spare glas-container / contenedor de repuesto / récipient verre de rechange

00768



40490
150 ml

40494
250 ml

Zuckerdosierer

sugar dispenser
azucarero
sucrier



Schraubdeckel aus Edelstahl, mit Dosierrohr
cover stainless steel with dosingtube
tapa inoxidable y tubo dosificador
couvercle inox et tube doseur

	Ø cm	↑ cm	ltr.
40490	8,5	12	0,15
40494	8	15	0,25

Ersatzglasbehälter / spare glas-container / contenedor de repuesto / récipient verre de rechange

	fits to
40498	40490
40499	40494



250 ml

Allzweckgießer

pouyer
dosificador
doseur



Schraubdeckel aus Edelstahl und Kunststoff, mit Dosierklappe

cover stainless steel and plastic, with dosing flap
acero inoxidable y tapa plástico, con cierre dosificador
couvrclé en inox et plastique, avec couvercle doseure

	Ø cm	↑ cm	ltr.
40488	8	12,5	0,25



250 ml

Zuckerdosierer

sugar dispenser
azucarero
sucrier



Schraubdeckel aus Edelstahl, mit Dosierrohr

cover stainless steel, with dosing tube
tapa inoxidable y tubo, con cierre dosificador
couvrclé inox et tube doseur

	Ø cm	↑ cm	ltr.
40486	8	15	0,25



320 ml

Zuckerdosierer

sugar dispenser
azucarero
sucrier



Schraubdeckel aus Edelstahl, mit Dosier-Rohr

cover stainless steel, with dosing tube
tapa inoxidable y tubo dosificador
couvrclé inoxydable et tube doseur

	Ø cm	↑ cm	ltr.
40506	7,5	17,0	0,32



320 ml

Zuckerdosierer

sugar dispenser
azucarero
sucrier



Schraubdeckel mit Klappe aus Edelstahl, mit Dosierklappe

cover stainless steel, with dosing flap
tapa acero inoxidable, con cierre dosificador
couvrclé inox, avec couvercle doseure

	Ø cm	↑ cm	ltr.
40487	7,5	13,5	0,32



200 ml

Zuckerdosierer

sugar dispenser
azucarero
sucrier



mit Schraubverschluss, Dosier-Rohr Ø 15 mm

cover and dosingtube Ø 15 mm
con tapa y tubo dosificador Ø 15 mm
couvercle avec tube doseur Ø 15 mm

	Ø cm	↑ cm	ltr.
40508	6,5	14,5	0,20



10316
170 ml

10317
170 ml

Zuckerspender / Milchkännchen

sugar pourer / milk jug
dispensador de azúcar
sucrier doseur



matt poliert

satin polished finish
pulido efecto satinado
intérieur et extérieur poli mat

	Ø cm	↑ cm	ltr.
10316	5	15	0,17
10317	5	11,5	0,17



Milch- / Zucker-Set

sugar-creamer-set
set para azúcar y leche
plateau avec sucrier et crémier



hochglanzpoliert, Sahnegießer, Zuckerdose, inkl. Löffel
mirror polished finish, milk jug, sugar bowl, incl. spoon
pulido brillante, con jarrita de leche, azucarero y cuchara
brillant, avec crémier, sucrier et cuillère

	cm	↑ cm
00635	15 x 11	6,5



Salz- und Pfefferstreuer, 2er Set

salt - and pepper shaker, 2 pcs. set
juego de 2 piezas de sal y pimienta
set de 2 sel et poivre



Edelstahl-Deckel
stainless steel cover
tapa acero inoxidable
couvercle inox

	Ø cm	↑ cm	pcs.
40507	6	10	2



Milchportionsspender

milk dispenser
dispensador de monodosas de leche
présentoir pour monodoses de lait ou crème



matt poliert, für ca. 36 Milchportionen, möbelschonende Unterseite
satin polished finish, for approx. 36 points, non-scratching undersurface
pulido efecto satinado, para aproximadamente 36 dosis, base antiralladuras
poli mat, pour environ 36 monodoses, base revêtue anti-rayures

	cm	↑ cm
00059	18 x 10	24



Portionsspender

dispenser
dispensador
présentoir



matt poliert, Spender für Milchportionen, Zuckertüten und Rührer, möbelschonende Unterseite
dispenser for condensed milk, sugar packs and stirrers
dispensador para leche condensada, sobres de azúcar, agitadores, base antiralladuras
idéal pour monodoses de crème ou lait, sucre en sachets longs, agitateurs, base revêtue anti-rayures

	Ø cm	↑ cm
00073	11	17,5



Zuckerkugel

sugar pot
azucarero
sucrier



hochglanzpoliert, mit Roldecke
mirror polished finish, rolltop cover
pulido acabado brillante, tapa abatible
brillant, couvercle abattant

	Ø cm	↑ cm
00033	13,5	15



Zuckertüten-Box

sugar pocket holder
azucarero para bolsitas
porte-sachetsw de sucre



matt poliert, für ca. 15 Zuckertüten
satin polished finish, for ca. 15 sugar packets
acabado pulido efecto satinado, capacidad 15 sobrecillos
poli mat, pour 15 sachets

	cm	↑ cm
11579	9 x 7,5	5



10320

Milchkännchen / Sahnegießer

milk / cream jug
jarra de leche/ crema
pichet à eau ou lait



	Ø cm	↑ cm	ltr.
10318	4	4	0,05
10319	4,8	5	0,09
10320	6	6	0,15



Milchkännchen, 4er Set

milk/cream jugs, 4 pcs. set
pack de 4 jarritas para leche o crema
pack de 4 crémiers



hochglanzpoliert, für Kaffeesahne, mit Griff, Inhalt à 25 ml
mirror polished finish, for coffee-cream, with handle, capacity à 25 ml
pulido brillante, para crema de café, con asa, capacidad 25 ml
brillant, avec anse, 25 ml

	Ø cm	↑ cm	pcs.	ltr.
10321	3,6	3,5	4	0,025



10334

Milch-/Universalkanne „ANTIHAFT“

non stick jug
jarra antiadherente
pichet antiadhésif



PTFE-antihafbeschichtet, perfekt für die Herstellung von Milchschaum
PTFE coated, for baristas frothing hot milk
revestimiento PTFE, ideal para espume de leche
revêtement PTFE, idéal pour faire mousser le lait

	Ø cm	↑ cm	ltr.
10334	8	10	0,35
10335	9	11,5	0,6
10336	10,5	13	0,8



10328

Milch- / Universalkanne

milk / water jug
jarra leche / agua
pichet à eau / lait



außen hochglanzpoliert, innen matt poliert
outside mirror polished finish, inside satin polished finish
exterior brillante, interior satinado
extérieur brillant, intérieur mat satiné

	Ø cm	↑ cm	ltr.
10328	8	10	0,35
10329	9	11,5	0,6
10330	10,5	13	0,8
10331	12	16,5	1,3
10332	13,5	18	2



10323

Kaffeekanne

coffee pot
cafetera
pichet à café



hochglanzpoliert, mit Klappdeckel
mirror polished finish, with hinged cover
acabado brillante, tapa con bisagra
poli brillant, couvercle à charnière

	Ø cm	↑ cm	ltr.
10323	8	11,5	0,35
10322	9	14	0,6
10325	10,5	15,5	0,9
10326	12	18,5	1,5
10327	13,5	20	2



Teebrühsieb

snap mesh tea ball
infusor de té, pinza con malla
boule à thé avec pince

matt poliert, mit feinem Sieb, aufklappbar
satin polished finish, with fine mesh, hinged
acabado pulido efecto satinado, con malla fina, con bisagra
inox mat, maille fine, avec charnière



	Ø cm	→ cm
74750	4,5	15,5



Zitronenschnitzelpresse

lemon slice squeezer
pinza exprimelimon
pince presse citron

hochglanzpoliert, zum Auspressen von Zitronenscheiben
mirror polished finish, to press lemon slices
pulido brillante, para rodajas de limón
brillant, pour citrons en rondelle



	cm
71430	8 x 7



für ca. 30 Teebeutel
for approx. 30 teabags

Schale, 3-geteilt

bowl, 3-section
cuenco, 3 secciones
bol 3 compartiments



	cm	↑ cm
83536	17,5 x 7,5	4,5



Behälter

container
recipiente organizador
récipient de table



	cm	↑ cm
83537	10 x 4	6,5



Schale, 2-geteilt

bowl, 2-section
cuenco, 2 secciones
bol 2 compartiments



	cm	↑ cm
83538	17,5 x 7,5	4,5



Serviertablett „KAFFEEHAUS“

tray
bandeja
plateau



	cm	↑ cm	Farbe / Colour
84250	26,0 x 20,0	1,5	■
84252	28,5 x 21,5	1,5	■
84251	26,0 x 20,0	1,5	■
84253	28,5 x 21,5	1,5	■



Serviertablett „KAFFEEHAUS“

tray
bandeja
plateau



Innenfläche ziseliert, Rand eingerollt
rolled edge
borde redondeado, superficie decor relieve
bord rond, surface entièrement ciselée

	cm	pcs.
30114	30 x 22	48



Serviertablett „KAFFEEHAUS“

tray
bandeja
plateau



matt poliert, Rand eingerollt
satin polished finish, rolled edge
acabado pulido satinado, borde redondeado
effet satin mat, bord rond

	cm	↑ cm
30119	23 x 23	1,5



Serviertablett „KAFFEEHAUS“

tray
bandeja
plateau



matt poliert, Rand eingerollt
satin polished finish, rolled edge
acabado pulido efecto satinado, borde redondeado
effet satin, bord rond

	cm	↑ cm
30118	21,5 x 13	1,5

mattiert
satin polished finish



30126



hochglanzpoliert
mirror polished finish

30136

Serviertablett „KAFFEEHAUS“

tray
bandeja
plateau



	cm	↑ cm	
30126	25,5 x 19,5	2	mattiert / satin polished finish acabado efecto satinado / fini mat effet satin
30127	30 x 23	2	mattiert / satin polished finish acabado efecto satinado / fini mat effet satin
30136	25,5 x 19,5	2	hochglanzpoliert / mirror polished finish acabado espejo pulido / poli brillant miroir
30137	30 x 23	2	hochglanzpoliert / mirror polished finish acabado espejo pulido / poli brillant miroir

Serviertablett „KAFFEEHAUS“

tray
bandeja
plateau



matt poliert, oval, Rand eingerollt
satin polished finish, oval, rolled edge
pulido acabado efecto satinado, oval, borde redondeado
effet satin, ovale, bord rond



30111

matt poliert
satin polished finish

	cm	↑ cm	
30111	19 x 15	1	für Zucker und Sahne / for sugar and cream para azúcar y crema / pour le sucre et la crème
30112	26,5 x 19	1	für eine Tasse / for one cup para una taza / pour une tasse
30113	29 x 22	1	für zwei Tassen / for two cups para dos tazas / pour deux tasses
30123	23 x 17,5	1	Eisdielen-Größe / icecream pralor size tamaño especial para heladerías / taille spéciale pour glaciers

Serviertablett „KAFFEEHAUS“

tray
bandeja
plateau



hochglanzpoliert, oval, Rand eingerollt
mirror polished finish, oval, rolled edge
pulido efecto espejo, ovalado, borde redondeado
effet brillant, ovale, bord rond



30116

hochglanzpoliert
mirror polished finish

	cm	↑ cm	
30115	19 x 15	1	für Zucker und Sahne / for sugar and cream para azúcar y crema / pour le sucre et la crème
30116	26,5 x 19	1	für eine Tasse / for one cup para una taza / pour une tasse
30117	29 x 22	1	für zwei Tassen / for two cups para dos tazas / pour deux tasses
30124	23 x 17,5	1	Eisdielen-Größe / icecream pralor size tamaño especial para heladerías / taille spéciale pour glaciers



Serviertablett „HAPPY HOUR“

tray
bandeja
plateau



rutschfeste Oberfläche
non-slip surface
superficie anti-deslizante
surface antidérapante

	Ø cm	↑ cm	Farbe / Colour
00510	32	1,5	■
00511	38	1,5	■
00515	43	1,5	■
.....			
	Ø cm	↑ cm	Farbe / Colour
00512	38	1,5	■
00513	38	1,5	■



Tablett „GASTRO“

tray
bandeja
plateau



rutschfeste Oberfläche
non-slip surface
superficie anti-deslizante
surface antidérapante

	Ø cm	↑ cm	Farbe / Colour
00547	27,5	2	■
00548	35,5	2	■
00549	40,5	2	■



Tablett „BISTRO“

tray
bandeja
plateau



rutschfest, mit 2 Griffmulden und Stapelrand
non-slip, two open handles, stackable edge
anti-deslizante, 2 asas
antidérapant, 2 anses

	Ø cm	↑ cm	Farbe / Colour
84045	35,5	4,5	■



Bierglasträger „RUTSCHFEST“

beer rack
bandeja para cerveza
porte verre à bière



rutschfeste Oberfläche
non-slip surface
superficie anti-deslizante
surface antidérapante

	Ø cm	↑ cm	Farbe / Colour	
00500	36	3,5	■	rund / round
00501	36	3,5	■	rund / round
.....				
	cm	↑ cm	Farbe / Colour	
00506	28 x 20	1,5	■	oval
00507	28 x 20	1,5	■	oval



Serviertablett „FLASH“

tray
bandeja
plateau



rutschfeste Oberfläche
non-slip surface
superficie antideslizante
surface antidérapante

	Ø cm	↑ cm	
00550	35,5	2	schwarz / weiß / black / white

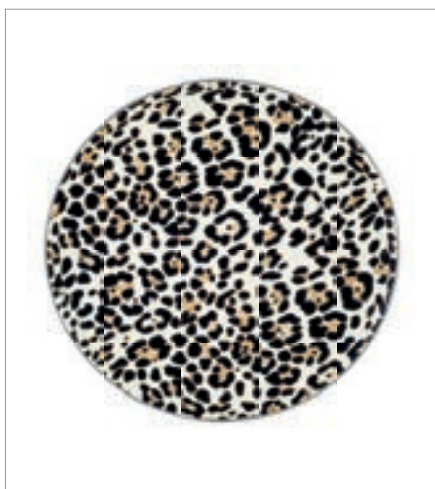

Serviertablett „COOL“

tray
bandeja
plateau



rutschfeste Oberfläche
non-slip surface
superficie antideslizante
surface antidérapante

	Ø cm	↑ cm	
00551	35,5	2	weiß / schwarz / braun / white / black / brown



Serviertablett „RUTSCHFEST“

tray non-slip
bandeja antideslizante
plateau antiglisse



rutschfeste Oberfläche
non-slip surface
superficie anti-deslizante
surface antidérapante

	cm	↑ cm	GN	Farbe / Colour
00502	53,0 x 32,5	1,5	1/1	
00508	46,0 x 36,0	2		
00505	53,0 x 32,5	1,5	1/1	
00503	53,0 x 37,0	1,5		



Tablett

tray
bandeja
plateau



rutschfest, Holzdekor-Laminat
non-slip, coated wood
antideslizante
antidérapant

	cm	↑ cm
00524	43,5 x 31,5	1,5
00525	52,0 x 39,0	1,5
00526	60,5 x 42,5	1,5



Fast Food-Tablett

snack tray
bandeja autoservicio y snacks
plateau self-service et snacks



	cm	↑ cm	GN	Farbe / Colour
00530	35 x 27	2		Red
00535	41 x 30,5	2		Red
00540	45 x 35,5	2		Red
00552	53,0 x 32,5	2	1/1	Red

	cm	↑ cm	GN	Farbe / Colour
00531	35 x 27	2		Black
00536	41 x 30,5	2		Black
00541	45 x 35,5	2		Black
00553	53,0 x 32,5	2	1/1	Black

	cm	↑ cm	GN	Farbe / Colour
00532	35 x 27	2		Brown
00537	41 x 30,5	2		Brown
00542	45 x 35,5	2		Brown
00554	53,0 x 32,5	2	1/1	Brown

	cm	↑ cm	GN	Farbe / Colour
00533	35 x 27	2		Light Grey
00538	41 x 30,5	2		Light Grey
00543	45 x 35,5	2		Light Grey
00555	53,0 x 32,5	2	1/1	Light Grey



Tablett

tray
bandeja
plateau



rutschfest, Mahagonifurnier
non-slip, woodform, mahogany
antideslizante
antidérapant

	Ø cm	↑ cm	
00528	31	3,5	hoher Rand
00529	35,5	3,5	hoher Rand
00527	32	1,5	flacher Rand



Tablett

tray
bandeja
plateau



rutschfest, Holzdekor-Laminat
non-slip, coated wood
antideslizante
antidérapant

	cm	↑ cm
00520	23,0 x 16,0	1,0
00521	26,0 x 20,0	1,0
00522	29,0 x 21,0	1,0
00523	38,0 x 27,0	1,5



Rechnungstablett, 2er Set

bill presenter, 2 pcs. set
 porta cuenta, set de 2 unidades
 porte-addition, set de 2 pièces



1 Edelstahl-Tablett hochglanzpoliert + 1 klappbare Ledermappe mit Stifflasche, mit Magnethalterung

1 stainless tray mirror polished finish + 1 leather presenter, with magnetic system
 1 bandeja de acero inoxidable pulido brillante + 1 presentador de cuero con sistema magnético
 1 plateau inox poli brillant + 1 pochette cuir aimantée

	cm	↑ cm
30109	20 x 16	2



Rechnungstablett

bill presenter
 porta cuenta
 porte-addition



mit Klemme für Rechnung

with clip for bill
 con clip para la nota
 avec clip pour la note

	cm	↑ cm
30108	20,0 x 12,0	0,5



Rechnungstablett

bill tray
 bandeja porta-cuenta
 plateau addition



mit Klemme für Rechnung

with clip for bill
 con clip para la nota
 avec pince

	cm	↑ cm
30110	17 x 11	1



35912

Rand eingerollt

Untersetzer

coaster
 posavasos
 plateau sous-verre



hochglanzpoliert, schwere Ausführung, Rand eingerollt
 mirror polished finish, heavy quality, rolled edge
 acabado pulido efecto espejo, alta calidad, borde redondeado
 effet miroir, bord rond, qualité extra

	Ø cm	pcs.
35711	10	6
35912	12	6



Windascher „DIAMOND“

ashtray
cenciero
cendrier



Metall verchromt, mit Bajonettverschluss
metal chrome plated, bayonet lock
metal cromado, opaco mate, cierre de bayoneta
métal chromé, mat, verrouillage par baïonnette

	Ø cm	↑ cm	Farbe / Colour	
00565	12,0	8,0		Glas gefrostet / glass frosted
00566	12,0	8,0		Glas glänzend / glass shiny
00567	12,0	8,0		Glas glänzend / glass shiny

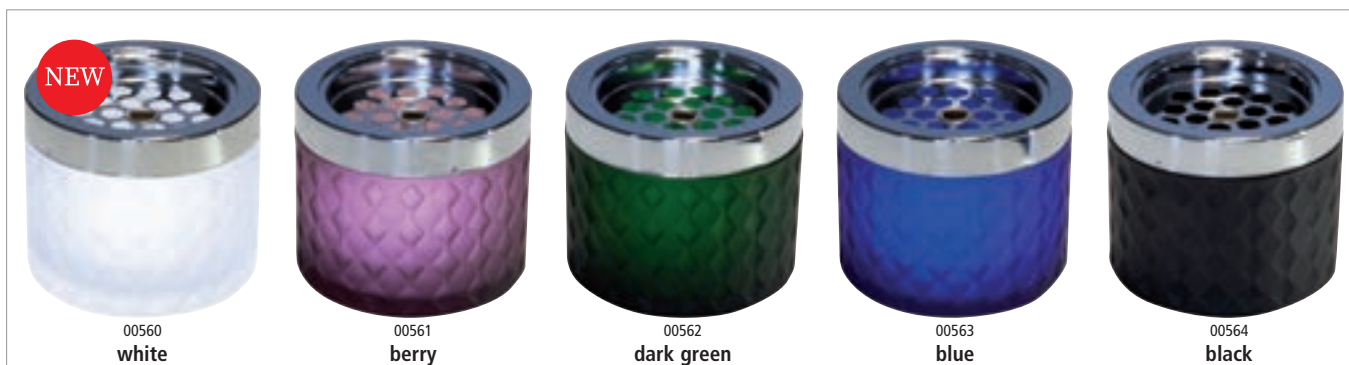

Windascher

ashtray
cenicero
cendrier



Metall verchromt, Glas gefrostet, mit Bajonettverschluss
metal chrome plated, glass frosted, bayonet lock
metal cromado, opaco mate, cierre de bayoneta
métal chromé, mat, verrouillage par baïonnette

	Ø cm	↑ cm	Farbe / Colour	
00560	9,5	8,0		
00561	9,5	8,0		
00562	9,5	8,0		
00563	9,5	8,0		
00564	9,5	8,0		

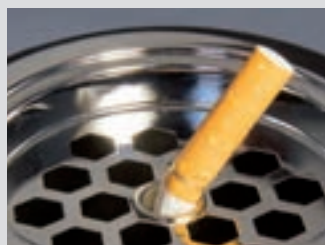



Windascher

ashtray
cenicero
cendrier



Metall verchromt, Glas gefrostet, mit Bajonettverschluss
metal chrome plated, glass frosted, bayonet lock
metal cromado, opaco mate, cierre de bayoneta
métal chromé, mat, verrouillage par baïonnette

	Ø cm	↑ cm	Farbe / Colour
00582	9,5	8	■
00583	9,5	8	■
00584	9,5	8	■
00585	9,5	8	■



Drehascher „KLASSIKER“

ashtray
cenicero
cendrier giratoire



Deckel mit Drehmechanismus
with rotary button
con botón giratorio
tourne par pression sur le bouton

	Ø cm	↑ cm	Farbe / Colour
00054	13	10,5	
00056	10,5	11	■



Drehmechanismus
rotary button



Aschenbecher

ashtray
cenicero
cendrier



Deckel hochglanzpoliert, Behälter matt poliert, mit Windschutzdeckel
lid mirror polished finish, container satin polished finish, with windcover
con tapa antiviento pulida brillante y contenedor pulido efecto satinado
couvercle anti-vent brillant, corps poli mat satiné

	Ø cm	↑ cm
00052	12	5,5



Aschenbecher

ashtray
cenicero
cendrier



matt poliert, mit Windschutzdeckel
satin polished finish, with windcover
acabado pulido satinado apilable, tapa para el viento
poli mat, empilable, couvercle anti-vent

	Ø cm	↑ cm
00090	10	4,5
00091	12	4,5



Aschenbecher

ashtray
cenicero
cendrier



matt poliert, hochwertige schwere Ausführung
satin polished finish, high quality, heavy gauge
pulido satinado, alta calidad, apilable
poli mat, empilable, belle qualité

	Ø cm	↑ cm
00048	8	3
00050	10	3



Wind-Aschenbecher „XL“

ashtray
cenicero
cendrier



	Ø cm	↑ cm	Farbe / Colour
84212	14,5	4,5	White
84213	14,5	4,5	Black



Wind-Aschenbecher

ashtray
cenicero
cendrier



	Ø cm	↑ cm	Farbe / Colour
83488	11,5	5	White
83489	11,5	5	Black



Wind-Aschenbecher

ashtray
cenicero
cendrier



	Ø cm	↑ cm	Farbe / Colour
83610	10	4	White
83612	12	4,5	White
83611	10	4	Black
83613	12	4,5	Black



Aschenbecher

ashtray
cenicero
cendrier



	Ø cm	↑ cm	Farbe / Colour
83614	9,5	4,5	White
83616	9,5	4,5	Black



Aschenbecher, 3er Set

ashtray, 3 pcs. set
set de cenicero 3 piezas
set de 3 mini cendriers



	Ø cm	↑ cm	pcs.	Farbe / Colour
00576	8	3	3	Black



Aschenbecher

ashtray
cenicero
cendrier



matt poliert
matt polished
pulido mate
poli mat

	Ø cm	↑ cm
00043	14	2,5
00044	16	2,5



Rezeptionsglocke

ring bell
timbre
sonnette



	Ø cm	↑ cm	Farbe / Colour
71400	8,5	6	Black
71433	10	6,5	Black



Standascher „DIABOLO“

standing ashtray
cenicero de pie
cendrier sur pied



für den Innen- und Außenbereich, inkl. 1,5 kg Sand, eine Ascheschale für die Sandbefüllung und ein Metallsieb
for in,- outdoor use, included a bag of sand and a metal sieve
uso en interior o exterior, incluye una bolsa de arena y embudo de metal
usage en intérieur ou extérieur, livré avec un sac de sable et entonnoir métal

	Ø cm	↑ cm
00574	40	60



vielseitig nutzbar
versatile



zerlegbar und stapelbar
dismountable and stackable

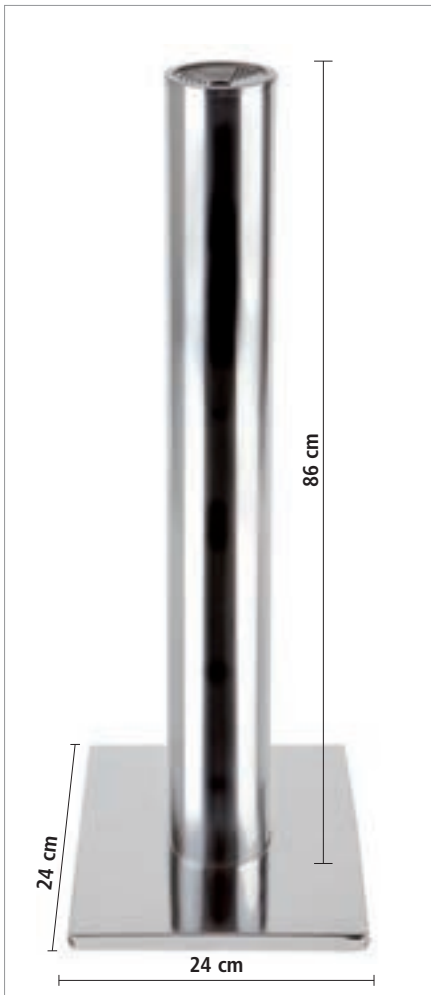

Standascher / Abfalleimer „SMOKERS POINT“

floor standing ashtray
cenicero de pie
cendrier sur pied



glanz poliert, mit herausnehmbaren Aschereinsatz
mirror polished finish, with ashtray insert and with litter bin
pulido acabado con cenicero y papelera
poli brillant inséré, extractible pour vidage facile

	Ø cm	↑ cm	ltr.
00579	9 / 24 x 24	86	3



3 Liter Einsatz
3 litre ashtray insert





Standascher / Abfalleimer

litter bin / ashtray
papelera con cenicero superior
poubelle avec cendrier supérieur



mit herausnehmbaren Aschereinsatz und herausnehmbaren verzinkten Innenbehälter / Eimer
with ashtray insert and litter bin
con cenicero y papelera metálica
cendrier et corbeille à détritus

	Ø cm	↑ cm
00575	30	60



Tretbeutelhalter

pedal bin
soporte a pedal
poubelle à pédale



geeignet für Müllbeutel bis 120 ltr., 110 x 70 cm
suitable for bags up to 120 ltr., 110 x 70 cm
apto para bolsas hasta 120 l., medidas sin bolsa 110 x 70 cm
apte pour sacs de 120 l., dim. sans sac 110 x 70 cm

	cm	↑ cm
00580	59 x 43	96



leichte Bedienung, Trittmechanismus
easy handling, step on bin

2 Lenkrollen mit Feststellern
2 wheels with brakes

Gummilippe 55 cm breit, Abstand zwischen Gummilippe und Bodenblech 82 cm





Servier- & Küchenhelfer

servicing items & kitchentools
herramientas de cocina
outils de cuisine

Kellen
Schnitzer
Wender
Zangen
Löffel

cucharones
talladores
espátulas
pinzas
cuchara

ladles
carver
turner
tongs
spoon

louches
bourdes
spatules
pincés
cuillère



Das Profimaterial Polyamid besteht aus Nylon und Fiberglas. Hitzebeständig bis 220°C, extra hochwertige Profi-Qualität, gut geeignet für antihafbeschichtete Pfannen, ergonomischer Griff.

Polyamide is made of nylon and fiberglass. Heat-resistant up to 220°C, extra high quality, perfect for non-stick-coated pots and pans, ergonomic handle.

Poliamide de nylon y fibra de vidrio. Brevemente al calor hasta 220°, calta calidad profesional, ideal para sartenes antiadherentes, mango ergonómico.

Polyamide de nylon et fibre de verre, haute résistance brièvement à la chaleur jusque 220°C, qualité professionnelle, idéal pour les poêles antiadhérentes, manche ergonomique.



Bratenwender

turner
espátula
spatule



	cm	→ cm
00603	11 x 9,5	35



Pfannenwender

turner
espátula
spatule



	cm	→ cm
00600	11,5 x 9,5	35



Pfannenwender

turner
espátula
spatule



	cm	→ cm
00604	15 x 7,5	30



Pfannenwender

turner
espátula
spatule



	cm	→ cm
88642	14 x 7	29



Pfannenwender

turner
espátula
spatule



	cm	→ cm
88640	13 x 6,5	29



Servierlöffel
serving spoon
cuchara de servicio
cuillère de service



	cm	→	cm	
88608	12 x 7		35	
00607	12 x 7		35	perforiert



Schaumlöffel
skimmer
espumadera
écumoire



	Ø cm	→	cm
00602	11,5		36,5



Schöpflöffel
ladle
cucharón
louche



	Ø cm	→	cm	ltr.
00606	9		32	0,1



Toastzange
sandwich tong
pinza para sandwich
pince à toasts



	cm	→	cm
00601	10 x 8		28



Spaghettizange
spoon
pinza espaguetis
pince universelle ou à spaghettis



	cm	→	cm
88637	9		24



Salatzange
salad tong
pinza ensalada
pince à salade



	cm	→	cm
00605	10 x 6		33



Pfannenwender

turner
espátula
spatule



	cm	→ cm
00645	9,0 x 8,5	21



Schaumlöffel

skimmer
espumadera
écumoire



	Ø cm	→ cm
00646	10,5	23



Servierlöffel

serving spoon
cuchara de servicio
cuillère de service



	cm	→ cm
00647	10 x 6	21



Schöpflöffel

ladle
cucharón
louche



	cm	→ cm
00648	9 x 8	23



Spaghettilöffel

spaghetti spoon
cuchara para espaguetis
cuillère à spaghettis



	cm	→ cm
00649	9 x 7	23

STOP-TOOLS

Die STOP-Funktion verhindert, dass Gabel oder Löffel in das Gefäß rutschen.

The smart STOP-function prevent forks and spoon not to slip into the vessel.

La función STOP evita que los cubiertos se caigan dentro del recipiente.
Antideslizante.

La fonction STOP empêche les couverts de glisser dans le récipient.



STOP Funktion



Servierlöffel geschlitzt

slotted spoon
cuchara de servicio
cuillère de service



Materialdicke 2,5 mm, ergonomischer, rutschfester Griff
ergonomic antislip handle
mango ergonómico antideslizante
manche ergonomique antidérapante

	cm	→ cm
00833	10 x 7,5	37,5



Servierlöffel

serving spoon
cuchara de servicio
cuillère de service



Materialdicke 2,5 mm, ergonomischer, rutschfester Griff
ergonomic antislip handle
mango ergonómico antideslizante
manche ergonomique antidérapante

	cm	→ cm
00834	10 x 7,5	37,5



Schöpflöffel

ladle
cucharón
louche



Materialdicke 2,5 mm, ergonomischer, rutschfester Griff
ergonomic antislip handle
mango ergonómico antideslizante
manche ergonomique antidérapante

	Ø cm	→ cm	ltr.
00832	9	35	0,08



Fleischgabel

meat fork
tenedor de carne
fourchette à viande



Materialdicke 2,5 mm, ergonomischer, rutschfester Griff
ergonomic antislip handle
mango ergonómico antideslizante
manche ergonomique antidérapante

	cm	→ cm
00831	10,5	38,5



Servierlöffel gelocht

serving spoon
cuchara de servicio
cuillère de service

ergonomischer, rutschfester Griff
ergonomic antislip handle
mango ergonómico antideslizante
manche ergonomique antidérapante



cm → cm
00664 10,5 x 7 34



Servierlöffel

serving spoon
cuchara de servicio
cuillère de service

ergonomischer, rutschfester Griff
ergonomic antislip handle
mango ergonómico antideslizante
manche ergonomique antidérapante



cm → cm
00662 10,5 x 7 34



Schöpflöffel

ladle
cucharón
louche

ergonomischer, rutschfester Griff
ergonomic antislip handle
mango ergonómico antideslizante
manche ergonomique antidérapante



cm → cm ltr.
00670 9 x 9 34 0,15



Bratenwender

slotted turner
espátula para plancha
spatule pour le grill

ergonomischer, rutschfester Griff
ergonomic antislip handle
mango ergonómico antideslizante
manche ergonomique antidérapante



cm → cm
00668 10 x 8 36

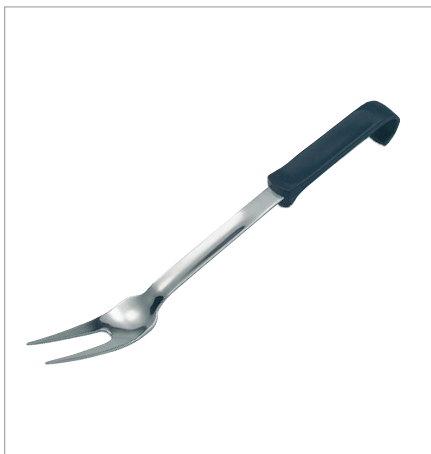

Fleischgabel

meat fork
tenedor de carne
fourchette à viande

ergonomischer, rutschfester Griff
ergonomic antislip handle
mango ergonómico antideslizante
manche ergonomique antidérapante



cm → cm
00666 7 / 10 34



Schöpföffel „PROFI“

ladle
cacillo
louche

EDELSTAHL
STAINLESS
INOX
18/8



	Ø cm	→ cm	litr.
00710	5	32,0	0,030
00711	6	34,0	0,050
00712	7	35,5	0,080
00713	8	38,0	0,125
00714	9	42,0	0,150
00715	10	43,5	0,250
00716	11	45,0	0,300
00717	14,5	48,0	0,550



Schaumlöffel „PROFI“

skimmer
espumadera
écumoire

EDELSTAHL
STAINLESS
INOX
18/8



	Ø cm	→ cm
00720	8	37,0
00721	10	40,5
00722	12	46,0
00723	14	50,5



Wender „PROFI“

turner
espátula
spatule

EDELSTAHL
STAINLESS
INOX
18/8



	cm	→ cm
00730	10 x 11,5	52



Servierlöffel „PROFI“

serving spoon
cuchara de servicio
cuillère de service

EDELSTAHL
STAINLESS
INOX



	cm	→ cm	
00671	10,5 x 7	41	geschlitzt / slotted / agujereada / ajourée
00672	10,5 x 7	41	



Spaghettilöffel „PROFI“

spaghetti spoon
cuchara de espaguetis
cuillère à spaghettis

EDELSTAHL
STAINLESS
INOX



	cm	→ cm
00673	11 x 6,5	39

BANQUET



Die Vorlegeserie BANQUET ist die passende Ergänzung zum Servieren am Buffet. Durch die mattierte Oberfläche und das gebogene Griffende wird BANQUET praktischen und optischen Ansprüchen gerecht.

The series BANQUET is the perfect addition for serving at the buffet. Due to the matt surface and the curved handle, BANQUET meets practical and optical requirements.

La serie BANQUET es la adición perfecta para servir en el bufé. Debido a la superficie mate y al mango curvado, BANQUET cumple con requisitos prácticos y ópticos.

La série BANQUET est l'ajout parfait pour servir au buffet. Grâce à la surface mate et la poignée incurvée, BANQUET répond aux exigences pratiques et optiques.



Salat- / Servierlöffel „BANQUET“

salad spoon / serving spoon
cuchara para ensalada / cuchara de servicio
cuillère à salade / cuillère de service



	cm	→ cm
00588	6,0 x 5	23,5
00590	7,5 x 6	29,0



Salatgabel „BANQUET“

salad fork
tenedor de servicio para ensalada
fourchette de service pour la salade



	cm	→ cm
00589	6,0 x 5	23,5
00591	7,5 x 6	29,0



Chafing Dish Löffel „BANQUET“

serving spoon
cuchara para servir
cuiller de service



	cm	→ cm	
00592	11 x 6,5	35	
00593	11 x 6,5	35	geschlitzt / slotted



Dressinglöffel „BANQUET“

dressing spoon
cuchara de aliño
cuillère à vinaigrette



	cm	→ cm
00594	6 x 4	34



Schöpföffel „BANQUET“

ladle
cucharón
louche



	cm	→ cm
00595	8,5 x 7,5	31



Fleischgabel „BANQUET“

meat fork
tenedor de carne
fourchette à viande



	→ cm
00596	21



Serviergabel „BANQUET“

fork
tenedor de servicio
fourchette de service



	→ cm
00597	31



Tortenheber „BANQUET“

cake lifter
pala de tartas
pelle à gâteau



eine Kante gezahnt
one edge serrated
un borde serrado
denté sur un côté

	cm	→ cm
00598	14 x 6	27



Servierlöffel „CLASSIC“

serving spoon
cuchara de servicio
cuillère de service



hochglanzpoliert, perforiert, Löcher Ø 4 mm, ergonomisch profilierter Hohl-Griff
mirror polished finish, perforated, holes Ø 4 mm, ergonomic designed handle
pulido brillante agujeros de Ø 4 mm, asa ergonómica
brillant, trous Ø 4 mm, manche ergonomique

	cm	→ cm
75903	9 x 6	32



Servierlöffel „CLASSIC“

serving spoon
cuchara de servicio
cuillère de service



hochglanzpoliert, ergonomisch profilierter Hohl-Griff
mirror polished finish, ergonomic designed handle
pulido brillante, asa ergonómica
brillant, manche ergonomique

	cm	→ cm
75904	9 x 6	32



Schaumlöffel „CLASSIC“

skimmer
espumadera
écumoire



hochglanzpoliert, ergonomisch profilierter Hohl-Griff
mirror polished finish, ergonomic designed handle
pulido acabado brillante, mango ergonómico
brillant, manche ergonomique

	Ø cm	→ cm
75911	11	36



Pfannenwender geschlitzt „CLASSIC“

turner
espátula ranurada
spatule rainurée



	cm	→ cm
75910	9 x 8	33



Tranchiergabel „CLASSIC“

fork
tenedor para carne
fouchette à viande



hochglanzpoliert, ergonomisch profilierter Hohl-Griff, Zinkenlänge 8 cm
mirror polished finish, ergonomic designed handle, length of prongs 8 cm
pulido brillante, asa ergonómica, largo de las puas 8 cm
brillant, manche ergonomique, dents long. 8 cm

	cm	→ cm
75905	8,5 x 2,5	32



Salatlöffel „CLASSIC“

salad spoon
cuchara para ensalade
cuillère à salade

hochglanzpoliert, ergonomisch profilierter Hohl-Griff
mirror polished finish, ergonomic designed handle
inox brillante, asa ergonómica
brillant, manche ergonomique



	cm	→ cm
75902	8 x 6	30



Salatgabel „CLASSIC“

salad fork
tenedor de servicio para ensalada
fourchette de service pour la salade

hochglanzpoliert, ergonomisch profilierter Hohl-Griff
mirror polished finish, ergonomic designed handle
pulido brillante, asa ergonómica
brillant, manche ergonomique



	cm	→ cm
75901	8 x 6	30



60 ml

Suppenkelle „CLASSIC“

soup ladle
cucharón de sopa
louche de service

hochglanzpoliert, ergonomisch profilierter Hohl-Griff
mirror polished finish, ergonomic designed handle
pulido brillante, asa ergonómica
brillant, manche ergonomique



	Ø cm	→ cm	ltr.
75907	7	28	0,06



100 ml

Suppenkelle „CLASSIC“

soup ladle
cucharón de sopa
louche de service

hochglanzpoliert, ergonomisch profilierter Hohl-Griff
mirror polished finish, ergonomic designed handle
pulido brillante, asa ergonómica
brillant, manche ergonomique



	Ø cm	→ cm	ltr.
75908	9	31	0,1

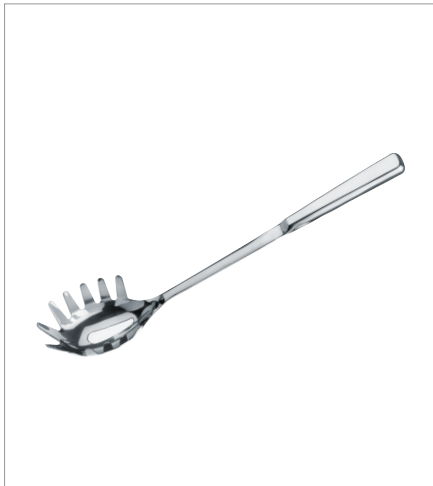

Spaghettiheber „CLASSIC“

spaghetti server
tenedor espaguetis
cuillère à spagettis



hochglanzpoliert, ergonomisch profilierter Hohl-Griff
mirror polished finish, ergonomic designed handle
acabado brillante, asa ergonómica
brillant, manche ergonomique

	cm	→ cm
75909	8 x 6,5	32,5



Saucengießlöffel „CLASSIC“

sauce / gravy ladle
cucharón de salsa
cuillère à sauce



hochglanzpoliert, ergonomisch profilierter Hohl-Griff, fugenlos
mirror polished finish, ergonomic designed handle, seamless
pulido brillante, asa ergonómica, sin soldadura
brillant, manche ergonomique, monobloc (sans soudure)

	cm	→ cm	ltr.
75906	7 x 5,5	28,5	0,02



Tortenmesser „CLASSIC“

cake slice
porcionador de pastel
couteau à tarte



eine Kante gezahnt 15,5 cm
one edge serrated 15,5 cm
un borde serrado de 15,5 cm
denté sur un côté à 15,5 cm

	cm	→ cm
75912	4,5 x 1	29



Tortenheber „CLASSIC“

cake lifter
pala de tartas
pelle à gâteau



hochglanzpoliert, mit einer gezahnten Kante, ergonomisch profilierter Hohl-Griff
mirror polished finish, one edge serrated, ergonomic designed handle
pulido brillante, canto dentado, mango ergonómico
brillant, bord microdenté, manche ergonomique

	cm	→ cm
75900	5 x 1	23



Salatzange

salad serving tong
pinza de ensalada
pinçe à servir la salade



hochglanzpoliert, einfache Handhabung
mirror polished finish, convenient handling
pulido brillante, manejo cómodo
brillant, manipulation aisée

	cm	→ cm
00685	7,0 x 4,5	25



Universalzange

multipurpose tong
pinzas multusos
pinçe multi-usages



hochglanzpoliert, einfache Handhabung
mirror polished finish, convenient handling
pulido brillante, manejo cómodo
brillant, manipulation aisée

	cm	→ cm
00688	7,0 x 4,5	25



Brot- und Gebäckzange

bread and pastry tong
pinza para pan y bollería
pinçe à pain ou viennoiseries



hochglanzpoliert, einfache Handhabung
mirror polished finish, convenient handling
pulido brillante, manejo cómodo
brillant, manipulation aisée

	cm	→ cm
00686	7,0 x 4,5	25



Brot- und Gebäckzange

bread and pastry tong
pinza para pan y bollería
pinçe à pain ou viennoiseries



hochglanzpoliert, einfache Handhabung
mirror polished finish, convenient handling
pulido brillante, manejo cómodo
brillant, manipulation aisée

	cm	→ cm
00687	7,0 x 4,5	25



Allzweckzange

multipurpose tong
pinza multi-usos
pince universelle multi-usages



hochglänzend, mit Feder und Verschlusschieber, dekorative Greiferform
high-gloss finish, with spring and retaining clip, decorative gripper form
pulido brillante, con muelle y cierre deslizable, gancho con forma decorativa
finition brillante, avec mécanisme de verrouillage, forme de pince décorative

	cm	→ cm
88643	4 x 3	24
88644	4 x 3	30
88645	4 x 3	40



Aufschnitt- / Allzweckzange

sausage tong
pinza salchichas
pince à saucisses



hochglanzpoliert, fugenlos
mirror polished finish, seamless
pulido brillante, sin soldadura
brillant, monobloc

	cm	→ cm
75806	3 x 2,5	16



Gebäckzange

pastry tong
pinza para pasteles
pince à gâteaux



hochglanzpoliert, fugenlos, extra schwere Qualität
mirror polished finish, seamless, extra heavy gauge
pulido brillante, sin soldadura, alta calidad, resistente
brillant, monobloc, qualité extra, robuste

	cm	→ cm
75807	8,5 x 4	27,5



Universalzange

general tong
pinza universal
pince universelle



hochglanzpoliert, einseitig geschlitzt
mirror polished finish, slotted on one side
acabado brillante, agujereada en un lado
brillant, perforée d'un seul côté

	cm	→ cm
75800	5 x 2	24



Salatzange

salad tong
pinza ensalada
pince à salade



hochglanzpoliert, beidseitig geschlitzt
mirror polished finish, slotted on both side
acabado brillante, agujereada en 2 lados
brillant, perforéedes 2 côtés

	cm	→ cm
75801	5 x 2	24



Spaghettizange

spaghetti tong
pinza espaguetis
pince à spaghettis



hochglanzpoliert, fugenlos
mirror polished finish, seamless
acabado brillante, sin soldaduras
brillant, monobloc

	cm	→ cm
75810	6 x 3	19



Pinzettzange

fine tong / tweezer
pinza de emplatar
pince à dresser



hochglanzpoliert, geriffelte Grifffläche, schwere Qualität
mirror polished finish, ribbed handle, heavy gauge
acabado brillante, mango cómodo ranurado, alta calidad
brillant, manche rainuré antiglisse, qualité extra

	cm	→ cm
75809	1,5 x 1	30



Pinzettzange

fine tong / tweezer
pinza de emplatar
pince à dresser



hochglanzpoliert, geriffelte Grifffläche, abgerundete Spitzen vorne, schwere Qualität
mirror polished finish, ribbed handle, rounded on the tops, heavy gauge
acabado brillante, mango cómodo ranurado, alta calidad, puntas redondeadas
brillant, manche rainuré antiglisse, qualité extra, pointes arrondies

	cm	→ cm
75808	1 x 1	14,5



Fischzange

fish tong
pinza de pescado
pince pour le poisson



hochglanzpoliert, längs perforiert
mirror polished finish, slotted
pulido brillante
brillant

	cm	→ cm
75802	10,5 x 3	24



Gebäckzange

pastry tong
pinza para pasteles
pinçe à gâteaux

hochglanzpoliert, perforiert
mirror polished finish, perforated
pulido brillante, perforado
brillant, perforée



	cm	→ cm
75804	6,5 x 3	19,5



Gebäck- / Tortenzange

pastry tong
pinza para pasteles
pinçe à gâteaux

hochglanzpoliert, fugenlos
mirror polished finish, seamless
acabado brillante, sin soldadura
brillant, monobloc



	cm	→ cm
75803	7 x 3,5	17,5



Grillzange

barbecue tong
pinza barbacoa
pinçe à barbecue

Edelstahl, mit schwarzem kunststoffummanteltem Griff
black rubber coated handle
asa revestida de goma negra
poignée revêtue de résine noire



	cm	→ cm
75817	8 x 3,5	30,5



Eis- / Mehrzweckschaufel

scoop
pala universal
pelle multi-usages

hochglanzpoliert, Hohlgriff, fugenlos verbunden mit Schaufel, extra schwere Qualität
mirror polished finish, hollow handle, seamless fixed, extra heavy gauge
brillante, mango hueco, sin soldadura con gancho, muy resistente
brillant, manche creux, monobloc, avec crochet, très robuste



	cm	→ cm	ltr.
71009	8,5 x 4,3	17,5	0,05
71010	9,5 x 5,9	21,5	0,07
71011	12 x 6	23	0,14
71012	14 x 7,5	23,5	0,24
71013	15,5 x 8,5	24,5	0,30
71014	18 x 10	29	0,36
71015	22 x 13	35	0,47



Eisportionierer

ice cream scoop
cuchara para helado
cuillère à glace



hochglanzpoliert, mit Edelstahlfeder (physikalisch bedingt nicht korrosionsbeständig)
mirror polished finish, spring steel, spring is not stainless
pulido brillante, muelle de acero especial, no resistente al óxido
poli brillant, ressort acier spécial, non résistant à l'oxydation

	cm	→ cm	ltr.
71006	23,3 x 6,5	23	1/12
71005	22,7 x 6	22	1/16
71004	22,5 x 6	22	1/20
71003	22 x 6	21,5	1/24
71002	21,5 x 6	21,5	1/30
71001	21,5 x 6	21	1/36



Messlöffelsatz

set measuring spoon
juego de cucharas medidoras
jeu de cuillère à mesure



Löffel hochglanzpoliert, Stiele matt poliert, Skalierung: 1 Essl., 1 Teel., 1/2 Teel., 1/4 Teel.
bowl mirror polished finish, handles satin polished finish, measures: table spoon, tea spoon,
1/2 tea spoon, 1/4 tea spoon
bol medidor brillante, mango mate medidas: 1 cuchara de sopa, 1 cuchara de té, 1/2 cuchara
de té, 1/4 cuchara de té
corps brillant, manche mat, mesures: 1 cuillerée à soupe, 1 cuillerée à thé, 1/2 cuillère à thé,
1/4 de cuillère à thé

	cm
75600	14 x 4,5



Eierschneider

egg cutter
corta huevos
coupe-oeufs



zum Längs- und Querteilen von hart gekochten Eiern
to cut hard-boiled eggs
corta a rodajas un huevo duro
en rondelles

	cm	↑ cm
88099	14,5 x 8	2,5



Hummerbrecher

lobster cracker
pinza bogavante
pince à homard



	cm
74201	14 x 5,5



Feinkost- / Olivenlöffel, 6er Set

delicatessen / olives spoon, 6 pcs. set
cuchara gourmet / para aceitunas, set de 6 unidades
cuillère gourmet / à olives, pack de 6



geloht
perforated
perforadas
perforées

	cm	→ cm	pcs.	Farbe / Colour
88598	6 x 9	27	6	■



Feinkostlöffel, 6er Set

delicatessen spoon, 6 pcs. set
cuchara gourmet, set de 6 unidades
cuillère gourmet, pack de 6



	Ø cm	→ cm	pcs.	Farbe / Colour
88626	6	23	6	■



Feinkostlöffel, 6er Set

delicatessen spoon, 6 pcs. set
cuchara gourmet, set de 6 unidades
cuillère gourmet, pack de 6



	Ø cm	→ cm	pcs.	Farbe / Colour
88627	6	23	6	■



Feinkostlöffel, 6er Set

delicatessen spoon, 6 pcs. set
cuchara gourmet, set de 6 unidades
cuillère gourmet, pack de 6



	Ø cm	→ cm	pcs.	Farbe / Colour
88628	6	23	6	■



Dressinglöffel

dressing spoon
cuchara de aliño
cuillère à sauce



aus Kunststoff
plastic
plástico
plastique

	Ø cm	→ cm	ltr.	Farbe / Colour
88636	6	34	0,05	■
88609	6	34	0,05	■



Schneebeesen
whisk
batidor
fouet professionnel



	Drähte / wires	Ø cm	→ cm
88710	8	2,3	55



Schneebeesen
whisk
batidor
fouet



	Drähte / wires	Ø cm	→ cm
00744	8	1,5	28
00745	8	1,5	33
00746	8	1,5	38
00747	8	1,5	43
00740	8	2,3	48



Kesselbesen XXL
large whisk
batidor gigante
fouet géant



	Drähte / wires	Ø cm	→ cm
88675	8	2,3	125

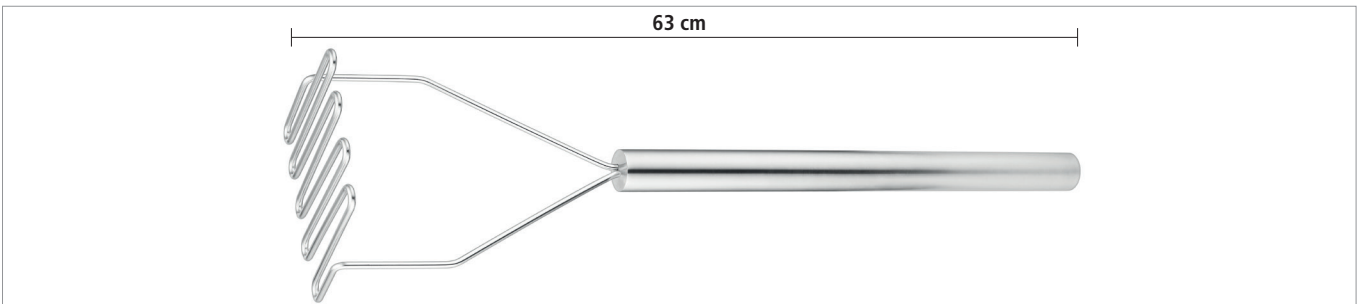

Kartoffelstampfer XXL
masher
machacador
pilon



	cm	↑ cm	Draht / wire Ø mm
88008	16 x 13	63	6



Spargelschäler „ORANGE“
 asparagus knife / asparagus peeler
 pelador de espárragos
 peleur à asperges



schält Spargel sparsam und gleichmäßig, mit Stellschraube für variable Schneiddicken
 peels asparagus curt and consistant, with adjustable screw to change the thickness of peeling
 pela los espárragos uniformemente, tornillo para regular el grosor del pelado
 pèle les asperges uniformément, avec vis de réglage pour l'épaisseur des pelures

	→ cm
88822	22



Kugelausstecher - doppelt „ORANGE“
 melon baller - double
 vaciador doble de bola
 moule à boule double



zum Formen von Kugeln aus Obst, Gemüse oder Butter, Edelstahl mit geschärften Rändern
 to form balls out of fruits, vegetables, butter, etc., stainless steel with sharpened edge
 para hacer bolas con frutas, verduras, mantequilla, etc. acero inoxidable con borde afilado
 pour faire des boules de fruits, légumes, beurre, etc. inox, bord affûté

	Ø cm	→ cm
88810	2,2 + 2,5	16,5
88811	2,2 + 3,0	17



Kugelausstecher „ORANGE“
 melon baller
 vaciador de melón redondo
 moule à boule ronde simple



zum Formen von Kugeln aus Obst, Gemüse oder Butter, Edelstahl mit geschärften Rändern
 to form balls out of fruits, vegetables, butter, etc., stainless steel with sharpened edge
 para hacer bolas con frutas, verduras, mantequilla, etc. acero inoxidable con borde afilado
 pour faire des boules de fruits, légumes, beurre, etc. inox, bord affûté

	Ø cm	→ cm
88814	3	16
88815	2,5	16
88816	2,2	15,5
88818	1,5	15
88819	1,0	14,5



Ziseliermesser „ORANGE“
 canele / decorating knife
 cuchillo de decoración cincelador
 couteau zesteur cannelé



zum Einritzen von Linien und Mustern in hartschaliges Obst und Gemüse, zum Schälen von Zitrusfrüchten, Edelstahl mit geschärften Rändern
 to score lines or design in hard fruits and vegetables, to peel citrus fruits, stainless steel with sharpened edge
 para esculpir líneas o hacer dibujos sobre frutas o verduras, bastante duras para pelar cítricos, acero inoxidable con borde afilado
 pour découper des lignes et motifs sur fruits et légumes à peau dure ou pour peler les zestes des citrons ou oranges, inox, bord affûté

	→ cm
88820	15



Fadenschneider / Zester „ORANGE“

decorator / zester
cuchillo de decoración cincelador
couteau zesteur



zum Abziehen von feinsten Schalenstreifen, ideal zum Dekorieren von Torten und Desserts
to peel off very fine stripes of paring, these stripes are ideal to decorate desserts, cakes, etc.
para pelar tiras muy finas, ideal para decorar postres, tartas, etc.
pour couper en lanières fines, idéal pour la décoration de gâteaux et desserts, etc.

	∅ cm	→ cm
88823	0,2 + 0,5	14,5
88824	0,2	15



Ziseliermesser „ORANGE“

canele / decorating knife
cuchillo de decoración cincelador acanalado
couteau zesteur cannelé



zum Einritzen von Linien und Mustern in hartschaliges Obst und Gemüse, Edelstahl mit geschärften Rändern
to score lines or design in hard fruits and vegetables, stainless steel with sharpened edge
para dibujar líneas en frutas o verduras de piel dura, acero inoxidable con borde afilado
pour découper des lignes et motifs sur fruits et légumes à peau dure ou pour peler les zestes des citrons ou oranges, inox, bord affûté

	→ cm
88826	15



Sparschäler „ORANGE“

peeler
pelador
peleur



für Links- und Rechtshänder geeignet, mit zwei starren Klingen aus extra geschärftem + gehärtetem Edelstahl
useable left- and right handed, with 2 inflexible blades made out off sharpened, extra hardened stainless steel
para diestros y zurdos, con 2 cuchillas rígidas inox afiladas y muy resistentes
pour gauchers ou droitiers, 2 lames rigides affûtées en inox extra-résistant

	→ cm
88827	17



Orangenschäler „ORANGE“

orange peeler
pelador de naranjas
peleur à oranges



zum Einritzen von Linien in hartschaligen Zitrusfrüchten, zum Schälen von Zitrusfrüchten, ohne das Fruchtfleisch zu verletzen, Edelstahl mit Ziselierhaken
to score lines and design hart fruits and vegetables, to peel fruits without bashing the pulp, stainless steel with hook
para dibujar líneas en frutas y verduras de piel dura para pelar cítricos sin dañar la pulpa, acero inoxidable con gancho
pour découper des lignes et motifs sur fruits et légumes à peau dure ou pour peler les citrons ou oranges sans endommager la pulpe, inox, bord affûté

	→ cm
88828	17,5



Pizzateigschneider „ORANGE“

pizza cutter
cortador de pizza
roulette à pizza

zum einfachen Zerteilen von Pizza
to cut pizza easily
para cortar pizza fácilmente
pour une coupe facile de la pizza



	Ø cm	→ cm
88829	6	18,5



Teigrad - gewellt „ORANGE“

pastry cutter - fluted wheel
cortador de pastelería- rueda dentada
roulette à pâte, cannelée

ideal zur Pasta-Herstellung, zum leichten Trennen von Teig
ideal for making pasta, to cut dough easily
ideal para la pasta
idéal pour les pâtes maison



	Ø cm	→ cm
88830	6	18,5



Pendelschäler „ORANGE“

swivel peeler
pelador lama pivotante
peleur lame pivotante

zum schnellen und sparsamen Schälen von Obst und Gemüse, mit beweglicher Klinge
to peel fruits and vegetables with flexible blade
para pelar frutas y verduras con hoja flexible
pour couper des fruits et légumes avec lame flexible



	→ cm
88834	17



Butterroller „ORANGE“

butter curler
rizador de mantequilla
coquilleur à beurre

zum Formen von dekorativen Butterflocken
to form decorative curls out of butter
para formar rizos decorativos con mantequilla
pour faire des rubans et coquilles de beurre



	→ cm
88831	19



Entstieler / Entkerner „ORANGE“

tomato corer
quita-rabillo de tomate
équeuteur à tomates



zum einfachen Entfernen des Tomatenstiels, aus Edelstahl mit gezackter Krone
to remove the peduncles from tomatoes in one movement, can be used to remove the pulp of the tomato
ideal para cortar el rabo de los tomates de 1 gesto, o para hacer bolas de pulpa de tomate, inox, dentado
pour ôter la queue de la tomate en 1 seul geste ou pour former des boules avec la pulpe, inox, dentelé

	cm	→ cm
88835	2 x 2	15



Apfelentkerner „ORANGE“

apple corer
descorazonador de manzana
vide-pomme



durch leichtes Drehen kann das Kerngehäuse von Äpfeln, Birnen und anderen Früchten sorgsam herausgeholt werden, Edelstahl mit geschärften Rändern
with a light turn cores of apples, pears and other fruits can be cut off easily, stainless steel with sharpened edge
para descorazonar muy fácilmente manzanas, peras y otras frutas
pour évider facilement les pommes, poires ou autres fruits

	Ø cm	→ cm
88836	2,2	21
88837	1,6	18,5



Austernöffner „ORANGE“

oyster knife
abre ostras
couteau à huîtres



zum einfachen Aufbrechen von Austern, mit Fingerschutz, Edelstahl mit geschärften Rändern
to open oysters easily, with guard, stainless steel with sharpened edge
para abrir ostras fácilmente con protección para los dedos, acero inoxidable con punta afilada
pour ouvrir facilement les huîtres avec protection pour les doigts, inox, pointe affûtée

	→ cm
88839	14,5



Austernmesser „ORANGE“

oyster knife
abre ostras
couteau à huîtres



Edelstahl-Klinge zum Einstechen in die Schale, mit Fingerschutz
to open oysters easily, with guard
para abrir ostras fácilmente con protección para los dedos
pour ouvrir facilement les huîtres avec protection pour les doigts

	→ cm
88840	15



Dekoriermesser „ORANGE“
decorating knife „cannelé“
cuchillo acanalador
couteau canneléur



gezahnte Klinge aus geschärftem Edelstahl
serrated sharpened blade, stainless steel
hoja de sierra afilada, acero inoxidable
lame inox microdentée

→ cm

88843 19



Grapefruitmesser „ORANGE“
grapefruit knife
cuchillo para pomelo
couteau à pamplemousse



zum Filetieren von Zitrusfrüchten, inkl. Ziselierhaken zum Einritzen der Schale,
Edelstahl mit beidseitigem Sägeschliff

to fillet citrus fruits incl. sharpened hook, to open the paring,
stainless steel serrated on both sides
para cortar la pulpa del pomelo, hoja curvada dentada por ambos lados para zurdos y diestros, final en punta para pinchar, inox
lame fine recourbée microdentée des 2 côtés pour droitiers/gauchers, coupe aisément la chair du fruit et la lame en pointe permet de la piquer, inox

→ cm

88841 21



Tourniermesser „ORANGE“
paring knife
cuchillo curvado
couteau d'office bec d'oiseau



Klinge in Schnabelform, Klinge passt sich Rundungen perfekt an
with curved blade, blade adaptes perfect to curves
con hoja curva, acero inoxidable, hoja perfecta para productos redondos
lame inox, idéale pour produits ronds

→ cm

88844 17,5



Gemüsemesser „ORANGE“
paring knife
cuchillo mondador
couteau d'office



zum schnellen Schälen von Gemüse
to cut vegetables and fruits quickly
para cortar frutas y verduras con rapidez, acero inoxidable
lame inox, idéale pour la coupe rapide de fruits et légumes

→ cm

88845 21



Julienneschneider „ORANGE“

julienne cutting knife
cuchillo para cortar juliana
couteau à julienne



zum Schneiden feiner Streifen aus Gemüse oder Obst

to cut fine stripes out off fruits and vegetables
para cortar a tiras finas las frutas y verduras, inox, hoja afilada
pour couper en fines lanières les fruits et légumes

→ cm

88848

18,5



Pendelschäler „ORANGE“

swivel peeler
pelador reversible
éplucheur droitier/gaucher



für Links- und Rechtshänder geeignet, mit 2 beweglichen Klingen

suitable for right and left handed, with 2 flexibles blades
apto para diestros y zurdos, con 2 hojas flexibles acero inoxidable
adapté pour droitiers ou gauchers, lame inox flexible

→ cm

88849

19



Pendelschäler „ORANGE“

swivel peeler
pelador reversible
éplucheur droitier/gaucher



für Links- und Rechtshänder, ideal für das Schälen von Tomaten, mit 2 beweglichen Klingen

suitable for right and left handed, ideal to peel tomatoes, with 2 flexibles blades
apto para diestros y zurdos, ideal para pelar tomates, con 2 hojas flexibles
pour gauchers ou droitiers, idéal pour peler les tomates, 2 lames flexibles

→ cm

88850

16,5



Cocktailmesser

bar knife
cuchillo para cóctel
couteau cocktail



mit 2 Zinken zum Aufspießen von Zitrusseiben

with 2 prongs to pick up slices of lemon
con 2 dientes para pinchar las rodajas de limón, etc.
avec 2 dents pour les rondelles de citron et autres décorations

→ cm

88846

21



Käsehobel „ORANGE“

cheese slicer
rebanador de queso
couteau tranche-fromage

zum Schneiden von dünnen Käsescheiben
to cut thin slices of cheese
para cortar lonchas finas de queso
pour couper de fines tranches de fromage



→ cm

88853 21,5



Fischentschupper / Fischschaber „ORANGE“

fish scaler
escamador
écailleur à poisson

zum einfachen Entfernen von Schuppen, ohne die Fischhaut einzureißen
to scale fish easily
para quitar las escamas con facilidad
pour ôter facilement les écailles



→ cm

88852 20



Apfel- / Zwiebelteiler

apple / onion divider
porcionador de manzana / -cebolla
coupe-pomme ou oignon en quartiers

stabile Profiausführung, Klingen aus gehärtetem, geschärften Klingenstahl, geeignet für Früchte max. Ø 10 cm

heavy gauge, extra sharpened steel blades, max. Ø 10 cm
aluminio fundido de alta calidad, cuchillas de acero afilado extra max. Ø 10 cm
fonte d'aluminium, qualité extra, lames inox affûtées, Ø 10 cm



cm ↑ cm

88854 11 x 17 4,5



NEW

Flambierbrenner

chefs blow torch
soplete de cocina para flambear
chalumeau de cuisine

mit handelsüblichem Feuerzeuggas auffüllbar, Flamme einstellbar bis ca. 1300° C, Brenndauer von min. 60 Minuten

to be filled with commercial lighter gas, flame adjustable up to approx. 1300° C, burning time of at least 60 minutes

rellenable con gas de mechero comercial, llama ajustable hasta 1300 ° C, tiempo de combustión de al menos 60 minutos

rempli avec gaz pour briquet commercial, flamme réglable jusqu'à 1300 ° C, temps de combustion d'au moins 60 minutes



Ø cm ↑ cm

77315 4,5 16,5



Streichpalette „BLUE“

spatula
espátula
spatule



flexible Edelstahl-Klinge, rutschfester Griff, hitzebeständig
flexible blade stainless steel, non-slip handle, heat-resistant
hoja flexible acero inoxidable mango polipropileno termoresistente anti-deslizante
lame inox flexible, manche antiglisse en polypropilène thermorésistant

	cm	→ cm
88920	35 x 5	48,5
88921	30,5 x 4,5	43,5
88922	25 x 4	38,0
88923	20 x 3	33,5



Winkelpalette „BLUE“

spatula
espátula
spatule



flexible Edelstahl-Klinge
flexible blade stainless steel
hoja flexible acero inoxidable
lame inox flexible

	cm	→ cm
88928	17 x 5	30



Gebäckpalette „BLUE“

pastry spatula
paleta pastelera
spatule pâtissière



flexible Edelstahl-Klinge
flexible blade stainless steel
hoja rígida acero inoxidable
lame inox rigide

	cm	→ cm
88932	17 x 7,5	29,5



Wender „BLUE“

turner
espátula
spatule



flexible Edelstahl-Klinge
flexible blade stainless steel
hoja flexible acero inoxidable
lame inox flexible

	cm	→ cm
88933	15 x 6	27,5



Winkelpalette „BLUE“

turner
espátula
spatule

flexible Edelstahl-Klinge
flexible blade stainless steel
hoja flexible acero inoxidable
lame inox flexible



	cm	→ cm
88935	34 x 5	47,5
88936	29 x 4,5	42,5
88937	24 x 4	36
88938	18,5 x 3	32



Wender „BLUE“

turner
espátula
spatule

flexible Edelstahl-Klinge
flexible blade stainless steel
hoja flexible de acero inoxidable
lame flexible inox



	cm	→ cm
88939	24 x 7,5	37,5



Wender „BLUE“

turner
espátula
spatule

perforiert, flexible Edelstahl-Klinge
perforated, flexible blade stainless steel
hoja flexible inox agujereada
lame ajourée inox flexible



	cm	→ cm
88940	24,5 x 7,5	37,5



Wender „BLUE“

turner
espátula para plancha
spatule

flexible Edelstahl-Klinge
flexible blade stainless steel
hoja flexible de acero inoxidable
lame flexible inox



	cm	→ cm
88941	20 x 7,5	33
88942	15 x 9	28



Spachtel / Schaber „BLUE“

scraper
espátula plancha
spatule coudée spéciale grill



starre Edelstahl-Klinge
rigid blade stainless steel
hoja rígida acero inoxidable
lame inox rigide

	cm	→ cm
88929	11 x 10	25



Wender „BLUE“

turner
espátula
spatule



geschlitzt, flexible Edelstahl-Klinge
slotted, flexible blade stainless steel
hoja flexible inox agujereada
lame ajourée inox flexible

	cm	→ cm
88944	17 x 8,5	30



Spachtel / Fettabstecher „BLUE“

scraper
espátula plancha
spatule coudée spéciale grill



starre Edelstahl-Klinge
rigid blade stainless steel
hoja rígida de acero inoxidable
lame rigide inox

	cm	→ cm
88946	17 x 10	30
88947	15 x 7,5	28



Aufstrichmesser „BLUE“

sandwich knife
cuchillo para untar
couteau à tartiner



flexible Edelstahl-Klinge
flexible blade stainless steel
hoja flexible de acero inoxidable
lame flexible inox

	cm	→ cm
88948	8,5 x 3	18,5



Teigschaber / Abstecher „BLUE“

dough scraper
corta pasta
coupe-pâte

starre Edelstahl-Klinge
rigid blade stainless steel
hoja rígida de acero inoxidable
lame rigide inox



cm

88930 15,5 x 8



Pizzaschneider „BLUE“

pizza cutter
cortador de pizza
coupe-pizza

ergonomischer Griff
ergonomic handle
mango ergonómico
manche ergonomique



Ø cm → cm

88949 10 20



Pizzaschneider „PRO“

pizza cutter
cortador de pizza
coupe-pizza

ergonomischer Griff
ergonomic handle
mango ergonómico
manche ergonomique



Ø cm → cm

88727 10 25



Wender „PRO“

turner
espátula
spatule

flexible Edelstahl-Klinge
flexible blade stainless steel
hoja inox flexible
lame inox flexible



cm → cm

88701 12 x 8,7 29



88617

Passiersieb

 strainer
colador
passoire

feines Siebgewebe mit ca. 6 Löchern pro 1 cm²

 fine mesh with 6 holes per 1 cm²
malla fina con 6 agujeros por 1 cm²
toile fine avec 6 trous pour 1 cm²

	Ø cm	↑ cm	Stiellänge → cm
88617	26	12	28
88618	30	17	28



74703

Passiersieb

 strainer
colador
passoire

feines Siebgewebe mit ca. 6 Löchern pro 1 cm²

 fine mesh with 6 holes per 1 cm²
malla fina con 6 agujeros por 1 cm²
toile fine avec 6 trous pour 1 cm²

	Ø cm	↑ cm	Stiellänge → cm
74700	14	5,0	16
74701	16	6,0	16
74702	18	7,5	16
74703	20	8,5	16
74705	24	11,0	17
74706	26	11,0	17



74721

Doppelnetz . double mesh
Passiersieb

 strainer
colador
passoire

mit Doppelnetz, Netz außen: ca. 2 Löcher pro 1 cm, Netz innen: ca.5 Löcher pro 1 cm
with double mesh, outer mesh about 2 holes per cm, inner mesh about 5 holes per cm
con malla doble, malla exterior aprox. 2 agujeros /cm, interior aprox. 5 agujeros /cm
avec double étamine, extérieure env. 2 trous/cm, intérieure environ 5 trous/cm

	Ø cm	↑ cm	Stiellänge → cm
74721	20	8	18
74722	24	10	28



Passiermühle

 moulin / sieve
molino de grosellas
presse-groseilles

Rolle Buchen-Holz versiegelt, ca. 10 Löcher pro 1 cm²

 wood-piece beech, 10 holes per 1 cm²
bola ovalada de haya, 10 agujeros por 1 cm²
boule ovale en hêtre, 10 trous pour 1 cm²

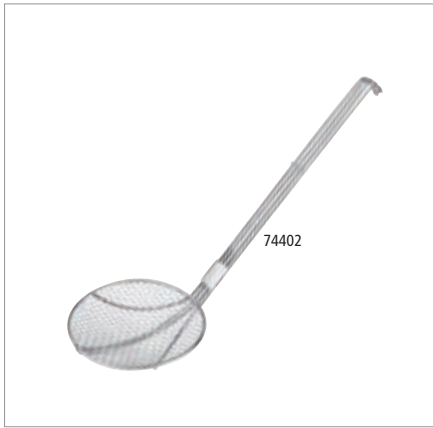
	Ø cm	↑ cm	Stiellänge → cm
88607	20	10	19



Back- / Frittierlöffel

skimmer / spider
espumadera para fritos
écumoire à friture

elektropoliert, sehr stabile Ausführung
electro polished, heavy gauge
electro pulido, alta calidad
poli électrolythique, qualité extra



	Ø cm	→ cm
74402	16	33,5
74403	18	33,5
74404	20	33,5



Back- / Pommes-Frites Schaufel

chips scoop
pala para patatas fritas
pelle à frites

mit geschlossenem Hohlgriff, schwere Qualität
closed hollow handle, heavy gauge
mango hueco cerrado alta calidad
manche creux fermé, qualité extra



	cm	→ cm
88601	21 x 18	15,5



Pommes-Frites Abfüll-Schaufel

chip bagger
recogedor para patatas fritas
pelle à frites

matt poliert, Stiel 14 cm
satin polished finish, handle 14 cm
pulido satinado con asa, mango de 14 cm
mat, avec anse, manche 14 cm



	cm	↑ cm
88019	23 x 21	5,5



Pommes-Frites-Seiher

fry dripping tray
escurridor de fritos
égouttoir à friture

herausnehmbarer Locheinsatz, mit Handgriff
removable drainer, with handle
fondo de colador desmontable, con asa
fond démontable, avec poignée



	Ø cm	↑ cm
00785	39	19



Salzstreuer

salt shaker
salero
salière

Pommes-Frites Streuer mit Schraubkappe
for french fries, cover to screw
para patatas fritas, tapa de rosca
pour les frites, couvercle à visser



	Ø cm	↑ cm	
00772	8	17	stainless steel
00779	8	17	aluminium

Gazespitzsieb

conical strainer with wire gauze
colador chino de malla
chinois renforcé avec maille fine



hochglanzpoliert, mit rundem Hohlgriff, ca. 9 Löcher pro 1 cm²
mirror polished finish, 9 holes per 1 cm²
pulido acabado brillante, mango hueco, 9 agujeros por 1 cm²
brillant, manche creux, 9 trous pour 1 cm²

	∅ cm	↑ cm	→ cm
88718	20	15	24
88717	24	19	24

Spitzsieb

conical strainer
colador cónico
chinois



mit Lochung ∅ 1,5 mm, auch in der Kegelspitze, mit Flachstiel, mit Stützstiel zum Einhängen in den Topfrand

with ∅ 1,5 mm holes (including the tip), with flat handle, with supporting hook
con agujeros finos de ∅ 1,5 mm (incluida la punta), con mango plano y gancho
perforations fines 1,5 y compris à la pointe, manche plat et crochet

	∅ cm	↑ cm	→ cm
00771	23	18	16,5

Likör- und Fondanttrichter

confectionery funnel
embudo dosificador
entonnoir à piston



ergonomischer Griff aus Kunststoff, mit 3 Düsen 2, 4, 6 mm, inkl. Ständer u. Auffangschale
ergonomic plastic handle, with 3 different nozzles 2, 4, 6 mm, incl. wire rack a. dripping dash
mango ergonómico con 3 boquillas, 2, 4, 6 mm, incl. pie de alambre y bandeja recoge gotas
manche plastique ergonomique, 3 douilles de 2, 4 et 6 mm, inclut pied avec ramasse-gouttes

	∅ cm	↑ cm	ltr.
77338	20	34	1,5

Gemüsehobel, Mandoline

mandolin
mandolina
mandoline



mit 7 verschiedenen Klingen (Breite 10 cm), Anti-Rutsch-Gestell, Schutzabdeckung

with 7 interchangeable blades (width 10 cm), non-slip folding stand, safety guard
con 7 cuchillas intercambiables (corte 10 cm), pie plegable anti-deslizante, carro de seguridad
7 peignes interchangeables (largeur 10 cm), pied repliable anti-glisse, chariot

	cm	↑ cm
88688	40,5 x 12	5 / 25



- A** 7 verschiedene Klingen
7 interchangeable blades
B Praktische Transportbox
Practical transport box



Wasserbadschüssel
 bain marie bailing bowl
 cazo para baño maría
 récipient bain-marie



hochglanzpoliert, mit Drahtgriff Ø 5 mm
 mirror polished finish, with wire handle Ø 5 mm
 inox pulido brillante, mango varilla Ø 5 mm
 inox brillant, manche fil épaisseur Ø 5 mm

	Ø cm	↑ cm	→ cm	ltr.
74731	18	9	15	1,5
74732	20	10	15	2.0
74733	24	12	15	3,5



Mess- / Universalkanne
 graduated jug
 jarra medidora universal
 pichet mesureur universel



matt poliert, mit Maßskalierung innen
 satin polished finish, with stamped liter scale inner
 acabado satinado, con graduación en el interior
 mat, graduations à l'intérieur

	Ø cm	↑ cm	ltr.
30054	12	13	1
30055	14	17	2



Messbecher
 graduated jug
 jarra graduada
 pichet gradué



außen hochglanzpoliert, innen matt poliert, mit Maßskalierung außen
 outside mirror polished finish, inside satin polished finish, with stamped liter scale
 exterior pulido brillante, interior satinado con escalado en litros
 extérieur brillant, intérieur satiné, graduation en litres

	Ø cm	↑ cm	ltr.
30044	8	11,5	0,5
30045	10	14	1



Messbecher
 measuring cup
 jarra graduada
 pichet gradué



mit geschlossenem Griff, mit geprägter Maßskalierung außen, l- und ml-Liter-Einteilung
 with handle, with stamped printed liter and ml scale
 con asa, graduación ml.
 avec anse, graduation en ml.

	Ø cm	↑ cm	ltr.
30046	9,5	14	0,5
30047	12	17	1
30048	15,5	21	2
30049	17,5	23,5	3
30057	20,5	27,5	5



Pastetenform mit Deckel
pastry mould with lid
molde para paté con tapa
moule à terrine avec couvercle

für Pasteten und Terrinen
for pasties and terrines
para patés y tarrinas
pour pâtés et terrines

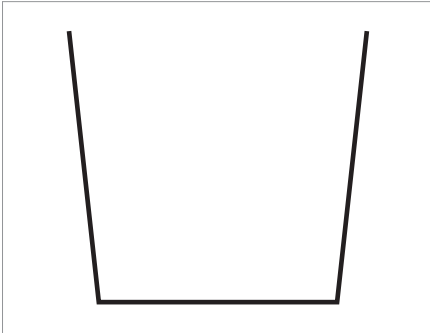

Pastetenform
terrine mould
molde tarrina ángulos rectos
moule à terrine évasé



	cm	→ cm	ltr.
88122	7 x 8	30	1,6

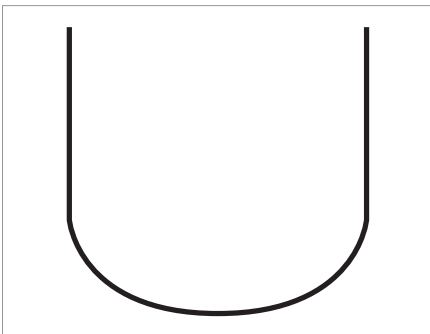

Pastetenform
terrine mould
molde tarrina redonda
moule à terrine arrondi



	cm	→ cm	ltr.
88123	5,5 x 5	27,5	0,5

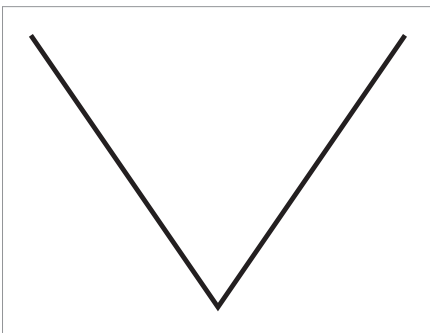

Pastetenform
terrine mould
molde tarrina triangular
moule à terrine triangulaire



	cm	→ cm	ltr.
88133	8 x 7,5	26	0,7

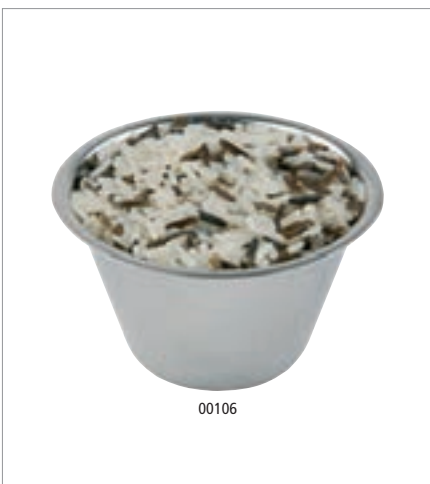

Dariolformen, 2er Set
dariol moulds, 2 pcs. set
juego 2 flaneras
jeu de 2 moules à flan

hochglanzpoliert
mirror polished finish
acabado brillante
brillant



	Ø cm	↑ cm	ltr.
00105	5,6	4,7	0,075
00106	6,3	4,5	0,1
00107	7,0	3,5	0,1
00108	8,5	5,0	0,2



Schaumspeiseringe, 5er Set

mousse ring, 5 pcs. set
juego aros para emplatar o para semifríos
jeu de cercles à mousse inox, ronds



5-teilig: 4 Formen + 1 Verdichter, matt poliert, fugenlos

5 pcs. set: 4 shapes and 1 pusher, satin polished finish, seamless
juego de 5 piezas: 4 aros redondos y 1 pulsador, para dar forma, satinado sin soldadura
jeu de 5 pièces: 4 cercles et 1 poussoir. Idéal pour dressage sur assiette ou mousse, mat satiné, sans soudure

	Ø cm	↑ cm
00110	6	4,5
00113	8	4,5
00114	10	4,5



Schaumspeisering

mousse ring
aro redondo para semifríos
cercle à mousse rond



matt poliert, fugenlos

satin polished finish, seamless
acabado satinado sin soldadura
mat satiné, sans soudure

	Ø cm	↑ cm
00098	6	4,5
00099	7	4,5
00092	8	4,5
00093	10	4,5
00094	12	4,5
00095	14	5



Schaumspeiseform

mousse mould
aro cuadrado para semifríos
cercle à mousse carré



matt poliert, fugenlos

satin polished finish, seamless
acabado satinado sin soldadura
mat satiné, sans soudure

	cm	↑ cm
00096	6 x 6	4,5
00097	8 x 8	4,5



Schaumspeiseform Herz

mousse mould heart
molde „corazón“ para semifríos
cercle à mousse „coeur“



matt poliert, fugenlos

satin polished finish, seamless
acabado satinado sin soldadura
mat satiné, sans soudure

	cm	↑ cm
00116	8 x 9	4,5



Tortenring

cake setting ring
aro de tarta
cercle à gâteaux



stufenlos verstellbar
adjustable
ajustables
ajustables

	Ø cm	↑ cm	
00040	16,5 - 32	7	ohne Griff / without handle



Backform

baking pan
marco pastelero
forme à gateaux



stufenlos verstellbar, aus flexiblem Edelstahl
adjustable
ajustable
ajustable

	cm	↑ cm	
00042	19 x 28 - 34 x 54	5	



Kuchen- / Quiche-Form

cake / quiche mould
molde tarta o quiche
moule à tarte ou quiche



Metall, Antihaft-Beschichtung, mit herausnehmbaren Bodenteil, rund gewellt
metal, non-sticking coating, with removable bottom, round, fluted
metal con revestimiento antiadhrente, fondo desmontable, borde rizado
métal avec revêtement antiadhérent, fond démontable, bord cannelé

	Ø cm	↑ cm	
77302	24	3,5	
77304	28	3,5	
77305	32	3,5	



Tortenheber

cake lifter
pala / bandeja para tarta
pelle / plateau à gâteau



spiegelblank, bessere Handhabung durch ergonomischen Griff
shiny surface, easy handling, ergonomic handle
superficie brillante, manejo fácil, ergonómico
brillant, pratique, sûr et ergonomique

	Ø cm	
00045	30	



Tortenteiler
 cake marker
 marcador de pasteles
 disque à marquer les parts



elfenbein, beidseitig verwendbar, mit 2 Griffen, 12 oder 16 Segmente
 ivory-coloured, double sided, with 2 handles, 12 or 16 pcs.
 polipropileno, color marfil, doble cara, con 2 asas, , 12 o 16 porciones
 polypropilène, couleur ivoire, 2 faces, avec 2 poignées, 12 ou 16 parts

	Ø cm	↑ cm
88060	26,5	2,5



Ausstellblech / Thekenblech
 display tray
 bandeja pastelera
 plaque pâtissière



hitzebeständig bis 230°C
 heat-resistant up to 230°C
 resistente al calor hasta 230 °C
 résistant à la chaleur jusqu'à 230°C

	cm	↑ cm
13377	40 x 25	2
13378	48 x 32	2
13379	60 x 40	2



Tablett „TREND“
 baking sheet
 placa pastelera
 plaque à pâtisserie



Ein Backblech wird zum Servier-Objekt/Serviertablett.
 A baking sheet which becomes a serving tray.
 Una bandeja pastelera que se convierte en una bandeja de servir.
 Une plaque à pâtisserie qui devient un plateau de service.

	cm	↑ cm
13380	32,0 x 21,5	2



Mehlschaufel
 scoop
 pala
 pelle à farine



stehende Schaufel, auch für Flüssigkeiten geeignet
 standing scoop, also applicable for liquids
 pala, ápto también para líquidos
 adaptée pour poudres et liquides

	cm	↑ cm	ltr.	Farbe / Colour
00610	25 x 9	4,5	0,25	White
00611	31 x 12	5,5	0,5	White
00612	35 x 13	6	0,7	White



Sterntüllen-Satz, 10er Set

set of star tubes, 10 pcs. set
juego de 10 boquillas estrella
jeu de 10 douilles en étoile



aus einem Stück gezogen, 10-teilig: 4, 5, 6, 7, 8, 9, 10, 12, 13, 15 mm
made in one piece, 10 pcs. set: 4, 5, 6, 7, 8, 9, 10, 12, 13, 15 mm
fabricación de 1 sola pieza 4, 5, 6, 7, 8, 9, 10, 12, 13 y 15 mm
fabrication d'une seule pièce 4, 5, 6, 7, 8, 9, 10, 12, 13 et 15 mm

77331



Lochtüllen-Satz, 10er Set

set of plain tubes, 10 pcs. set
juego de 10 boquillas lisas redondas
jeu de 10 douilles lisses rondes



aus einem Stück gezogen, 10-teilig: 4, 5, 6, 7, 8, 9, 10, 12, 13, 15 mm
made in one piece, 10 pcs. set: 4, 5, 6, 7, 8, 9, 10, 12, 13, 15 mm
fabricación de 1 sola pieza 4, 5, 6, 7, 8, 9, 10, 12, 13 y 15 mm
fabrication d'une seule pièce: 4, 5, 6, 7, 8, 9, 10, 12, 13 et 15 mm

77332



Tüllenkassetten-Set, 12er Set

pipng tubes set, 12 pcs. set
caja de 12 boquillas
boîte de 12 douilles



Farbe: elfenbein, 12 verschiedene Tüllen: 4 Sterntüllen, 4 Lochtüllen, 4 Garniertüllen
ivory-coloured, 12 different tubes: 4 star tubes, 4 plain tubes, 4 decoration tubes
polipropileno color marfil, 12 boquillas: 4 estrellas, 4 redondas, 4 decorados surtidos
polypropylène couleur ivoire, 12 motifs différents: 4 en étoile, 4 ronds, 4 décors assortis

↑ cm

77333

6



Spritzbeutel

pastry bag
manga pastelera
poche pâtissière

Baumwollgewebe mit starker Spezialbeschichtung, mit Saum und Tüllenverstärkung,
verschweißte Längsnaht, mehrmals verwendbar, undurchlässig
cotton fabric with strong special coating, with upper seam and reinforced tip, welded seam,
useable several times, impermeable
tejido algodón con revestimiento especial muy resistente y refuerzo en costura y punta para
uso alimenticio, costura soldada, reutilizable, impermeable
toile de coton avec revêtement spécial très résistant, couture soudée, base pour la douille
renforcée, réutilisable, imperméable

→ cm

77325

50



Salatschleuder „XXL“

salad spinner
 escurre verduras
 essoreuse à salade



ideal um größere Mengen Gemüse, Früchte oder Salat nach dem Waschen zu trocknen, inkl. Ablaufschlauch

ideal for drying large amounts and fruits after washing, removable inner basket with crank handle

ideal para escurrir gran cantidad de frutas y verduras después del lavado, cesta interior desmontable

idéale pour essorer une grande quantité de salade ou légumes après leur lavage, panier intérieur

	Ø cm	↑ cm	ltr.
88733	43	52	25



Seiher

strainer
 colador
 passoire



mit 2 Muschelgriffen
 with 2 shell shaped grips
 con dos asas
 à 2 anses moulées

	Ø cm	↑ cm
00780	36	19



Backhandschuhe

baking mittens
 manoplas de panadero
 gants de boulanger

Leder, gefüttert, Einheitsgröße, mit Stulpen, extrem hitzebeständig bis 250°C
 leather, inner lining, one size, with cuffs, extremely heat resistant up to 250°C
 cuero interior forrado, talla única, resiste a temperaturas hasta 250°C
 cuir intérieur doublé, taille unique, résiste à maxi 250°C

	→ cm
88090	45



Pizzaschaufel

pizza peel
 pala de pizza
 pelle à pizza



	cm	→ cm
88080	35 x 30,5	90
88081	35 x 30,5	130



Pinsel

brush
brocha
pinceau pâtissier



weißgebleichte, naphtalinfreie Borsten, temperaturbeständig von -40°C bis +95°C
bleached bristles, heat-resistant from -40°C to +95°C
cerdas blanqueadas, resistencia térmica -40°C hasta +95°C
soies blanchies sans naphtaline, résistance de -40°C à +95°C

	cm	→ cm
77350	4 x 1	23,5
77351	5 x 1	23,5
77352	6 x 1	24
77353	7,5 x 1	24



Gewürzkasten

condiment container
especiero
boîte à épices ou ingrédients



matt poliert, 4 herausnehmbare Einsatzschalen je 0,5 l, Scharnierdeckel aus Polycarbonat
satin polished finish, 4 removable inserts each 0,5 l, hinged polycarbonate lid
acabado mate, cuatro contenedores en propileno, capacidad de cada uno 0,5l, tapa policarbonato alta calidad con bisagra
mat, 4 compartiments de 0,5 L en polypropilène, couvercle polycarbonate à charnières

	cm	↑ cm	ltr.
71700	31 x 15,5	9,5	4 x 0,5

Einsatzschale / insert / contenedor 0,5 L / récipient 0,5 L

	cm	↑ cm	ltr.
71701	14,2 x 7,5	7	0,5



inklusive Löffel

Vorratsdose

canister with spoon
bote con cuchara
pot en verre avec cuillère



Glaskugel mit Löffel, Schraubdeckel mit aromadichtem Verschluss, Edeltahl-Löffel mit magnetischem Silikongriff, 1 Stck.
tight cover, stainless steel spoon with magnetic silicone handle, 1 pc.
acero inoxidable, tapa de vidrio ajustable, cuchara inox con mango magnético, 1pc.
pot en verre avec cuillère avec manche aimanté revêtu de silicone, couvercle à visser pour conserver les arômes, 1 pz.

	Ø cm	↑ cm	ltr.
00636	20	18	3



Vorratsdose mit Deckel

canister with lid
contenedor con tapa
pot en verre avec couvercle



Glaskugel mit Schraubdeckel, aromadichtem Verschluss, 1 Stck.
glass ball, aroma-tight screw cap, 1 pc.
bola de cristal, tapa de rosca para conservar el aroma, 1 pz.
boule de verre, bouchon à vis de l'arôme étanche, 1 pc.

	cm	↑ cm	ltr.
00637	12,5 x 19	18	1



Schneidbrettständer

cutting board rack
soporte para tablas
rack pour planches à découper



für 6 Schneidbretter bis 25 mm Stärke, Lieferung ohne Deko
for 6 chopping boards up to 25 mm thickness
para 6 tablas de corte de 25 mm
pour 6 planches de 25 mm

	cm	↑ cm
88903	27 x 31	28



Bonspieß

bill spike
pinchanotas
pique-bons



Spieße aus flexiblen Kunststoff, mit stumpfen Enden zur Unfallverhütung
spikes made of flexible plastic, with blunt ends to prevent accidents
pinchos de plástico flexible
piques en plastique flexible

	cm	↑ cm	
88855	9 x 5,5	10,5	1 Spieß / 1 spike / 1 pincho / 1 pic
88856	20 x 5,5	10,5	3 Spieße / 3 spikes / 3 pinchos / 3 pics



Bonleiste

bill rail
portafichas
barre porte-bons



matt poliert, mit Kugel-Greifsystem, zur Wandmontage geeignet, auch mit Magneten nutzbar
satin polished finish, small balls hold the bills, suited for wall fastening, can also be used with magnets
acabado satinado, con sistema de bolas para colgar las notas para fijar en la pared, puede usarse con imán
mat satiné, avec billes pour fixer sans effort tous types de fiches et papiers, peut se fixer sur plaque aimantée

	cm	↑ cm
88900	40 x 8	2
88901	50 x 8	2
88902	60 x 8	2



Magnet-Messerhalter

magnetic knife rack
barra magnética para cuchillos
barre aimantée pour couteaux



mit 2 Magnetschienen und Haken, aus massivem Kunststoff, zur Wandmontage geeignet, Lieferung ohne Deko

with 2 magnet racks and hooks, strong plastic, suited for wall fastening
con 2 railes magnéticos y ganchos, plástico macizo, fijación en pared
avec 2 rails aimantés et crochets, plastique robuste, fixation murale

	→ cm
88910	33
88911	45
88912	60



Folien-Abreißvorrichtung, mit Abreißkante / Säge

clingfilm tear-off-dispenser
dispensador de film
dérouleur de film



mit Abreißkante / Säge-Messer, für Endlosfolie, als Tischgerät oder Wandgerät verwendbar
with saw, for endless rolls, can be fixed on the wall
con sierra para rollo de film continuo, se puede fijar en la pared
avec lame dentée pour rouleau de film, peut être fixé au mur

	cm	↑ cm	
88288	34 x 16	9	für Folienbreite 30 cm / for film width 30 cm para film ancho 30 cm / pour film largeur 30 cm
88287	49 x 16	9	für Folienbreite 45 cm / for film width 45 cm para film ancho 45 cm / pour film largeur 45 cm



Eiswaffel-Ständer

cornet stand
soporte cucuruchos
support à cornets



matt poliert, mit 4 Löchern, 2 x Ø 31 mm + 2 x Ø 26 mm
satin polished finish, with 4 holes, 2 x Ø 31 mm + 2 x Ø 26 mm
acero inoxidable con 4 agujeros 2 x Ø 31 mm + 2 x Ø 26 mm
inox, 4 trous - 2 x Ø 31 mm + 2 x Ø 26 mm

	cm	↑ cm	
11881	9,5 x 27,5	9	



Eiswaffel-Ständer

cornet stand
soporte cucuruchos
support à cornets



mit 4 Löchern, 2 x Ø 31 mm + 2 x Ø 26 mm
with 4 holes, 2 x Ø 31 mm + 2 x Ø 26 mm
con 4 agujeros, 2 x Ø 31 mm + 2 x Ø 26 mm
4 trous, 2 x Ø 31 mm + 2 x Ø 26 mm

	cm	↑ cm	
11894	24,5 x 9,5	9	



Küchentuchständer

kitchen roll holder
porta rollo de cocina
dérouleur papier essuie-tout



Lieferung ohne Deko
delivery without paper towel roll
se entrega sin rollo
livré sans rouleau de papier

	Ø cm	↑ cm	
70303	18	31	



Quetschflasche „MINI“, 4er Set

squeeze bottle, 4 pcs.
bote dosificador flexible, 4 pz.
bouteille verseuse souple, 4 pc.



mit Schraubdeckel und Verschlusskappe, ideal zum Servieren von Dressing und Saucen
with tight-screw and cap, ideal for serving dressing and sauces
tapa de rosca, con tapón, ideal para servir aliño y salsas
bouchon à vis de étanche, avec bouchon, idéal pour servir de vinaigrette et sauces

	Ø cm	↑ cm	ltr.	pcs.
93225	3,0	8,5	0,03	4
93226	3,5	9,5	0,05	4



Quetschflasche

squeeze bottle
bote dosificador flexible
bouteille verseuse souple



ideale Größe, um Speiseteller mit Saucen zu verzieren, mit Verschlusskappe
ideal size to garnish plates with sauces, with cap
tamaño ideal para decorar los platos con salsas o culis, con tapón
taille idéale pour la décoration sur assiette avec sauces ou coulis, avec bouchon

	Ø cm	↑ cm	ltr.
93154	5	18	0,2
93163	5,5	19	0,35



Quetschflasche

squeeze bottle
bote dosificador flexible
bouteille verseuse souple



	Ø cm	↑ cm	ltr.	Farbe / Colour
93240	7	21	0,35	Yellow
93241	7	21	0,35	Red
93242	7	21	0,35	White
93243	8	24,5	0,7	Yellow
93244	8	24,5	0,7	Red
93245	8	24,5	0,7	White



Quetschflasche

squeeze bottle
bote dosificador flexible
bouteille verseuse souple



mit Verschlusskappe
with cap
con tapón
avec bouchon

	Ø cm	↑ cm	ltr.	Farbe / Colour
93155	6,5	25	0,65	Yellow
93156	6,5	25	0,65	Red
93157	6,5	25	0,65	White



Quetschflasche

squeeze bottle
bote dosificador flexible
bouteille verseuse souple



	Ø cm	↑ cm	ltr.	Farbe / Colour
93222	9,5	25,5	1,1	
93223	9,5	25,5	1,1	
93224	9,5	25,5	1,1	



Dosierspender

dispenser
dispensador de salsa
doseur à sauce



	cm	↑ cm	ltr.
93151	13 x 7,5	27	1,25
93150	11 x 11	27	1,35

Dosierpumpe

dosing pump / riser tube
bomba de salsa, sola
pompe à sauce



Hubvolumen 30 ml
swept volume 30 ml
cada dosis 30 ml
30 ml par dose

	Ø cm	↑ cm
88271	4,5	40



Schüssel

bowl
ensaladera
saladier



	Ø cm	↑ cm	ltr.	Farbe / Colour
30260	32,5	10	4	
30263	40	12	8	
30266	47	14,5	14	
30261	32,5	10	4	
30264	40	12	8	

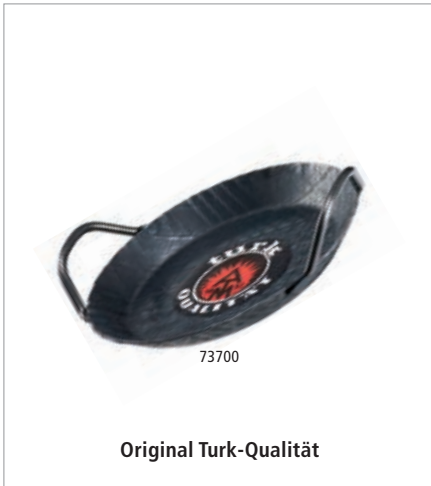

schmiedeeiserne Servierpfanne

pan wrought-iron
sartén forjada
poêle à frire forgée



mit zwei Griffen, hervorragende Brateigenschaft, Griffe und Stiele angeschweißt
with two welded handles, best bake properties, professional quality
con dos asas, excelentes propiedades de cocción, calidad profesional
2 anses, qualité professionnelle, excellente diffusion de chaleur, idéale pour la cuisson

	Ø cm	↑ cm	kg
73700	14 - 20	3	0,87
73701	17 - 24	3	1,15
73702	21 - 28	3,5	1,49
73703	24 - 32	3,5	1,85

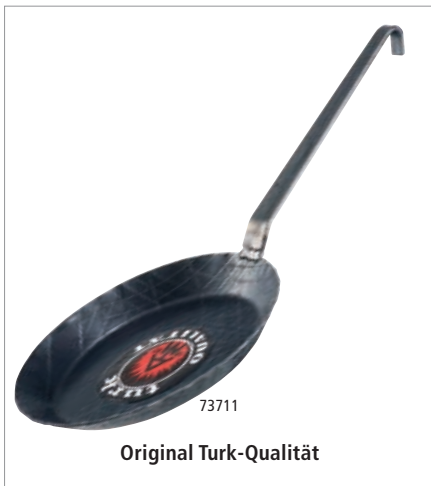

schmiedeeiserne Servierpfanne

wrought-iron pan
sartén forjada
poêle à frire forgée



mit geschmiedetem, angeschweißtem Hakenstiel, hervorragende Brateigenschaft
welded handle with hook, best bake properties, professional quality
mango soldado, con gancho al final, excelentes propiedades culinarias, calidad profesional
manche soudé à accrocher, qualité professionnelle, excellente diffusion de chaleur, idéale pour la cuisson sur tous feux, pour le four ou pour la table

	Ø cm	↑ cm	kg
73711	14 - 20	3	0,85
73712	17 - 24	3	1,17
73713	21 - 28	3	1,53
73714	24 - 32	3	1,99

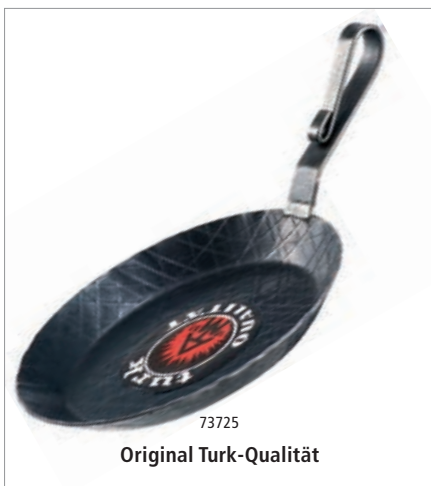

schmiedeeiserne Servierpfanne

pan wrought-iron
sartén forjada
poêle à frire forgée



mit geschmiedetem angeschweißtem gebogenem Hakenstiel, hervorragende Brateigenschaft
welded bended handle with hook, best bake properties, professional quality
con mango vuelto soldado, excelentes propiedades, calidad profesional
manche soudé replié, qualité professionnelle, excellente diffusion de chaleur

	Ø cm	↑ cm	kg
73725	14 - 20	3	0,87
73726	17 - 24	3	1,18
73727	21 - 28	3	1,54



Korkuntersetzer

cork mat
salvamanteles
dessous-de-plat liège



ideal für Servier- und Eisenpfannen
ideal for iron pan
ideal para servir en sartenes de chapa
idéal pour présenter les poêles forgées sur table

	Ø cm	↑ cm
73750	24	2



Eisenpfanne

iron pan
sartén de chapa
poêle à frire lyonnaise



schwere Ausführung, mit angeschw. Hakenstiel, extra hoher Rand, für den professi. Einsatz
heavy version, with flat welded handle with eye, extra high seam, professional quality
pesada, con mango plano, borde alto, para uso profesional
qualité lourde, manche plat, bord haut, pour usage professionnel

	Ø cm	↑ cm	kg
73739	14,5 - 20	4	1,04
73740	17 - 24	4	1,45
73741	20,5 - 28	4,5	1,87
73742	23 - 32	5	2,41
73743	27 - 36	6	3,11



Pizzaform

pizza dish
molde de pizza
moule à pizza



Blaublech, nicht beschichtet, lange Lebensdauer, zum professionellen Pizzabacken
metal sheet, without coating, long endurance, baking pizza professional
chapa azul, sin revestimiento, muy resistente, para uso profesional, larga duración
métal, sans revêtement, très résistant, pour usage professionnel, très durable

	Ø cm	↑ cm
73502	18 - 16,2	2,5
73503	20 - 18,2	2,5
73504	22 - 20,2	2,5
73505	24 - 22,3	2,5
73506	26 - 24,3	2,5
73507	28 - 26,3	2,5
73508	30 - 28,3	2,5
73509	32 - 30,3	2,5
73510	36 - 34,3	2,5
73511	40 - 38,3	2,5
73513	50 - 48,4	2,5



Pizzaform

pizza dish
molde de pizza
moule à pizza



Blaublech, rechteckig, Rand umgelegt, hitzebeständig bis 260°C
blue steel baking sheet, rectangular
chapa azul rectangular, borde plgado
métal, rectangulaire, bord plié

	cm	↑ cm
88255	50 x 35	2,5
88256	60 x 40	2,5





Hauben & Zubehör

covers & spare parts
campanas y piezas de repuesto
cloches et pièces de rechange

Qualitätshauben



GN Abdeckhaube

GN cover
GN cubierta
GN cloche



passend für GN Tablett, glasklarer Kunststoff, nahezu unzerbrechlich
suitable for GN trays, clear plastic, nearly unbreakable
apto para bandejas GN, plástico transparente, muy resistente a la rotura
pour bacs et plateaux GN, plastique transparent, très résistant à la casse

	cm	↑ cm	∅ mm	GN
11041	32,5 x 26,5	9,5	3	1/2
11042	53,0 x 32,5	9,5	3	1/1



stapelbar
stackable



GN 1/1 Haube „HOCHSTAPLER“

GN 1/1 cover
GN 1/1 campana
GN 1/1 cloche



glasklarer Kunststoff, Tablett fixiert sich auf der Haube - kein Rutschen möglich, nahezu bruchfest
clear plastic, tray fixes itself on the cover and can not slip off, nearly unbreakable
plástico transparente, la bandeja se fija a la tapa para que no se deslice, muy resistente a la rotura
en plastique transparent, le plat se fixe sur le dessous de la cloche pour ne pas glisser, très résistant à la casse

	cm	↑ cm	GN	fits to
11305	53 x 32,5	9	1/1	11300, 11290, 11295



GN Rolltophaube
GN rolltop cover
GN campana rolltop
GN cloche rolltop



patentiert, passend für GN-Behälter, -Tablets, etc., leichtgängig auf- und zuklappbar 90°
patented, suitable for GN trays, solid quality, 90° opening
patentada, para bandejas GN, apertura 90°
brevetée, pour plateaux GN, ouverture 90°

	cm	↑ cm	GN	
11008	53,0 x 32,5	19	1/1	vergoldeter Griff / gold plated handle pomo dorado / bouton doré
11010	53,0 x 32,5	19	1/1	verchromter Griff / chrome plated handle pomo cromado / bouton chromé
12008	32,5 x 26,5	15	1/2	vergoldeter Griff / gold plated handle pomo dorado / bouton doré
12010	32,5 x 26,5	15	1/2	verchromter Griff / chrome plated handle pomo cromado / bouton chromé



GN 1/1 Rolltophaube „SUNDAY“

GN 1/1 rolltop cover
GN 1/1 campana rolltop
GN 1/1 cloche rolltop



patentiert, mit Designer-Griff, ABS verchromt, leichtgängig auf- und zuklappbar
patent, with designer handle, chrome plated, easy to open and close
campana sola, policarbonato, asa cromada, fácil de abrir y cerrar
cloche seule, polycarbonate, bouton chromé, ouverture et fermeture faciles

	cm	↑ cm	GN
11016	53,0 x 32,5	19	1/1



GN 1/1 Haube

GN 1/1 cover
GN 1/1 campana
GN 1/1 cloche



klappbar, passend für GN 1/1-Behälter, GN 1/1-Tablets, etc., nahezu bruchfest
suitable for GN 1/1 chafing dish, GN 1/1 trays, GN 1/1 pans
para chafing dish GN 1/1, bandejas GN 1/1, cubetas GN 1/1
pour chafing dish, plateau, bac ou corbeille GN 1/1

	cm	↑ cm	GN
11013	53,0 x 32,5	6	1/1



klappbar
adjustable



Rolltophaube „PURE“

rolltop cover
campana abatible
cloche basculante



verchromter Griff
chrome plated handle
pomo cromado
bouton chromé

	cm	↑ cm
09013	44 x 33,5	17

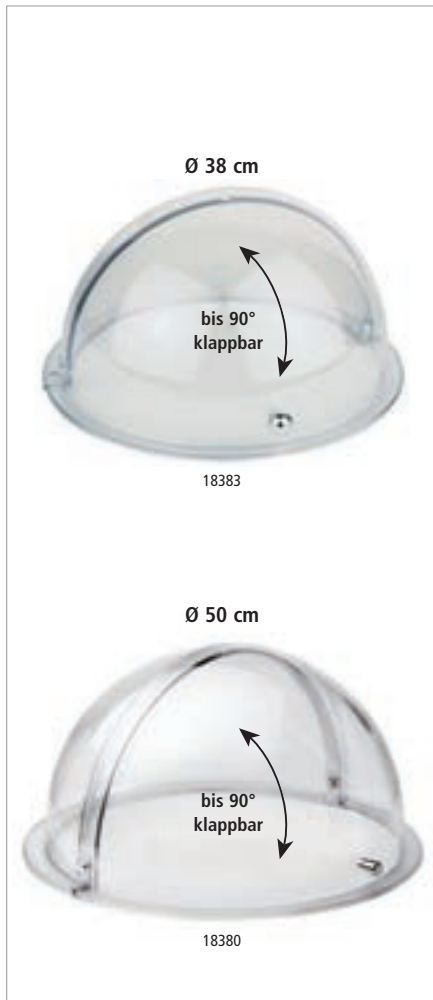

Rolltophaube

rolltop cover
campana abatible
cloche basculante



glasklarer Kunststoff, leichtgängig auf- und zuklappen 90°

solid quality, to be opened 90°

plástico transparente de alta calidad, apertura a 90°

plastique transparent résistant, ouverture 90°

	Ø cm	↑ cm	
18388	38	20	mit verchromtem Kugelgriff / with chrome plated handle con pomo cromado / avec bouton chromé
18387	38	20	mit vergoldetem Kugelgriff / gold plated handle pomo dorado / bouton doré
18380	50	26	mit verchromtem Zylindergriff / chrome plated handle pomo cromado / bouton chromé
18381	50	26	mit verchromtem Kreuzgriff / chrome plated handle pomo cromado / bouton chromé
18383	50	26	mit vergoldetem Kreuzgriff / gold plated handle pomo dorado / bouton doré



Frischhalte-Haube

cover
campana
cloche bombée



glasklar, Griff verchromt, schwere, stabile Ausführung

transparent, chrome knob, heavy stable quality

transparente, asa cromada, alta estabilidad

transparente, anse chromée, très stable

	Ø cm	↑ cm	fits to
15350	16,5	10	15130
15351	20,5	10	15131, 15141, 15136, 15271, 84241





06512

Frischhalte-Haube

cover
campana
cloche



glasklar, schwere stabile Ausführung, stapelbar
clear, heavy stable quality, stackable
transparente, alta estabilidad, apilable
transparente, très stable, empilable

	Ø cm	↑ cm	
06510	30	11,5	
06512	30	11,5	mit verchromtem Griff / with chrom plated handle con botón cromado / avec bouton chromé



06515

Frischhalte-Haube

cover
campana
cloche



glasklar, schwere stabile Ausführung, stapelbar
clear, heavy stable quality, stackable
transparente, alta estabilidad, apilable
transparente, très stable, empilable

	Ø cm	↑ cm	
06515	33	12,5	
06517	33	12,5	mit verchromtem Griff / with chrom plated handle con botón cromado / avec bouton chromé



06501

Frischhalte-Haube

cover
campana
cloche



	Ø cm	↑ cm	
06501	30	11	
06504	30	9,5	
06506	30	7	



Frischhaltehauben, 2er Set

covers, 2 pcs. set
campanas, set de 2 unidades
cloches, pack de 2



	Ø cm	↑ cm	
40752	30	11	



GN Kuppelhaube

GN cover
GN cúpula
GN cloche bombée

glasklarer Kunststoff, Griff verchromt
clear, chrome knob
transparente, asa cromada
transparente, anse chromée



	cm	↑ cm	GN	
11021	33 x 28	17	1/2	geschlossen / totally closed cerrada / totement fermée
11022	33 x 28	17	1/2	mit Front-Ausschnitt / one long side cut out gran apertura frontal grande ouverture frontale
11026	54 x 33	20	1/1	geschlossen / totally closed cerrada / totement fermée
11027	54 x 33	20	1/1	mit Front-Ausschnitt / one long side cut out gran apertura frontal grande ouverture frontale
11028	54 x 33	20	1/1	mit seitlichem Ausschnitt one small side cut out pequeña apertura lateral petite ouverture latérale



Deckel „PURE“ mit Löffelaussparung

cover with notched for spoons
tapa con espacio para la cuchara
couverture avec encoche pour la louche



	cm	↑ cm	fits to bowls
83600	19 x 19	1,5	84410, 84417, 84422, 83409, 83572, 84468, 83573, 84429, 84244, 84553
83601	25 x 25	1,5	84408, 84418, 84423, 83469, 83574, 83575, 83408, 84430, 84245, 84561, 84562, 84563, 84554
83602 <small>NEW</small>	32 x 32	1,5	84425, 84427



stapelbar
stackable



Deckel „FLOAT“ mit Löffelaussparung
 cover, with notched for spoons
 tapa, con espacio para la cuchara
 couvercle, avec encoche pour la louche



	Ø cm	↑ cm	fits to
83920	20,5	1,3	83908, 83909

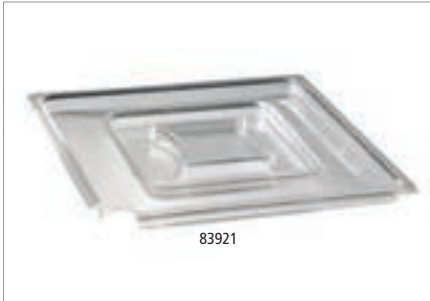

Deckel „FLOAT“ mit Löffelaussparung
 cover, with notched for spoons
 tapa, con espacio para la cuchara
 couvercle, avec encoche pour la louche



	cm	↑ cm	fits to
83921	19 x 19	1,3	83916, 83917
83922	25 x 25	1,3	83918, 83919



Frischhaltedeckel
 airtight cover
 tapa hermética
 couvercle hermétique



mit Silikondichtung, für luftdichtes Verschließen, Lebensmittel bleiben lange frisch
 with silicone sealing ring, bowls closed airtight, to keep food fresh for a long time
 junta de silicona para cerrar hermético. los boles y mantener los alimentos frescos más tiempo
 joint silicone pour fermeture hermétique et meilleure conservation des aliments

	Ø cm	fits to
10890	14	11865, 83700, 83701
10887	23	11875, 11846, 11848, 83702, 83703



zwei Öffnungspositionen des Deckels
 two opening positions of the lid

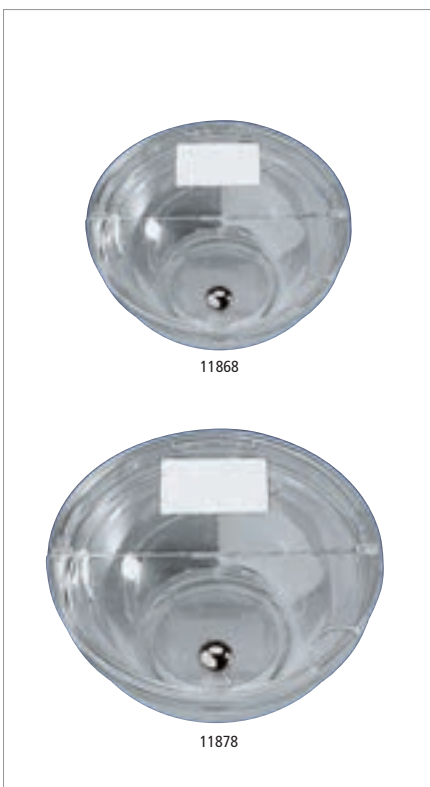

Schutzdeckel mit Löffelaussparung
 cover
 tapa
 couvercle



glasklar, klappbar, mit 10 Beschriftungs-Schildern
 transparent, with 10 cards for inscription
 plástico transparente, con 10 etiquetas para inscripción
 plastique transparent, avec 10 étiquettes pour inscription

	Ø cm	
11867	14,5	mit vergoldetem Griff / gold plated handle botón dorado / bouton doré
11868	14,5	mit verchromtem Griff / chrome plated handle botón cromado / bouton chromé
11877	23,5	mit vergoldetem Griff / gold plated handle botón dorado / bouton doré
11878	23,5	mit verchromtem Griff / chrome plated handle botón cromado / bouton chromé

Schilder, 10er Set / signs, 10 pcs. set / set de 10 cartelitos / set de 10 étiquettes

	fits to
12879	11867, 11868
11879	11877, 11878

Hauben & Zubehör



Deckel klappbar mit Löffelaussparung
cover hinged
tapa con bisagra
couvercle avec charnière



glasklar, mit Designer-Griff, verchromt, ohne Beschriftungsschild
clear, with designer handle, chrome plated, without card for inscription
transparente, con pomo de diseño cromado, sin tarjetas para inscripción
transparent, avec bouton chromé de design, sans étiquette pour inscription

Ø cm

10889 23,5



11875

Schale
bowl
cuenco
bol



Ø cm

↑ cm

ltr.

pcs

11875	23	10,5	2,5	6
11865	14	3,5	0,5	6
11866	7,5	6,5	0,09	36
11859	6,0	2,5	0,05	36



10777

10781

10661

white and
black

Kühlakku

cooler
acumulador de frío
accumulateur de froid



gefüllt mit Kühlflüssigkeit, nicht giftig, einfach im Gefrierfach einfrieren, unbegrenzt wiederverwendbar

freeze it in freezer, non toxic, filled with freezer-liquid, boundless reusable

se enfría en el congelador, no tóxico, se puede reutilizar sin límite

liquide eutectique qui accumule froid une fois dans le congélateur, non toxique, réutilisable sans limites

Ø cm

↑ cm

Farbe / Colour

10777	15	2,5	White
10781	10,5	2,5	White
10661	10,5	2,0	White
10752	10,5	2,0	Black



10782

10791

11101

Kühlakku

cooler
acumulador de frío
accumulateur de froid



gefüllt mit Kühlflüssigkeit, nicht giftig, einfach im Gefrierfach einfrieren, unbegrenzt wiederverwendbar

freeze it in freezer, non toxic, filled with freezer-liquid, boundless reusable

se enfría en el congelador, no tóxico, se puede reutilizar sin límite

liquide eutectique qui accumule froid une fois dans le congélateur, non toxique, réutilisable sans limites

cm

↑ cm

Farbe / Colour

10782	41 x 21	2,5	White
10791	25 x 19	2,5	White
11101	16 x 7,5	2,0	Blue



Türsymbol
door sign plate
pictogramas
pictogrammes

EDELSTAHL
STAINLESS
INOX

matt poliert, Materialstärke 1 mm, schwarzer Siebdruck, Rückseite selbstklebend
satin polished finish, back side auto-adhesive
acabado satinado, grosor 1 mm, serigrafía negra, reverso adhesivo
mat satiné, épaisseur 1 mm, sérigraphie couleur noire, dos adhésif

	Ø cm	
71401	7,5	Damen / ladies / damas / dames
71402	7,5	Herren / gents / caballeros / messieurs
71403	7,5	Damen und Herren / ladies und gents damas y caballeros / dames et messieurs
71404	7,5	Rollstuhl / disabled / discapacitados / handicapés
71405	7,5	WC / WC / WC / WC
71406	7,5	Rauchen / smoking / fumadores / fumeurs
71407	7,5	Nicht rauchen / no smoking / no fumadores / non-fumeurs
71408	7,5	Bitte hinsetzen / please sit / por favor siéntese / asseyez-vous SVP
71409	7,5	Garderobe / coats / guardarropa / vestiaire
71410	7,5	Handy verboten / no mobiles / apague el móvil / portables éteints
71411	7,5	„ZIEHEN“
71412	7,5	„DRÜCKEN“
71413	7,5	„PULL“
71414	7,5	„PUSH“
71415	7,5	„KEIN ZUTRITT“
71416	7,5	„NO ENTRY“
71419	16	Nicht rauchen / no smoking / no fumadores / non-fumeurs



Aufsteller „ACHTUNG RUTSCHGEFAHR“
stand
letrero
panneau

PP
POLYPROPYLEN

	cm	↑ cm	Farbe / Colour
71421	30 x 63	63	

Icon-Index / Material-Index



neuer Artikel
new item



spülmaschinengeeignet
dishwasher-proof



für Induktionsplatten
for induction use



niedriger Preis
hot price



nicht spülmaschinengeeignet
not dishwasher-proof



kühlbar
for cooling



Made in Germany



abwaschbar / wasserfest
water-proof



doppelwandig
double wall



GN-Größen
GN norm



mikrowellengeeignet
microwave-proof



bruchsicher
shatter-proof



stapelbar
stackable



nicht mikrowellengeeignet
not microwave-proof



Eigenmontage
self assembly



Antirutsch-Füßchen
non-slip feet



keine direkte Hitze
not direct heat



für Lebensmittelkontakt
food safe



Inhaltsangabe
volume



nicht für Backofen
not for baking oven



nicht für Lebensmittelkontakt
non food safe

APS - BSCI-Mitglied

APS engagiert sich für die Verbesserung von Arbeitsbedingungen.

Wir sind Partner der europäischen Organisation BSCI. Die "Business Social Compliance Initiative" (BSCI) ist eine Initiative von Unternehmen zur Verbesserung der Arbeitsbedingungen in der globalen Versorgungskette,

APS is a member of BSCI

APS is committed to the improvement of working conditions.

APS is a partner of the European organization BSCI. BSCI "Business Social Compliance Initiative" is an initiative of enterprises to improve working conditions in the global supply chain



APS Melamin - Garantierte Qualität

APS Melaminprodukte entsprechen der Richtlinie EG1935/2004 und 10/2011 der Europäischen Kommission. Diese enthält Bestimmungen für Materialien aus Kunststoff, welche mit Lebensmitteln in Berührung kommen. Wir arbeiten sehr eng mit den Zertifizierungsinstitutionen Intertek und TÜV zusammen und können somit die Lebensmittelsicherheit (LFGB Regulation) der APS Melaminartikel garantieren.

APS Melamine - Guaranteed quality

APS melamine products comply with directive EG1935/2004 and 10/2011 of the European Commission. This contains provisions for plastic materials which come into contact with foodstuffs. We work very closely together with the certification institutions Intertek and TÜV and are therefore able to guarantee the compatibility with foodstuffs (German LFGB regulation) of APS melamine articles.

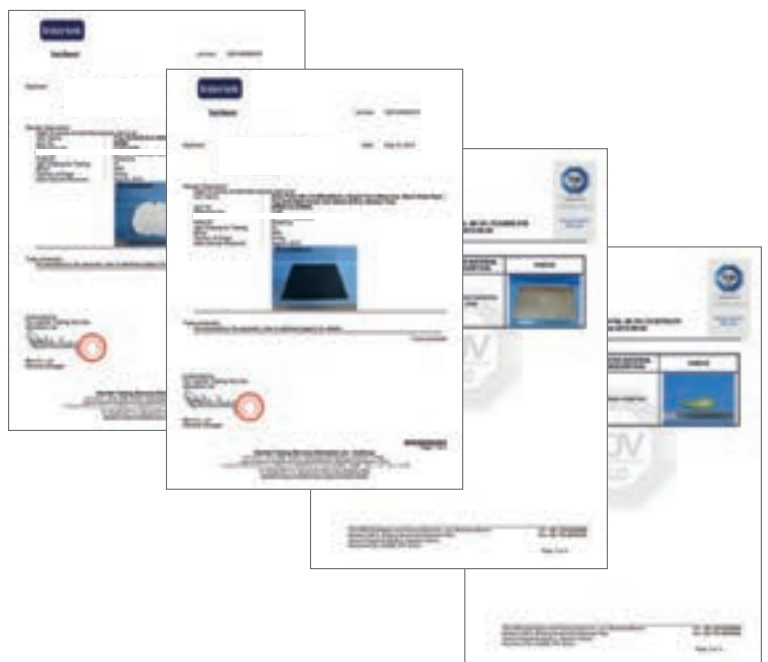

**Edelstahl 18/10 / Stainless steel 18/10**

Werkstoff 1.4301; rostfrei; langlebig; gute isolierende Eigenschaften; absolut hygienisch und nicht toxisch; recyclebar; nicht resistent gegen dauerhaften Kontakt mit Chloriden und Säuren (z. B. Kochsalz und Fruchtsäuren); sterilisierbar; Oberfläche lässt sich vielfältig polieren; nicht magnetisch; Gebrauchstemperatur bis ca. 400 °C

Pflege: pflegeleicht; maschinell oder per Hand mit milden Spülmitteln; möglichst keine Stahlwolle u. ä. verwenden; nach Erhitzung Schockabkühlung vermeiden

**Edelstahl (unspezif.) / Stainless steel (unspecific)**

niedrig nickelhaltige Edelstähle wie 14/4; nicht magnetisch; geringere allgemeine Resistenz als Edelstahl 18/10; Pflege: s. Edelstahl 18/10

**Edelstahl 18/0 / Stainless steel 18/0**

Werkstoff 1.4016; rostfrei; langlebig bei entsprechender Pflege; absolut hygienisch und nicht toxisch; gut härtbar, daher idealer Stahl für Tafelmesser, Tablett, Schneidwerkzeuge u. ä.; lässt sich hochglanzpolieren; für Nickelallergiker geeignet; magnetisch; nicht so chemikalienresistent wie Edelstahl 18/10; Gebrauchstemperatur bis ca. 400 °C

Pflege: maschinell oder per Hand mit milden Spülmitteln; Ablagerungen von Kalk und Reinigerresten nach dem Spülen unbedingt entfernen; niemals mit Stahlwolle reinigen

**Eisen / Iron**

nicht rostfrei; charakteristische, strukturierte Oberfläche mit unterschiedlichen Schattierungen; durch wiederholten Schmiedevorgang ist das Material stark verdichtet und sehr hart; langlebig bei entsprechender Pflege, Pflege: vor erstem Einsatz mit Öl und Kartoffelschalen „einbraten“; später nach jeder Reinigung einfetten; stets trocken lagern

**Gusseisen / Cast Iron**

langlebig bei entsprechender Pflege; geeignet für alle Herdarten (inkl. Induktion); speichert lange Wärme und gibt sie gleichmäßig ab; absolut hygienisch bei unbeschädigter Oberfläche; relativ schweres Material; Überhitzung fast nicht möglich; nicht schlagfest; magnetisch, Pflege: nach Gebrauch sofort mit heißem Wasser reinigen; bei Fleckenbildung mit Essig nachreinigen; niemals mit Stahlwolle reinigen; milde Spülmittel verwenden; stets trocken lagern

**Versilberter Stahl / Silver plated steel**

Edelmetallüberzug; nicht völlig säurefest; nicht über längere Zeit Sonnenlicht aussetzen

Pflege: niemals scheuernde Hilfsmittel verwenden; nur mit weichem Lappen und Spezialmitteln reinigen; keine Spülmaschinenreinigung!

**Verchromter Stahl / Chrome plated steel**

nichtedles Metall mit hartem Chromüberzug; nicht säurefest; nach Beschädigung der Chromschicht kein Schutz gegen Umwelteinflüsse

Pflege: niemals scheuernde Hilfsmittel verwenden; nur mit weichem Lappen

**Aluminium**

sehr leichtes Material; sehr gute elektrische und thermische Leitfähigkeit; korrosionsbeständig; nicht spülmaschineneeignet; Gebrauchstemperatur bis ca. +500 °C

**Porzellan**

spülmaschineneeignet; hitzebeständig bis ca. +220 °C

**GFK – Glasfaserverstärkter Kunststoff**

starr; nahezu unzerbrechlich; spülmaschineneeignet; Gebrauchstemperatur bis ca. +100 °C

**ABS – Acrylnitril-Butadien-Styrol**

sehr gute Oberflächenhärte; temperaturwechselfest; spülmaschineneeignet; Gebrauchstemperatur bis ca. +100 °C

**ACRYL – künstliches Harz**

farblos; glasartig; durchsichtig; nicht splitternd; chemisch modifiziert als Plexiglas®; wichtiger Pflegehinweis: nur handelsübliche Acrylspezialreiniger oder milde alkohol- und ammoniakfreie Reinigungsmittel verwenden; nicht spülmaschineneeignet; Gebrauchstemperatur ca. -40 °C bis ca. +50 °C

**EVA - Ethylenvinylacetat**

weich elastisch; glänzend; abwaschbar / wasserfest

Gebrauchstemperatur bis ca. +60 °C

**MF - Melamin**

sehr hart; stoß- und kratzfest; hygienisch; säurebeständig; spülmaschineneeignet; Gebrauchstemp. ca. -30 °C bis +70 °C

**MS - Kunststoff**

farblos; glasartig; durchsichtig; nicht spülmaschineneeignet; Gebrauchstemperatur ca. 0 °C bis ca. +70 °C

**PA - Polyamid**

starr; bruch- und schlagfest; mattglänzend; spülmaschineneeignet; Gebrauchstemperatur bis ca. +220 °C

**PC - Polycarbonat**

starr; nahezu unzerbrechlich; sehr stabil; formbeständig in kochendem Wasser; spülmaschineneeignet; mikrowelleneeignet; Gebrauchstemperatur ca. -30 °C bis ca. +100 °C

**PE - Polyethylen****HDPE – hochdichtes Polyethylen**

hart elastisch; unzerbrechlich; ausreichend formbeständig in heißem Wasser; glänzend; spülmaschineneeignet; Gebrauchstemperatur ca. -40 °C bis ca. +120 °C

NDPE – niederdichtes Polyethylen

weich elastisch; unzerbrechlich; kurzzeitig formbeständig in heißem Wasser; nicht glänzend; spülmaschineneeignet; Gebrauchstemperatur ca. -40 °C bis ca. +95 °C

**PP - Polypropylen**

hart elastisch; unzerbrechlich; umweltschonend recyclebar; spülmaschineneeignet; mikrowelleneeignet; Gebrauchstemperatur ca. -30 °C bis ca. +75 °C

**POL - Polyester**

noch kein Text für dieses Icon vorhanden, noch kein Text für dieses Icon vorhanden, noch kein Text für dieses Icon

**PS - Polystyrol**

starr; kratzfest; formbeständig in kochendem Wasser; nicht spülmaschineneeignet; Gebrauchstemperatur bis ca. +70 °C

**PVC - Polyvinylchlorid**

säurebeständig; schwer entflammbar; nicht spülmaschineneeignet; Gebrauchstemperatur ca. -50 °C bis ca. +60 °C

**SAN - Styrol-Acrylnitril**

gute Oberflächenhärte; temperaturwechselfest; spülmaschineneeignet; Gebrauchstemperatur bis ca. +100 °C

**Silikon**

hohe thermische Beständigkeit; gute Kälteflexibilität; spülmaschineneeignet; Gebrauchstemp. ca. -70 °C bis ca. +180 °C

**Tritan®**

starr; unzerbrechlich; absolut formbeständig; sehr hohe Chemikalienbeständigkeit; spülmaschineneeignet; Gebrauchstemperatur ca. -30 °C bis ca. +95 °C

Laserlogo Individual

perfekte Lasergravuren
perfectly Laser engravings
grabado perfecto por láser
marcage laser parfait



Unverwechselbar - Einzigartig -Imagefördernd Ihre individuelle Lasergravur von APS

Wir bieten Ihnen die Möglichkeit, unsere Produkte mit Ihrem individuellen Logo per Laser zu gravieren - einzigartig, unverwechselbar und bereits ab 10 Stück je Artikel. Die perfekte Beschriftung durch modernste Lasertechnologie ist spülmaschinenfest und somit dauerhaft auf allen Edelstahl- und Naturschieferprodukten, sowie auf versilberten und verchromten Metall-Artikeln umsetzbar. Machen Sie aus Ihren Gastnorm-Behältern Ihre ganz persönlichen Unikate und werten Sie Ihre Servierartikel mit Ihrem eigenen Logo auf.

- geringe Mindestbestellmenge von nur 10 Stück
- kurze Lieferzeiten
- Logos bis zu einer Fläche von max. 10 x 10 cm realisierbar

Distinct - Unique - Image enhancing Your individualised laser engraving by APS

We offer you the option of having your personalised logo engraved on our products - inimitable, unique, and available for delivery from only 10 pieces per product. The perfect inscription by use of the newest technology is dishwasher-safe and thus can be permanently applied to products made of stainless steel and natural slate, as well as silver-coated and chromed metal articles. Turn your gastrom container into your individual, one of a kind article and enhance your serving items with your own logo.

- minimum order quantity of only 10 pieces
- swift delivery
- feasible logos are those with a maximum size of 10 x 10 cm

Único, personalizado, promotor de imagen Grabado laser por APS

Podemos grabar su logo y así personalizar los productos APS a partir de mínimo 10 unidades por referencia.

Gracias a la novedosa tecnología de grabado por láser, la inscripción es perfecta y resistente al lavavajillas. Se puede aplicar a los artículos en acero inoxidable, pizarra natural, metal cromado y plateado.

- Cantidad mínima de solamente 10 unidades
- Realización rápida
- Tamaño de logos hasta máximo 10 x 10 cm

Unique, original, porteur d'image Marcage laser par APS

Nous pouvons graver votre logo et ainsi personnaliser les produits APS à partir de 10 pièces par référence.

Grâce à une technologie d'avant-garde de marcage par laser, l'inscription est parfaitement reproduite et résistante au lave-vaisselle. Ce type de marcage peut s'appliquer sur l'acier inoxydable, sur l'ardoise naturelle, sur le métal chromé ou argenté.

- Quantité minimum de seulement 10 unités
- Fabrication rapide
- Taille du logo jusque 10 x 10 cm

Index

0	00011 286	00012 286	00013 281	00015 158, 276	00016 158, 276	00017 281	00018 152, 278 396	00019 159, 278	00020 159, 278	00021 285	00022 283	00023 284	00024 157, 276	00025 159, 278	00026 159, 278	00027 156, 275	00028 156, 275	00029 156, 275	00030 284	00031 158, 277	00032 247	00033 303, 443	00036 284	00037 283	00040 495	00042 495	00043 455	00044 455	00045 495	00046 93, 266	00048 454	00050 454	00052 453	00053 156, 275	00054 453	00056 453	00058 159, 279	00059 443	00060 282	00062 304	00063 304	00064 81, 264	00065 81, 264	00067 81, 264	00069 280	00070 285, 286	00071 284	00073 443	00074 285	00075 78	00076 286	00078 283	00079 283	00081 77	00082 77	00084 77	00085 78	00087 77	00089 77	00090 454	00091 454	00092 494	00093 494	00094 494	00095 494	00096 494	00097 494	00098 494	00099 494	00100 375	00105 493	00106 493	00107 493	00108 375, 493	00110 494	00111 438	00113 494	00114 494	00116 494	00193 115	00208 375	00215 158, 276	00216 158, 276	00291 157, 277	00292 157, 276	00311 158, 277	00362 285	00363 285	00381 77	00382 77	00383 77				
	00384 77	00385 77	00388 77	00389 82	00391 82, 83	00392 82, 83	00393 82, 83	00394 82, 83	00395 82	00396 82	00397 82	00398 82	00399 82	00401 316	00408 288	00444 92, 265	00462 92, 265	00463 92, 265	00464 92, 265	00466 92, 265	00468 93, 240, 266	00469 93, 240, 266	00500 86, 448	00501 86, 448	00502 87, 399, 449	00503 87, 399, 449	00506 86, 448	00507 86, 448	00508 87, 399, 449	00510 86, 448	00511 86, 448	00512 86, 448	00513 86, 448	00515 86, 448	00520 88, 450	00521 88, 450	00522 88, 450	00523 88, 450	00524 87, 449	00525 87, 449	00526 87, 449	00527 88, 450	00528 88, 450	00529 88, 450	00530 88, 399, 450	00531 88, 399, 450	00532 88, 399, 450	00533 88, 399, 450	00535 88, 399, 450	00536 88, 399, 450	00537 88, 399, 450	00538 88, 399, 450	00540 88, 399, 450	00541 88, 399, 450	00542 88, 399, 450	00543 88, 399, 450	00547 86, 448	00548 86, 448	00549 86, 448	00550 87, 449	00551 87, 449	00552 88, 399, 450	00553 88, 399, 450	00554 88, 399, 450	00555 88, 399, 450	00560 452	00561 452	00562 452	00563 452	00564 452	00565 452	00566 452	00567 452	00572 281	00573 281	00574 456	00575 457	00576 455	00579 456	00580 457	00581 159, 279	00582 453	00583 453	00584 453	00585 453	00588 389, 466	00589 389, 466	00590 389, 466	00591 389, 466	00592 389, 467	00593 389, 467	00594 389, 467	00595 389, 467	00596 389, 467	
	00597 389, 467	00598 467	00600 460	00601 461	00602 461	00603 460	00604 460	00605 461	00606 461	00607 461	00610 496	00611 496	00612 496	00615 412	00616 412	00617 412	00618 412	00619 412	00620 412	00621 412	00623 272	00625 272	00626 272	00627 272	00630 411	00632 411	00635 303, 442	00636 149, 499	00637 149, 499	00645 462	00646 462	00647 462	00648 462	00649 462	00650 389	00652 81, 264	00662 387, 464	00664 387, 464	00666 387, 464	00668 387, 464	00670 387, 464	00671 388, 465	00672 388, 465	00673 388, 465	00677 269	00682 269	00685 471	00686 471	00687 471	00688 471	00691 269	00692 269	00700 285	00710 388, 465	00711 388, 465	00712 388, 465	00713 388, 465	00714 388, 465	00715 388, 465	00716 388, 465	00717 388, 465	00720 388, 465	00721 388, 465	00722 388, 465	00723 388, 465	00730 388, 465	00740 477	00744 477	00745 477	00746 477	00747 477	00765 301, 440	00766 301, 440	00768 301, 440	00771 491	00772 294, 490	00773 293, 439	00774 293, 439	00775 292	00776 292	00777 292	00778 292	00779 294, 490	00780 498	00781 293, 439	00782 293, 439	00783 293, 439	00785 490	00831 386, 463	00832 386, 463	00833 386, 463	00834 386, 463	00860 91	00865 68	
	00866 68	00867 67	00868 67	00869 67	00870 67	00871 67	00872 67	00873 67	00874 67	00875 67	00876 67	00877 67	00879 66	00880 66	00881 66	00882 66	00883 147	00884 147	00885 147	00901 140	00920 70	00921 70	00922 70	00923 70	00929 71	00930 71	00931 71	00932 71	00935 63, 287	00936 63, 287	00937 64, 287	00938 64, 287	00939 64, 287	00941 63	00942 63	00945 63	00950 147	00951 147	00952 147	00953 146, 347	00954 146, 347	00955 147	00956 147	00957 147	00958 119, 148	00959 146, 347	00960 65, 114	00961 71	00962 71	00963 71	00964 71	00966 63	00968 64	00969 64	00971 64, 287, 289	00972 133	00973 46, 47, 62	00975 64	00978 133	00983 71	00984 65	00985 71	00986 263	00987 263	00988 63	00989 65, 115	00990 47, 62	00991 46, 47, 62	00992 62	00993 47, 62	00994 62, 287	00995 62, 287	00996 62, 287	00997 65	00998 64	00999 64	01000 64	01309 79	01310 79	01311 79	01312 79	01313 79	01314 79	01317 79	01318 79	01322 79	01323 79	01324 79	01325 79	01332 79	01335 79	01336 90, 431	01338 79	01348 79	01349 79
	01358 79	01415 74	01416 74	01420 74	01425 74	01699 93, 266	01709 80	01710 80	01711 80	01712 80	01723 79	01725 79	01738 79	01748 79	02038 157, 277	02039 157, 277	02310 81, 264	02311 81, 264	02312 81, 264	03013 312	03015 312	03016 313	03020 314	03025 314	03026 313	03027 313	03028 313	03033 313	03038 314	03039 314	03098 314	03099 314	03610 286	03611 286	03614 110	03615 110	03616 110	03617 110	03618 110	03619 110	03620 110	03621 110	03622 108, 234	03623 108, 234	03814 77	03824 77	04000 310	04001 310	04002 310	04003 310	04004 310	04005 311	04006 311	04008 312	04012 310	04013 310	04015 315	04016 315	04017 315	04018 315	04020 312	04021 312	04022 312	04024 312	04025 312	04026 312	04035 311	04036 311	04037 311	04445 271	04446 271	04447 271	06401 81, 264	06501 511	06503 81, 264	06504 511	06506 511	06510 81, 93	240, 264	511	06512 25, 240, 511	06515 218, 511	06517 25, 218, 511	06701 81, 264	08201 78	09000 57	09001 57	09002 57	09003 57	09010 57, 80	09011 57	09012 57	09013 57, 80, 509	09016 57	09020 57
	09021 57	09022 57	09023 57	09080 133	09081 133	09082 141	09083 141	09085 133	09090 134	09093 135	09099 133	09100 134	09102 134	09104 134	09106 57	09200 135	09202 135	09204 135	09923 228	09924 228	10316 303, 442	10317 303, 442	10318 443	10319 443	10320 443	10321 444	10322 444	10323 444	10325 444	10326 444	10327 444	10328 444	10329 444	10330 444	10331 444	10332 444	10334 444	10335 444	10336 444	10500 105, 413	429	10501 105, 413	429	10502 105, 413	429	10608 104	10661 49, 142 143, 514	10663 103	10668 128	10700 98	10701 104	10703 104	10704 104	10707 104	10708 104	10709 104	10710 104	10711 104	10712 104	10713 104	10714 104	10715 104	10716 104	10717 101, 104	10720 98	10730 98	10740 99	10750 103	10752 95, 514	10753 96	10754 96	10755 102	10756 102	11010 136, 138 140, 334	11013 509	11016 53, 509	11018 39, 44, 68 334	11020 58, 72	11021 334, 512	11022 334, 512	11023 58, 72	11024 58, 72	11025 58, 72	11026 334, 512	11027 324, 333 334, 348	11028 334, 512	11032 58, 72	11038 58, 72	11040 58, 72	11041 59, 75, 172 508, 512					
	10777 49, 104 142-144 514	10778 128	10781 514	10782 39, 53, 514	10787 96	10788 99	10789 99	10791 57	136-138	140, 141	514	10793 101	10794 101	10795 101	10796 101	10797 101	10798 101	10799 101	10800 98	10801 104	10803 104	10804 104	10805 54, 55, 100	10806 54, 55, 100	10807 104	10808 104	10809 104	10810 101	10812 104	10814 104	10820 98	10825 102	10830 103	10833 103	10835 102	10840 102	10850 102	10851 105, 431	10853 105, 431	10855 99, 105	10859 102	10860 54, 100	10862 55, 100	10864 55, 100	10865 54, 100	10867 54, 55, 100 104	10870 50, 103	10871 50, 103	10872 51, 103	10873 51, 103	10887 43, 49, 513	10889 514	10890 43, 49, 513	10907 102, 104	10910 162	10911 162	10912 162	10913 163	10914 163	10915 163	10916 163	10917 163	10921 162	10922 162	10923 162	10924 162	11000 58, 72	11008 136, 140 334, 509	11010 136, 138 140, 334	509	11013 509	11016 53, 509	11018 39, 44, 68 334	11020 58, 72	11021 334, 512	11022 334, 512	11023 58, 72	11024 58, 72	11025 58, 72	11026 334, 512	11027 324, 333 334, 348	11028 334, 512	11032 58, 72	11038 58, 72	11040 58, 72	11041 59, 75, 172 508, 512									
	11042 59, 75, 172 324, 349 508, 512	11048 58, 72	11065 58, 72	11100 58, 72, 140	11101 134, 135 139, 141 514	11110 58, 72	11111 78	11115 78	11118 39	11119 39, 239	11150 73	11155 73	11160 74	11165 74	11168 74	11170 73	11195 75	11210 52, 76	11211 52, 76	11212 52, 76	11220 52, 76	11222 52, 76	11230 53	11244 368	11252 59, 73	11290 59, 73, 75 390, 508	11295 59, 74, 75 508	11300 59, 73, 75 390, 508	11302 75	11305 59, 75, 508	11310 59, 73	11312 390	11315 390	11319 390	11395 41	11396 41	11397 41	11398 41	11399 41	11422 129	11424 129	11426 129	11427 129	11431 129	11432 129	11433 129	11434 129	11435 129	11436 129	11437 129	11438 129	11439 129	11442 130	11444 130	11446 130	11449 130	11451 131	11455 131	11456 131	11466 151, 395	11467 151, 395	11470 76	11475 76	11495 120, 123	11496 123	11497 123	11498 123	11499 123	11503 140	11505 140	11510 138	11512 139	11514 138	11516 139	11522 121	11523 120, 121	11524 120	11526 120	11527 120	11528 121	11529 121	11533 141	11538 141	11540 136	11541 136	11542 13									

11553	335	11846	142, 143	11999	152, 278	13622	80	15165	18, 19	15412	30	15506	34, 35	30121	116, 229
11555	335		513		396	13910	43	15166	18, 19	15413	30	15507	29, 34, 35	30122	116, 229
11556	148	11847	143	12000	58, 72	13911	43	15167	18, 19	15414	30		345	30123	85, 447
11557	68, 115	11848	142, 143	12008	509	13915	43	15200	15	15415	30	15508	29, 35, 345	30124	85, 447
11558	115		513	12010	509	13916	43	15201	15	15416	30	15509	28, 35, 345	30126	85, 447
11562	148	11849	143	12040	58, 72	13920	42	15202	15	15417	30	15510	35, 345	30127	85, 447
11563	150	11859	131, 132	12050	125	13921	42	15203	15	15418	30	15511	34, 35, 345	30136	85, 447
11566	150		514	12051	125	13925	42	15204	15	15419	30	15512	34, 35, 345	30137	85, 447
11572	148			12054	125	13926	42	15205	15	15420	30	15513	29, 31, 35	30200	343
11573	148	11865	43, 123	12055	125	13930	40	15206	19	15421	30, 34		108	30201	344
11574	150		513, 514	12065	58, 72	13931	40	15207	19	15422	30, 34, 345	15514	34, 35, 108	30202	344
11575	150	11866	132, 514	12100	58, 72	13935	40	15208	19	15423	30	15515	27, 34, 35	30203	341
11576	150	11867	513	12221	365	13936	40	15210	15	15424	31		108	30204	341
11579	443	11868	123, 142	12222	365	13940	37	15211	15	15425	31	15516	27, 35, 108	30210	344
11590	140		143, 513	12225	365	13941	37	15212	15	15426	31	15517	27, 35, 108	30220	343
11595	121, 122	11875	43, 122	12228	368	13942	37	15213	15	15427	31	15518	27, 35, 108	30230	343
11596	122		144, 513	12232	365	13950	38	15214	15	15428	31	15519	27, 35, 108	30240	344
11597	122		514	12233	360	13951	38	15215	14	15429	31	15520	27, 35, 108	30250	344
11598	122	11877	513	12235	365	13952	38	15216	14	15430	31	15521	27, 35, 108	30260	503
11599	122	11878	122	12236	360	13955	38	15217	14	15431	31	15522	27, 35, 108	30261	503
11600	306, 307		142-144	12240	361	13960	38	15218	14	15432	31	15523	27	30263	503
11601	307		513	12243	368	13965	126	15219	14	15433	31, 34, 345	15524	27	30264	503
11602	307	11879	281, 282	12244	368	13966	109	15220	14	15434	31	15525	27	30266	503
11603	307		513	12245	361	13980	49	15221	21	15435	31	15526	27	30270	344
11604	307	11881	501	12249	359, 360	13981	49	15222	21	15436	31	15530	27	30273	343
11605	307	11884	148		361	13985	50, 405	15223	21	15437	31	15531	27, 34	30274	343
11606	119	11885	148	12260	361	13987	50, 127	15224	21	15438	31	15532	27	30276	343
11607	119	11886	149	12285	370	13990	48	15225	21	15439	29	15533	27	30277	343
11616	46	11887	145	12287	369, 371	13995	50	15226	20, 21	15440	29	15534	27	30279	338
11617	46	11888	145	12290	360, 371	14910	43	15227	20, 21	15441	29	15535	27	30280	338
11618	362	11889	145	12291	357, 358	14911	43	15228	20, 21	15442	29	15921	304	30281	338
11620	46, 47	11891	145		370	14915	43	15230	15	15443	29	15925	304	30282	338
11621	46, 47	11892	124	12292	360, 371	14916	43	15231	15	15444	29	15926	304	30283	338
11622	46, 47	11893	124	12294	360, 371	14920	42	15232	14	15445	29	17910	38	30284	338
11623	47	11894	501	12295	353, 354	14921	42	15233	14	15446	29	17920	41	30285	338
11625	309	11901	367		356, 357	14925	42	15234	14	15447	29	17921	41	30286	335, 338
11626	46, 47	11902	367		358, 370	14926	42	15235	14	15448	29	17922	39	30287	338
11627	46, 47, 105	11903	366	12296	356, 370	14930	40	15236	20	15449	28	18380	510	30288	335, 338
11628	47	11910	367	12299	371	14931	40	15250	20, 21	15450	28, 32, 34	18381	510	30299	341
11629	47	11911	367	12300	359	14935	40	15251	21	15451	28	18383	510	30310	343
11630	305	11912	367	12310	368	14936	40	15252	20, 21	15452	28, 32	18387	137, 333	30320	343
11631	305	11913	367	12320	360	14940	37	15253	21	15453	28		510	30325	111, 344
11632	305	11915	366	12321	360	14941	37	15255	19	15454	28	18388	25, 137	30332	404
11633	305	11916	366	12322	352	14942	37, 45	15256	18	15455	28		139, 141	30333	411
11635	306	11917	366	12323	352	14950	38	15257	18	15456	28, 32, 34		240, 333	30340	340
11636	306	11920	370	12324	353	14951	38	15258	19		345		510	30341	340
11637	306	11921	155, 279	12325	353	14952	38	15259	18	15457	28	18389	44, 333	30342	340
11638	306		398	12350	359	14953	45	15261	19	15458	28, 32, 34	18394	133	30343	340
11639	306	11922	155, 279	12352	355	14954	45	15262	18	15459	28, 34	2		30350	340
11640	306		398	12353	355	14956	45	15263	18	15460	28, 32	23642	81, 264	30351	340
11650	308	11923	155, 279	12354	355	14965	126	15270	16	15461	33	24330	111	30352	340
11651	308		398	12355	364	14966	109	15271	16, 25, 510	15462	31, 33	24331	111	30353	340
11657	363	11925	151, 273	12356	364	14970	44	15272	16, 25	15463	32, 33	24332	111	30360	340
11658	363		395	12357	364	14980	49	15300	24	15464	32, 33	24334	111	30361	340
11667	369	11927	151, 273	12360	364	14981	49	15301	24	15465	32, 33	24335	111	30362	340
11671	369		395	12366	355, 358	14985	51	15302	24, 25	15466	32, 33	24336	111	30363	340
11672	369, 371	11930	156, 275	12370	355	14987	51, 127	15303	24, 25	15467	32, 33	24338	111	30370	340
11675	361	11931	156, 275	12371	355	14990	48	15310	24	15468	32, 33	24339	111	30371	340
11678	363	11940	399	12372	355	14995	51	15311	20, 24, 25	15469	33	3		30372	340
11680	362	11941	398	12385	358	15100	14	15312	24	15470	33	30000	250, 251	30373	340
11683	375	11942	398	12386	356	15101	14	15313	20, 24, 25	15471	33	30001	250, 251	30380	341
11685	362	11943	398	12390	358	15102	14	15320	23, 346	15472	33	30002	250, 251	30385	341
11686	362	11945	393	12391	356	15103	14	15321	23, 346	15473	32, 33	30023	93, 144, 266	30390	341
11692	363	11946	393	12393	358	15104	14	15322	20, 23, 346	15474	32, 33	30040	42, 94, 267	30410	349
11693	372	11947	393	12394	356	15105	14	15323	22, 23, 346	15475	33	30041	94, 267	30411	349
11695	363	11950	399	12396	357	15106	14, 22	15324	22, 23, 346	15476	32, 33	30042	42, 94, 267	30412	349
11696	363	11955	50, 51, 153	12397	355, 357	15107	14	15325	23, 346	15477	32, 33	30043	94	30413	349
11699	362		394	12398	357	15108	14	15326	22, 347	15478	33	30044	492	30414	348, 349
11720	161	11957	153, 394	12399	357	15110	14	15331	23, 346	15479	32, 33	30045	492	30415	349
11730	160	11960	153, 394	12403	358	15111	14	15332	23, 346	15480	33	30046	492	30416	349
11762	160	11962	153, 394	12404	356	15112	14	15334	23, 346	15481	33	30047	492	30440	342
11763	160	11965	153, 394	12415	109	15113	14	15335	23, 346	15482	33	30048	492	30441	342
11765	160	11966	153, 330	12483	359	15114	14	15340	15, 30	15483	33	30049	492	30442	342
11766	160		394	12484	359	15115	14	15341	15, 30, 185	15484	33	30050	49	30443	342
11775	150	11969	145	12879	281, 282	15116	13	15342	15, 30	15485	33	30052	49	30444	342
11776	150	11970	127		513	15117	13	15343	15, 30	15486	32, 33	30054	492	30445	342
11777	161	11971	128	12910	43	15120	20	15344	15, 30	15487	33	30055	492	30446	342
11778	161	11972	128	12911	43	15125	21	15345	15	15488	33	30057	492	30447	342
11780	161	11973	128	12915	43	15126	21	15346	15	15489	32, 33	30101	90	30450	342
11794	53	11974	128	12916	43	15127	21	15347	15	15490	32, 33	30102	90	30451	342
11795	53	11975	127	12920	42	15128	21	15348	15	15491	3				

33231	114	36069	404	40240	110, 331	40530	289	50607	328	60041	319	71450	281	75910	468
33232	110	36074	408	40242	120, 331	40531	289	50608	328	60042	319	71451	281	75911	468
33235	113	36075	411		335	40532	289	50610	328	60043	319	71452	281	75912	470
33238	114	36076	405	40243	120, 330	40534	289	50611	328	60118	318	71453	281	77302	495
33240	113	36077	405	40244	331	40535	290	50612	328	60270	90	71454	281	77304	495
33241	118	36081	402	40245	330	40536	290	50613	328	60310	90	71455	281	77305	495
33242	118	36082	402	40246	331	40537	290	50620	329	60502	320	71460	285	77315	484
33243	116	36083	410	40247	330	40538	291	50621	329	60503	320	71461	285	77325	497
33245	124	36087	402	40248	331	40539	291	50622	329	60505	320	71462	285	77331	497
33246	262	36088	402	40249	330	40540	289	50623	329	60509	319	71470	282	77332	497
33247	262	36089	402	40250	331	40541	289	50624	329	60510	319	71471	282	77333	497
33248	114	36090	409	40260	331	40542	290	50625	329	60511	319	71472	281	77338	491
33249	106	36233	270	40262	331, 335	40543	291	50626	329	60512	319	71474	281	77350	499
33250	106	36323	270	40263	331	40544	291	50627	329	60514	320	71480	282	77351	499
33251	106	38202	78	40264	331	40545	290	50628	329	60520	318	71482	282	77352	499
33252	106			40266	331	40546	290	50629	329	60521	318	71483	282	77353	499
33255	108, 250			40268	331	40547	290	50630	329	60522	318	71487	280	79553	68, 115
	251	4		40270	110, 331	40548	290	50631	329	60523	318	71488	280	79554	115
33256	108, 250	40007	154, 274	40272	331, 335	40600	252	50632	329	60524	318	71489	280	8	
	251		337, 397	40274	331	40601	252	50633	329	60525	317	71490	280	80021	379
33260	106	40009	154, 274	40276	331	40602	253	50634	329	60526	317	71491	280	80022	379
33261	106		337, 397	40278	331	40603	253	50635	329	60527	317	71498	280	80023	379
33262	106	40010	1154, 274	40280	331	40605	254	50640	324	60528	317, 318	71499	280	80024	379
33269	106		337, 397	40286	274, 337	40606	254	50641	324	60530	319	71700	499	80025	379
33270	106	40011	154, 274	40287	274, 337	40607	254	50642	324	60531	319	71701	499	80026	379
33271	106		337, 397	40290	44, 330	40610	252	50643	324	60532	319	73502	505	80027	379
33272	107	40012	154, 274	40291	44, 330	40611	252	50644	324	60533	319	73503	505	81000	377
33273	107		337, 397	40292	44, 121, 330	40612	253	50645	324	60534	319	73504	505	81095	377
33274	107	40013	154, 274	40293	44, 330	40613	253	50700	327	60535	317	73505	505	81100	377
33275	107		337, 397	40294	44, 334	40616	254	50701	327	60536	317	73506	505	81101	377
33276	107	40110	78, 343	40295	44, 333	40617	254	50702	327	60537	317	73507	505	81102	377
33277	107	40115	78, 343	40296	326	40618	254	50703	327	60538	317	73508	505	81104	377
33280	107	40125	336	40297	326	40620	252	50705	327	60539	317	73509	505	81106	377
33281	107	40127	336	40299	341	40621	252	50706	327	60540	319	73510	505	81108	377
34247	114, 236	40129	333	40300	300	40622	253	50707	327	60541	319	73511	505	81109	377
34248	114, 236	40130	154, 274	40310	297	40623	253	50708	327	60542	319	73513	505	81116	375
35050	374		337, 397	40311	297	40630	252, 254	50710	327	60550	321	73700	504	81191	378
35065	374	40131	154, 274	40312	297	40631	254	50711	327	60551	321	73701	504	81195	378
35070	374		337, 397	40313	297	40632	257	50712	327	60552	321	73702	504	81198	382
35343	374	40132	332	40320	297	40633	257	50713	327	60553	321	73703	504	81199	382
35350	373	40135	332	40330	299	40634	257	50720	327	60554	321	73711	504	81200	377
35711	89, 271, 451	40137	332	40331	299	40635	257	50721	327	61190	90	73712	504	81201	377
35720	270	40139	332	40404	309	40636	257	50722	327	61280	90	73713	504	81202	377
35730	270	40140	332	40405	309	40637	257	50723	327	61400	90	73714	504	81204	377
35734	270	40144	110, 332	40415	297	40638	257	50800	328	64001	373	73725	504	81206	377
35735	270	40146	332	40424	299	40640	252, 255	50801	328	64051	373	73726	504	81208	377
35912	89, 271, 451	40148	332	40425	284	40641	255	50802	328	64151	373	73727	504	81209	377
35930	270	40149	333	40435	295	40642	272	50803	328	64201	372	73739	505	81292	378
36002	408	40150	334	40436	295	40643	272	50805	328	65010	373	73740	505	81295	378
36003	404	40152	332	40437	295	40644	272	50806	328	65020	373	73741	505	81296	382
36004	404	40153	333	40438	295	40645	257	50807	328	65030	373	73742	505	81300	377
36007	417	40154	332, 335	40439	295	40646	257	50808	328	65033	373	73743	505	81302	377
36009	420	40159	332, 335	40440	297	40647	257	50815	328	65034	373	73750	504	81304	377
36010	416	40160	332	40441	297	40650	255	50816	328	65035	372	74201	475	81306	377
36011	416	40161	332, 335	40442	295	40660	255	50817	328	65065	372	74207	90	81308	377
36012	431	40179	336	40443	300	40661	258	50818	328	65066	372	74402	490	81391	378
36013	418	40182	336	40444	300	40662	258	50820	328	7		74403	490	81395	378
36014	427	40191	332	40450	297	40663	258	50821	328	70303	501	74404	490	81400	377
36015	418	40192	332	40453	299	40664	258	50822	328	71001	475	74700	489	81401	377
36017	420	40193	332	40454	299	40665	258	50823	328	71002	475	74701	489	81402	377
36019	427	40194	332	40455	296	40666	258	50900	326	71003	475	74702	489	81404	377
36020	403	40195	332	40457	296	40667	259, 304	50905	326	71004	475	74703	489	81406	377
36021	403	40196	332	40458	296	40668	259, 304	50910	326	71005	475	74705	489	81408	377
36022	418	40198	336	40460	296	40669	259	50915	326	71006	475	74706	489	81492	378
36024	418	40199	336	40461	296, 298	40670	66, 255	6		71009	474	74721	489	81495	378
36025	403	40200	268	40462	296, 298	40671	66, 255	60000	318	71010	474	74722	489	81502	377
36026	403	40201	268	40463	296	40672	66, 255	60002	318	71011	474	74731	492	81504	377
36027	418	40202	268	40464	296	40673	66, 255	60007	318	71012	474	74732	492	81506	377
36028	403, 404	40203	268	40470	298	40752	511	60008	318	71013	474	74733	492	81591	378
36029	418	40204	268	40472	298	49258	391	60009	318	71014	474	74750	267, 445	81595	378
36030	408	40205	268	40474	298	49310	391	60010	318	71015	474	75001	272	81602	377
36032	410	40206	268	40476	298	49638	391	60011	318	71400	455	75002	272	81604	377
36033	419	40207	268	40478	298	49738	391	60012	318	71401	515	75600	475	81606	377
36034	410	40208	268	40480	298	5		60014	318	71402	515	75800	472	81608	377
36036	409	40210	339	40482	299	50002	68	60015	318	71403	515	75801	473	81692	378
36037	419	40211	339	40485	300	50100	325	60016	318	71404	515	75802	473	81695	378
36038	408	40212	339	40486	302, 441	50105	325	60017	318	71405	515	75803	474	81700	377
36042	409	40213	339	40487	302, 441	50110	325	60018	318	71406	515	75804	474	81701	377
36044	405	40214	339	40488	302, 441	50205	325	60019	318	71407	515	75805	420	81702	377
36045	406	40215	339	40490	301, 440	50210	325	60020	321	71408	515	75806	472	81704	377
36046	406	40216	339	40494	301, 440	50215	325	60021	321	71409	515	75807	472	81706	377
36047	405	40220	331	40498	301, 440	50300	325	6002							

81904	378	82346	261, 263	83561	225	83742	208	83882	224	84004	230	84165	200	84298	198
81905	378	82347	261, 263	83562	225	83744	208	83884	225	84005	230	84166	385	84300	384
81906	378	82355	45, 69, 383	83563	225	83748	120, 384	83886	225	84006	230	84168	200	84301	121, 384
81907	378	82356	45, 69, 383	83564	225	83749	120, 384	83887	242	84007	230	84169	385	84302	384
81908	378	82357	45, 69, 383	83565	225	83750	384	83888	242	84017	245	84170	200	84303	384
81909	378	82359	261	83566	116, 225	83751	384	83889	242	84018	245	84171	200	84304	384
81910	378	82370	261	83567	116, 225	83752	384	83890	240	84020	246	84172	200	84305	120, 384
81911	378	82371	261	83568	116, 226	83753	120, 384	83891	240	84021	246	84174	203	84306	384
81997	379	82394	263		229	83754	384	83892	240	84022	209	84177	187	84307	384
81998	379	82395	263	83569	116, 226	83755	384	83893	240	84023	209	84178	187	84308	384
81999	379	82419	398		229	83756	384	83894	232	84024	209	84179	187	84309	384
82001	380, 384	82420	398	83570	226	83757	384	83896	232	84025	209	84180	193	84310	384
82003	380	82532	379	83571	226	83758	384	83897	246	84026	209	84181	193	84311	384
82004	380	83301	69, 383	83572	226, 227	83759	121, 384	83900	222	84035	246	84182	193	84324	199
82005	380	83303	69, 383		512	83760	385	83901	222	84036	246	84183	193	84325	199
82006	380	83304	69, 383	83573	226, 227	83761	385	83902	222	84039	289	84184	193	84326	199
82007	380	83305	69, 383		512	83762	385	83903	222	84040	234	84185	46, 47, 193	84327	199
82008	380	83309	94	83574	226, 227	83763	385	83904	222	84041	234	84186	46, 47, 193	84328	199
82010	380	83310	94		512	83764	385	83905	222	84042	234	84187	193	84329	199
82012	380	83311	94	83575	226, 227	83765	385	83906	222	84043	234	84188	46, 47, 193	84330	199
82013	380, 384	83400	225		512	83766	385	83907	222	84045	86, 448	84189	47, 193	84331	199
82014	380	83401	224	83587	237	83768	385	83908	222, 223	84046	39, 229	84195	47, 193	84334	199
82016	380	83402	225	83588	224	83769	385		513	84047	39, 45, 229	84196	47, 193	84335	199
82017	380	83403	63, 116, 225	83589	224	83770	385	83909	222, 223	84048	39, 229	84197	193	84336	199
82018	380	83404	225	83592	224	83772	385		513	84050	385	84198	47, 193	84337	199
82019	380, 384	83405	114, 225	83593	224	83773	385	83910	223	84053	385	84199	47, 193	84342	206
82020	380	83406	114, 117	83594	224	83777	235	83911	223	84054	385	84200	237	84343	206
82022	380		225	83597	224	83779	216	83912	223, 239	84058	385	84202	237	84348	205
82023	380	83407	114, 117	83598	224	83780	235	83913	223, 239	84059	385	84205	190	84349	205
82028	380		225	83599	224	83781	235	83914	118, 223	84061	385	84206	190	84350	205
82029	380, 384	83408	226, 227	83600	177, 195	83782	235	83915	118, 223	84062	385	84207	190	84351	205
82030	380		512		227, 512	83783	235	83916	118, 223	84065	385	84208	190	84352	205
82032	380	83409	226, 227	83601	177, 182	83784	235		513	84066	385	84209	190	84353	205
82034	380		512		183, 195	83785	216	83917	118, 223	84068	385	84212	454, 455	84354	204
82036	380	83410	226		227, 512	83786	216		513	84069	385	84213	454	84355	204
82037	380, 384	83411	227	83602	227, 512	83787	216	83918	118, 223	84080	232	84215	238	84360	192
82038	380	83412	227	83610	454	83788	216		513	84082	232	84216	238	84361	192
82040	380	83414	116, 226	83611	454	83789	216	83919	118, 223	84083	232	84217	211, 245	84362	192
82042	380		228, 229	83612	454	83790	216		513	84085	232	84218	211, 245	84363	192
82050	380	83415	226	83613	454	83791	216	83920	93, 144	84086	232	84220	238	84364	192
82051	380	83417	63, 117, 225	83614	455	83792	216		223, 235	84088	232	84221	238	84365	174
82059	380, 384	83418	117, 225	83615	146, 347	83793	216		266, 513	84100	201	84222	238	84366	174
82100	383	83419	226, 228	83616	455	83794	217	83921	223, 513	84101	201	84225	95	84367	174
82101	381	83424	242	83625	214, 225	83795	217	83922	223, 513	84103	201	84229	213	84373	174, 175
82104	381	83426	242	83626	225	83796	217	83923	223	84104	201	84230	213	84374	175
82106	381	83433	63, 224	83633	214	83797	217	83924	223	84105	201	84231	213	84375	175
82108	381	83434	224	83636	214	83798	235	83925	223	84106	201	84232	213	84376	175
82110	381	83435	233	83639	215	83799	216	83926	223	84107	202	84233	213	84377	174, 175
82112	381	83437	233	83640	215	83800	219	83928	204	84108	202	84234	213	84378	174, 175
82113	381	83438	233	83642	215	83801	246	83929	204	84109	202	84235	238	84379	174, 175
82114	381	83440	233	83643	215	83802	219	83932	207	84110	203	84236	238	84380	175
82116	381	83441	233	83648	214	83803	246	83933	207	84111	203	84237	238	84381	174, 175
82117	381	83443	233	83649	214	83804	219	83934	207	84112	203	84238	238	84383	217
82118	381	83444	233	83651	214	83806	219	83935	207	84113	203	84240	196	84385	217
82119	381	83446	233	83652	214	83808	219	83938	206	84114	203	84241	196, 510	84387	217
82120	381	83447	232	83654	214	83810	219	83939	206	84115	203	84242	196	84400	173
82122	381	83449	232	83655	214	83812	219	83940	208	84116	203	84243	196	84401	173
82123	381	83450	226	83696	235	83814	219	83941	208	84117	203	84244	195, 512	84402	173
82128	381	83451	226	83697	235	83816	219	83946	207	84118	203	84245	195, 229	84403	173
82129	381	83452	226	83698	235	83818	219	83947	207	84119	203		512	84404	173
82130	381	83453	226	83699	235	83820	219	83948	207	84120	212	84246	196, 197	84408	227, 512
82132	381	83454	226	83700	42, 49, 124	83822	219	83949	207	84121	212	84247	196, 197	84409	227
82134	381	83455	226		513	83824	219	83951	231	84122	212	84248	196, 197	84410	227, 512
82136	381	83456	226	83701	42, 49, 124	83826	219	83952	231	84123	210	84250	84, 446	84414	227, 229
82137	381	83457	226		513	83828	218, 239	83953	231	84124	210	84251	84, 446	84415	227, 229
82138	381	83466	116, 226	83702	42, 49, 124	83830	218	83954	231	84125	210	84252	84, 446	84416	227
82140	381		229		235, 513	83832	218	83955	195	84126	211	84253	84, 446	84417	227, 512
82142	381	83467	226	83703	42, 49, 124	83834	218	83956	195	84127	210	84255	191	84418	227, 512
82150	381	83468	226, 227		235, 513	83836	218	83957	195	84128	210, 241	84256	186	84420	227, 229
82151	381	83469	226, 227	83704	124, 235	83838	218	83958	195	84129	211	84257	197	84421	227
82159	381		512	83705	124, 235	83840	218	83960	220	84130	211	84258	197	84422	227, 512
82200	383	83479	224	83710	204	83842	242	83961	221	84131	211	84259	197	84423	227, 512
82201	69, 383	83480	63, 224	83712	204	83843	242	83962	220	84132	211	84260	213	84424	224, 226
82202	69, 383	83481	224	83714	205	83844	242	83963	220	84133	211	84261	213	84425	224, 226
82203	69, 383	83482	224	83716	205	83845	242	83964	220	84134	211	84262	191		227, 512
82204	69, 383	83483	225	83718	206	83847	157, 277	83965	220	84135	212	84263	191	84426	224, 226
82205	69, 383	83484	225	83720	206	83848	247	83966	221	84136	212	84264	191	84427	224, 226
82210	353, 358	83485	217	83721	205	83851	247	83967	220	84137	212	84265	91, 191		227, 512
82215	353, 358	83486	242	83722	206	83852	232	83968	231	84138	212	84266	186	84429	228, 512
82300	383	83487	242	83723	205	83854	232	83969							

84452	245	84577	179	84789	216	88911	500	93194	421
84454	245	84578	179	84790	216	88912	500	93200	419
84456	245	84579	179	84980	238	88920	485	93201	417
84458	245	84580	179	84981	238	88921	485	93206	437
84460	245	84581	178, 179	85040	234	88922	485	93211	416
84462	217, 237	84582	179	85041	234	88923	485	93212	416
84464	217, 237	84583	181	85042	234	88928	485	93213	426
84466	217, 237	84584	181	85043	234	88929	487	93214	426
84468	512	84585	184	88008	477	88930	488	93220	419
84470	185	84586	181	88019	490	88932	485	93222	503
84471	185	84587	181	88060	496	88933	485	93223	503
84472	185	84588	184	88080	498	88935	486	93224	503
84473	185	84589	181	88081	498	88936	486	93225	502
84474	185	84590	181	88090	498	88937	486	93226	502
84475	185	84591	184	88099	475	88938	486	93240	502
84476	185	84592	182, 183	88122	493	88939	486	93241	502
84477	185	84593	182, 183	88123	493	88940	486	93242	502
84478	185	84594	182, 183	88133	493	88941	486	93243	502
84479	185	84595	182	88144	382	88942	486	93244	502
84480	185	84596	182	88244	229, 382	88944	487	93245	502
84481	185	84597	183	88245	382	88946	487	93299	433
84482	185	84598	182	88246	382	88947	487	93300	424
84483	185	84599	182	88255	505	88948	487	93301	433
84484	185	84600	183	88256	505	88949	488	93302	433
84490	234	84700	169	88271	503	9		93303	430
84491	234	84701	169	88285	382	90901	134	93304	430
84492	234	84702	169	88287	501	90902	134, 135	93305	424
84493	234	84703	169	88288	501	93034	423	93306	425
84494	234	84704	169	88598	476	93101	429	93307	425
84509	170	84705	169	88601	490	93102	435	93308	300, 435
84510	170	84706	169	88607	489	93105	97, 429	93309	300, 435
84511	170	84707	168	88608	461	93110	436	93310	417
84512	170	84708	168	88609	476	93111	435	93311	417
84514	170	84709	168	88617	489	93112	428	93312	424
84515	170	84710	168	88618	489	93114	436	93313	424
84517	170	84711	168	88626	476	93115	436	93314	430
84519	172	84712	168	88627	476	93116	428	93315	430
84520	172	84720	189	88628	476	93120	428	93316	422
84521	172	84721	189	88636	476	93121	428	93317	426
84522	172	84722	189	88637	461	93122	432	93318	425
84523	170, 171	84723	189	88640	460	93123	438	93319	436
84524	170, 171	84724	189	88642	460	93124	432	93320	436
84525	171	84725	166	88643	472	93125	432	93321	152, 396
84526	170, 171	84726	166	88644	472	93126	437	93322	417
84528	170, 171	84727	166	88645	472	93127	437	93323	417
84529	170, 171	84728	202	88675	477	93128	423	93324	428
84530	171	84729	202	88688	491	93129	423	93325	417
84531	154, 236	84730	202	88701	488	93134	423	93326	416
	397	84731	202	88710	477	93135	437	93327	415
84532	154, 236	84732	202	88717	491	93136	417	93328	415
	397	84733	202	88718	491	93137	417	93329	415
84533	236	84740	167	88727	488	93138	417	93400	411
84534	236	84741	167	88733	498	93139	417	94144	434
84535	155, 273	84742	167	88810	478	93140	417	94145	434
	398	84743	167	88811	478	93141	429	94146	434
84536	155, 273	84744	167	88814	478	93143	434	94147	434
	398	84745	167	88815	478	93145	434	94148	434
84540	176	84746	167	88816	478	93146	434	94149	434
84541	176	84747	167	88818	478	93147	434		
84542	176	84748	167	88819	478	93148	434		
84543	176	84749	167	88820	478	93149	434		
84544	176	84750	243	88822	478	93150	503		
84545	177	84751	243	88823	479	93151	503		
84546	177	84752	243	88824	479	93152	423		
84549	177	84753	243	88826	479	93153	423		
84550	177	84754	243	88827	479	93154	502		
84551	176, 177	84755	243	88828	479	93155	502		
84552	176, 177	84756	243	88829	480	93156	502		
84553	177, 512	84757	243	88830	480	93157	502		
84554	177, 512	84758	243	88831	480	93160	437		
84555	181	84759	243	88834	480	93161	438		
84556	180, 181	84760	243	88835	481	93162	438		
84557	184	84761	243	88836	481	93163	502		
84558	180, 182	84762	243	88837	481	93164	428		
84559	182	84763	243	88839	481	93165	428		
84560	183	84764	243	88840	481	93166	430		
84561	182, 183	84770	192	88841	482	93167	430		
	512	84771	192	88843	482	93168	430		
84562	182, 183	84772	192	88844	482	93169	430		
	512	84773	192	88845	482	93170	438		
84563	183, 512	84774	192	88846	425, 483	93171	431		
84564	180	84775	244	88848	483	93172	432		
84565	180	84776	244	88849	483	93173	430		
84566	184	84777	244	88850	483	93174	431		
84567	178	84778	244	88852	484	93175	421		
84568	178	84779	244	88853	484	93179	416		
84569	179	84780	244	88854	484	93180	422		
84570	179	84781	244	88855	500	93181	422		
84571	178, 179	84782	244	88856	500	93182	422		
84572	179	84783	244	88900	500	93183	422		
84573	179	84785	216	88901	500	93189	426		
84574	179	84786	216	88902	500	93190	420		
84575	178	84787	216	88903	500	93191	421		
84576	178	84788	216	88910	500	93192	421		
						93193	421		

DEUTSCH

Artikel	Seite
A	
Abfalleimer	457
Abräumwagen	393
Abtropfmatte	430
Adapter / Zwischensteg	379
Allzweckgießer	301, 302, 440, 441
Antirutschmatte	28
Apfel- / Zwiebelteiler	484
Aschenbecher	452-457
Aufstrichmesser	487
Ausgießer	300, 435, 436
Ausstellblech	496
Austernmesser	481
B	
Backblech	382
Backform	495
Backhandschuhe	498
Bain-Marie	359-361, 368
Bar-Caddy	431
Bar-Set	431
Barlöffel	423
Barmaß	428
Barmatte	430
Becher	415, 417
Becher Emaille	257
Behälter	104, 151, 155, 273, 395, 445
Bento Box	31-33
Beschriftungsetiketten	280
Beschriftungskarten	280, 283
Besteckablage	246, 389
Besteckbehälter	50, 51, 151-159 273-278, 336, 337, 382, 394-398
Besteckständer	155, 279, 398
Besteckständer Melamin	151, 395
Bestecktaschen	321
Beton	152, 250, 251, 278 291, 396, 409
Bierglasträger	86, 411, 448
Blattschale Melamin	18, 19, 178, 179 201, 212, 232, 233
Bonleiste	500
Bonspieß	500
Bratenplatte	90
Brennflüssigkeit	375
Brennpastenbehälter Edelstahl	375
Brezel- oder Wurstständer	68, 115
Brotbox	146, 347
Brötchenschütte	326
Brötchenspender Edelstahl	148
Brottasche	340-342
Buffet Kühlset	48
Buffet Kühlset Edelstahl	53, 140, 141
Buffet-Set	40, 42, 43, 57, 133
Buffetbrett	68, 91
Buffetgestell	20, 22, 23, 45, 53, 109 110, 118, 119, 335, 346, 347
Buffetleiter	41, 122, 123
Buffetleiter Melamin	41
Buffetschilder	286
Buffetständer	90, 108, 124, 126, 234
Buffetständer Edelstahl	28, 29, 31, 34 35, 108, 345
Buffetständer Holz	20, 24, 25, 107 108, 250, 251
Buffetständer Metall	27, 34, 35 106-108
Buffetvitrine	134, 135, 145
Buffetvitrine Edelstahl	136-139
Butter- und Saucenwärmer	373
Butterdose	304
Butterroller	480
Butterservierer	304

C	
Cerealienspender	50, 51, 125-128
Cerealienspender Edelstahl	126
Chafing Dish	352-368, 372, 374
Chafing Dish Rolltop	359-361, 364
Champagnerkühler	405, 406, 437
Cocktailmesser	425, 483
Container	393
D	
Dariorform	375, 493
Deckel	15, 30, 93, 104, 122, 123 142-144, 177, 182, 183 185, 195 223, 227, 235, 266, 356, 358 512-514
Deckel Edelstahl	356, 358
Dekoriermesser	482
Dispenser	99
Dispenser Saft	50, 51, 54 55, 98-101, 103
Dispenser Saft / Milch	54, 55, 98-100
Display	110
Dose Vorrat	149, 499
Dosier- & Vorratsflasche	434
Dosierer Zucker	301-303, 440-442
Dosierpumpe	503
Dosierspender	503
Dressingtopf Edelstahl	94
Dressingtopf Melamin	94, 229
E	
Eier-Box	398
Eierbecher	247
Eierkorb	341
Eierschneider	475
Eis-Kugel-Former	419
Eisbox	44, 419
Eiseimer	404, 418
Eisportionierer	475
Eisschaufel	421
Eiswaffel-Ständer	501
Eiszerkleinerer	420, 421
Emaille	257-259, 304
Entkerner	481
Etagère	17, 65, 111, 113-115 236, 344
F	
Fadenschneider	479
Fast-Food Tablett	88, 399, 450
Feuerzange	372
Feuerzangenbowle	372
Fischentschupper / Fischschaber	484
Fischplatte	91, 236
Flambierbrenner	484
Flaschenhalter Wein	411
Flaschenkühler	50, 51, 402, 405 408-410, 412
Flaschenöffner	412, 432
Flaschenträger	411
Fleisch- / Gemüseplatte	77
Fleisch- / Gemüseplatte Edelstahl	58, 72
Folien-Abreißvorrichtung	501
Frischhaltedeckel	43, 49, 128, 513
G	
Gabel Fleisch	386, 387, 389 463, 464, 467, 468
Gabel Salat	389, 466, 469
Gebäckpalette	485
Gemüsemesser	482
Genusspalette	66
Getränkspender	99, 105
Gewürzkasten	499
Gewürzmühle	289, 290
Gewürzständer	300
Gläserhalter	438
Gläserschiene	411

Glasplatte	133
Glasumrandler	421
Glocke	270
GN Abtropfgitter	380
GN Behälter	120, 121, 377, 380 381, 383-385
GN Besteckbehälter	153, 330, 394
GN Buffet Kühlset Edelstahl	140
GN Buffet-Set	38, 75
GN Buffetgestell	46, 47, 105, 335
GN Buffetleiter	120, 121
GN Buffetplatte	69, 383
GN Buffetständer	29, 34, 35
GN Buffetvitrine Edelstahl	136, 138
GN Chafing Dish	352, 355, 356, 359
GN Deckel	378-381, 384
GN Haube	39, 44, 53, 59, 68, 75 172, 324, 333, 334 348, 349, 508, 509, 512
GN Konvektomatenblech	229, 382
GN Korb	44, 334
GN Korb Metall	348, 349
GN Korb Polypropylen	44, 110, 120 121, 324, 327 330-332, 335
GN Naturschieferplatte	46, 47, 62, 63
GN Partyplatte	82, 83
GN Rost	382
GN Schale Melamin	13, 14, 180, 181 184, 219, 221
GN Servierbrett	66
GN Serviergestell	117
GN Servierplatte	69, 383
GN Tablett	45, 69-71, 192, 383
GN Tablett Edelstahl	39, 52, 58, 59 72-78, 140, 239 390, 508
GN Tablett Melamin	20, 21, 28, 29, 32 34, 39, 45-47, 167, 168, 172, 173 182, 183, 189, 190, 192, 193, 195 200, 213, 218, 221, 223, 228, 229 239, 345, 390
Gourmetgläser	261
Grapfruitmesser	482
Grillzange	474
H	
Haube	25, 78, 81, 93, 134, 136 138, 140, 196, 218, 240 264, 334, 509-511
Haube Rolltop	25, 44, 57, 80, 133 137, 139, 141, 240 333, 509, 510
Haube Rolltop Edelstahl	368
Heizelement	360, 369, 371
Hobel	68
Holzbox	146, 150, 305-309, 347
Hot Plate	370
Hummerbrecher	475
Hygieneschutz	68, 115, 148
I	
Induktionskochplatte	353-358, 370
Isolierkanne	162, 163
J	
Julienneschneider	483
K	
Kaffeebecher	247
Kaffeedispenser Edelstahl	369, 371
Kaffeekanne	444
Kanne	95-97
Kanne Saft	96, 97
Karaffe Glas	95
Kartenhalter	280-286
Kartoffelstampfer	477
Käsehobel	68, 484
Kaviarkühler	93, 266
Kellnermesser	433

Kerzenleuchter	310-314
Kesselbesen	477
Konditorplatte	93, 266
Korb	44, 333, 341
Korb Edelstahl	28, 29, 34, 35 341, 343-345
Korb Metall	20, 22, 23, 343 346, 347, 349
Korb Polypropylen	110, 154, 274 325-329, 332-338, 397
Korkenzieher	433
Kronkorkenschale	412, 432
Kuchenform	495
Küchentuchständer	501
Kugelausstecher	478
Kühlakku	39, 49, 53, 57, 104 134-144, 412, 514
Kühlbox	48, 53, 140-141
Kühlkaraffe	95
Kühlmanschette	410, 411
Kühlschale	49, 93, 142-144, 266
Kühltablett	37, 45
Kühltablett Edelstahl	137, 139
L	
Likör- und Fondantrichter	491
Limettenpresse	426
Lochtüllen	497
Löffel	389, 467, 476
Löffel Backen	490
Löffel Feinkost	476
Löffel Fingerfood	210, 241, 242
Löffel Frittieren	490
Löffel Gourmet	269
Löffel Salat	246, 389, 466, 469
Löffel Sauce	470
Löffel Spaghetti	388, 462, 465, 470
M	
Magnet-Messerhalter	500
Mandoline	491
Menage	228, 295-300
Messbecher	492
Messerbänkchen	271
Messlöffelsatz	475
Metallrahmen für Induktionskochplatte	356-358, 370
Milch- / Zucker-Set	303, 442
Milchgießer/-kännchen	444
Milchkännchen	443
Milchkanne	102, 103
Moscow Mule	417
Mühle Chili	290
Mühle Pfeffer	289-291
Mühle Salz	289-291
Multi Rack Edelstahl	130, 131
Multibox	150
Muscheltopf	272
Müslispender	50, 51, 125-128
N	
Naturschiefer	63-65, 114, 115, 119 148, 263, 287
Naturschieferplatte	62-65, 115 263, 287
O	
Orangenschäler	479
P	
Palmbattschale Melamin	232, 233
Parmesan Menage	299
Partyplatte	82, 83
Passiermühle	489
Pastateller Melamin	227
Pastetenform	493
Pendelschäler	480, 483
Permanent-Ausgießer	435, 436
Pfanne	505
Pfannenwender	460
Pinsel	499

Pitcher	97, 429
Pizzaform	505
Pizzaschaufel	498
Pizzaschneider	480, 488
Platzsets	317-321
Platzteller	270
Pommes-Frites-Seiher	490
Portionsspender	443
Porzellan	45, 69, 102, 383, 353, 558
Q	
Quetschflasche	502, 503
Quiche-Form	495
R	
Rechnungstablett	89, 451
Reinigungsbürste für Ausgießer	435
Rezeptionsglocke	455
Rolltop-Set	57, 64, 133
Rührglas	429
S	
Saftdispenser	50, 51, 54, 55 98-101, 103
Saftkanne	96, 97
Salatschleuder	498
Sauciere	268
Schälchenspender	131
Schale	43, 122, 123, 131, 132 144, 503, 513, 514
Schale Beton	250, 251
Schale Edelstahl	42, 49, 78, 94 111, 267, 343
Schale Emaille	257, 259, 304
Schale Melamin	14-19, 22, 25 29-31, 34, 42, 49, 116, 118 124, 131, 132, 166, 169-171 174-180, 182-185, 188, 189 195, 198-239, 243-245, 267 345, 445, 510-513
Schaufel Eis	421, 474
Schaufel Mehl	496
Schaufel Mehrzweck	474
Schaufel Pommes	490
Schaumlöffel	388, 461, 462, 465, 468
Schaumspiseform	494
Schaumspesering	494
Schiefer	63-65, 114, 115, 119 148, 263, 287
Schilder	281, 282, 513
Schlüsselschnur	438
Schneebesen	477
Schneidebrettständer	500
Schneidebrett	38, 57, 140, 146 147, 347, 425
Schöpflöffel	386-389, 461-467
Sektkühler	402-407
Senftöpfchen	297
Service Tower	129
Servier- / Tortenplatte Edelstahl	92, 265
Servier- / Tortenplatte Melamin	240
Servierbrett	66, 67
Serviergabel	389, 467
Serviergestell	31, 112-119, 124, 148
Servierlöffel	246, 386-389, 461-468
Servierpfanne	90
Servierpfanne Schmiedeeisen	504
Servierschale	372, 373
Serviertablett	84-87, 399, 446-449
Servierwagen	392, 393
Serviettenhalter	160
Serviettenhalter Edelstahl	160, 161
Serviettenhalter Melamin	160
Serviettenringe	271
Serviettentaschen	321
Shaker	416, 417
Sicherheitsbrenner	375
Sieb	424, 425, 489, 491, 498
Snackholder	252-255

Snackpresenter	145
Sortierbox	154, 236, 397
Spachtel	487
Spargelschäler	478
Sparschäler	479
Speisekartenhülle	285
Speisenwärmer	374
Spießständer / Spieße	272
Spritzbeutel	497
Spritzflasche	300, 435
Ständer	300
Ständer Wein- / Sektkühler	404
Staubkappen	438
Sterntüllen	497
Stielkasserolle	272
Stift	96, 280
Stößel	422
Streichpalette	485
Streuer	292-294, 439, 477
Streuer Pfeffer	294-298, 442
Streuer Salz	294-298, 442, 490
Superbox	46, 47, 105
Suppenkelle	469
Suppentopf	357, 363, 366-368
Sushiboard Melamin	168, 208, 238
System-Theke	385
T	
Table Caddy	156, 275, 306, 307, 309
Tablett	17, 25, 71, 78, 86 326, 448, 496, 510
Tablett Edelstahl	52, 57, 74-81, 90 116, 134, 135, 229 264, 431
Tablett Fast Food	88, 399, 450
Tablett Holz	24, 25, 27, 87 88, 449, 450
Tablett Melamin	27, 34, 63, 86, 91 114-117, 146, 167, 168, 174-177 182, 183, 186, 187-189, 191 194-203, 208-211, 214, 217, 218 220, 224, 225, 238, 240, 245, 289 347, 448, 510
Tasse Melamin	177
Teebox	150
Teebrühsieb	267, 445
Teigrad	480
Teigschaber / Abstecher	488
Teller Emaille	258
Teller Fingerfood	239
Teller Melamin	31, 34, 166, 167, 170 176, 178, 198, 199 202, 208, 210, 225 240, 244, 247, 345
Thermo Tablett-Set	134, 135
Thermo-Box	391
Thermo-Box GN	390, 391
Thermo-Set	141
Tischrestebehälter	156-159, 275-278
Tischaufsteller	281, 286
Tischkartenhalter	284-286
Tischkrümelentferner	159, 279
Tischnummernschild	281
Tischrestebehälter	156-159, 275-278 317-321
Tischsets	317-321
Tortenheber	467, 470, 495
Tortennmesser	470
Tortenplatte	64, 81, 92, 93 240, 264-266
Tortenring	495
Tortenteiler	496
Tourniermesser	482
Trenner	236, 325
Tretbeutelhalter	457
Trinkbecher	415, 417
Tropfenschale Melamin	105, 431
Tüllenkassetten	497

Türsymbol	515
U	
Universalbox	148, 149
Universalkanne	444, 492
Untersetzer Edelstahl	89, 271, 451
Untersetzer Kork	504
Untersetzer Naturschiefer	64, 287, 289
Untertasse Melamin	177
V	
Vase	315
Verschluss	437
Verschluss Wein / Champagner	437
W	
Wachspapier	66, 255
Wanne	398, 399
Warenträger	82, 316
Wärme-Kies	375
Warnschild	515
Wasserbadschüssel	492
Wasserspender	99, 105
Weck	64, 260-263, 287
Wein-Vakuum-Pumpe	438
Weinkühler	402-407
Weinpumpe-Ersatzstopfen	438
Wender	387, 388, 460, 462 464, 465, 468 485-488
Windlicht	312-314
Z	
Zange	420, 461-474
Ziseliermesser	478, 479
Zitronenschnitzelpresse	267, 445
Zitruspresse	425-427
Zitrusteiler	426
Zuckerdosierer	301-303, 440-442
Zuckerkugel	303, 443
Zuckerspender	303, 442
Zuckertüten-Box Edelstahl	443
Zutatenbehälter	431

ENGLISH

item	page
A	
adapter	379
airtight cover	43, 49, 128, 513
apple / onion divider	484
ashtray	452-457
asparagus knife	478
B	
bain marie	359-361, 368
bain marie bailing bowl	492
baking mittens	498
baking pan	495
baking sheet	382
bar caddy	431
bar knife	425, 483
bar set	431
bar spoon	423
barbecue tong	474
barblade	432
barrel	415, 417
barrel enamel	257
basket	44, 333, 341
basket metal	20, 22, 23, 343, 346 347, 349
basket polypropylen	110, 154, 274 325-329, 332-338, 397
basket stainless steel	28, 29, 34, 35 341, 343-345
beer rack	86, 411, 448
bell	455
bento box	31-33
beverage dispenser	99, 105
bill presenter	89, 451
bill rail	500
bill spike	500
board	68, 91
bottle cooler	50, 51, 402, 405 408-410, 412
bottle opener	412
bottle rack	411
bowl	43, 122, 123, 131 132, 144, 503, 513, 514
bowl concrete	250, 251
bowl enamel	257, 259, 304
bowl holder	131, 132
bowl melamine	14-16, 18, 19, 22 25, 29-31, 34, 42, 49, 116, 118, 124, 131, 132, 166, 169, 170, 171 174-180, 182, 183, 185, 188, 189 195, 198, 199, 202-207, 209 211-217, 219, 220, 222-224 226-231, 233-235, 237-239, 243-245, 267, 345, 445, 510, 512, 513
bowl stainless steel	42, 49, 78, 94 111, 267, 343
box / sweetbox	148, 149
bread basket	340-342
bread box	146, 347
brush	499
buffet ladder	41, 122, 123
buffet ladder melamine	41
buffet set	40, 42, 43, 57, 133
buffet set refrigerated	48
buffet set refrigerated stainless steel	53, 140, 141
buffet showcase	134, 135, 145
buffet showcase stainless steel	136 137, 138, 139
buffet signs	286
buffet stand	20, 22, 23, 45, 53, 90 108-110, 118, 119, 124 126, 234, 335, 346, 347
buffet stand metal	27, 34, 35, 106-108

buffet stand stainless steel	28, 29, 31 34, 35, 108, 345
buffet stand wood	20, 24, 25, 107 108, 250, 251
burner holder stainless steel	375
butter and sauce pan warmer	373
butter curler	480
butter dish	304
C	
cake lifter	467, 470, 495
cake marker	496
cake mould	495
cake plate	64, 81, 92, 93 240, 264, 265, 266
cake setting ring	495
cake slice	470
candleholder	310-314
canele / decorating knife	478, 479
canister	149, 499
cap bowl	412, 432
carafe glass	95
card holder	280-286
caviar cooler	93, 266
cereal dispenser	50, 51, 125-128
cereal dispenser stainless steel	126
chafing dish	352-368, 372, 374
chafing dish rolltop	359-361, 364
champagne bowl	402-407, 437
cheese dish	299
cheese slicer	484
chefs blow torch	484
citrus squeezer	425, 427
citrus wedger	426
clingfilm tear-off-dispenser	501
cloche / dome cover	270
coaster natural slate	64, 287, 289
coaster stainless steel	89, 271, 451
coffee cup	247
coffee dispenser stainless steel	369, 371
coffee pot	444
concrete	152, 250, 251, 278 291, 396, 409
condiment container	499
condiment holder	431
confectionery funnel	491
container	104, 151, 155, 273, 393 395, 398, 399, 445
cool collar	410,411
cooler	39, 49, 53, 57, 104 134-144, 412, 514
cooling bowl	49, 93, 142-144, 266
cooling box	48, 53, 140, 140, 141
cooling carafe	95
cooling plate stainless steel	139
cooling tray	37, 45
cooling tray stainless steel	137
corer	481
corkscrew	433
cornet stand	501
cover	15, 25, 30, 78, 81, 93, 104 122, 123, 134, 136, 138, 140 142-144, 177, 182, 183, 185, 195 196, 218, 223, 227, 235, 240, 264 266, 334, 356, 358, 509-514
cover rolltop	25, 44, 57, 80, 133, 137 139, 141, 240, 333, 509, 510
cover rolltop stainless steel	368
cover stainless steel	356, 358
crumber	159, 279
cup melamine	177
curler	68
cutlery bag	321
cutlery basket	155, 279, 398
cutlery basket melamine	151, 395
cutlery bin	50, 51, 151-156, 158 159, 273, 274-276, 278 336, 337, 382, 394-398
cutlery rest	246, 389
cutting board	38, 57, 140, 146 147, 347, 425
cutting board rack	500
D	
dariol mould	375, 493
decorating knife	482
decorator / zester	479
designation cards	280, 283
dispenser	99, 443, 503
dispenser juice	50, 51, 54, 55 98-101, 103
dispenser juice / milk	54, 55, 98 99, 100
dispenser sugar	301-303, 440-442
display	82, 110, 316
display tray	496
divider	236, 325
door sign plate	515
dosing pump / riser tube	503
dough scraper	488
dressing pot melamine	94, 229
dressing pot stainless steel	94
drip mat	430
drip tray melamine	105, 431
dust & fly cap	438
E	
egg cutter	475
egg holder	247
eggs basket	341
eggs box	398
enamel	257-259, 304
etagère	17, 65, 111, 113-115 236, 344
F	
Feuerzangenbowle	372
fingerfood plate	239
fire tong	372
fish plate	91, 236
fish scaler	484
fork	389,467
fork meat	386, 387, 389, 463, 464 467, 468
fork salad	389, 466, 469
frame for induction plate	356-358, 370
free flow pourer	435, 436
fry dripping tray	490
garbage can	457
glass holder	438
glass plate	133
glass rack	411
glass rimmer	421
G	
GN basket	44, 334
GN basket metal	348, 349
GN basket polypropylen	44, 110, 120 121, 324, 327, 330, 331, 335
GN bowl melamine	13, 14, 180, 181 184, 219, 221
GN buffet ladder	120, 121
GN buffet set	38,75
GN buffet set refrigerated stainless steel	140
GN buffet showcase stainless steel	136,138
GN buffet stand	29, 34, 35, 46, 47 105, 335
GN chafing dish	352, 355, 356, 359
GN container	120, 121, 377 380, 381, 383-385
GN convection oven trays	229, 382
GN cover	39, 44, 53, 59, 68, 75 172, 324, 333, 334, 348, 349 378-381, 384, 508, 509, 512
GN cutlery bin	153, 330, 394
GN dish	69, 383
GN drainer	380
GN grid	382
GN natural slate tray	46, 47, 62, 63
GN partytray	82, 83
GN serving board	66
GN serving stand	117
GN tray	45, 69, 70, 71, 192, 383
GN tray melamine	20, 21, 28, 29, 32 34, 39, 45-47, 167, 168, 172, 173 182, 183, 189, 190, 192, 193, 195 200, 213, 218, 221, 223, 228, 229 239, 345, 390
GN tray stainless steel	39, 52, 58, 59 72-78, 140, 239, 390, 508
gourmet glasses	261
graduated jug	492
granite chips	375
grapefruit knife	482
greaseproof	66, 255
H	
heating unit	360, 369, 371
hot plate	370
hygienic cover	68, 115, 148
I	
ice ball former	419
ice box	44
ice bucket	404, 418
ice cream scoop	475
ice crusher	420, 421
ice scoop	421
icebox	419
induction plate	353, 354 356-358, 370
J	
jigger	428
juice dispenser	50, 51, 54, 55 98-101, 103
juice pitcher	96,97
julienne cutting knife	483
K	
key cord	438
knife rest	271
L	
labels	280
ladle	386-389, 461-465, 467
ladle sauce	470
large whisk	477
leaf bowl melamine	18, 19, 178, 179 201, 212, 232, 233
lemon slice squeezer	267, 445
lemonpress	426
limepress	426
liquid fuel	375
lobster cracker	475
M	
magnetic knife rack	500
mandolin	491
marker	96, 28
masher	477
mat cork	504
meat / vegetable platter	77
meat / vegetable platter stainless steel	58, 72
meat platter	90
melon baller	478
menage	228, 295-300
menu cover	285
milk / cream jug	443, 444
milk dispenser	102, 103
mill chili	290
mill pepper	289-291
mill salt	289-291
mixing glass	429
Moscow Mule	417
moulin / sieve	489
mousse mould	494
mousse ring	494
muddler	422
multi rack stainless steel	130, 131
multibox	150
mussel pot	272
mustard glass	297
N	
napkin holder	160
napkin holder melamine	160
napkin holder stainless steel	160, 161
napkin rings	271
natural slate tray	62-65, 115 263, 287
non slip mat	28
O	
orange peeler	479
oyster knife	481
P	
pan	90, 505
pan wrought-iron	504
paper towel holder	501
paring knife	482
partytray	82, 83
pasta plate melamine	227
pastry bag	497
pastry cutter	480
pedal bin	457
peeler	479
pipng tubes	497
pitcher	95-97, 429
pitcher juice	96,97
pizza cutter	480, 488
pizza dish	505
pizza peel	498
placemat	317-321
plain tubes	497
plate / cake plate melamine	240
plate / cake plate stainless steel	92, 265
plate enamel	258
plate melamine	31, 34, 167, 170 176, 178, 198, 199, 202, 208, 210 225, 240, 244, 247, 345
plate tray	270
porcelain	45, 69, 102, 353, 358, 383
pourer	300-302, 435, 436, 440, 441
pourer cleaning brush	435
pouring container	434
pretzel-/ sausage stand	68, 115
quiche mould	495
R	
refillable burner	375
roll / bun basket	326
roll dispenser stainless steel	148
rolltop set	57, 64, 133
S	
salad spinner	498
sandwich knife	487
sauce boat	268
saucer melamine	177
sauté pan	272
scoop	496
scoop chips	490
scoop ice	421, 474
scoop universal	474
scraper	487
service tower	129
serving board	66, 67
serving cup	252-255
serving dish	372, 373
serving spoon	246, 386-389, 461-468

servicing stand	31, 112-114, 116, 117 119, 124, 148, 300
servicing stand/rack	300
servicing trolley	392, 393
set measuring spoon	475
shaker	292-294, 416, 417, 439, 477
shaker pepper	294-296, 298, 442
shaker salt	294-296, 298, 442, 490
shaker spice	292
shape sorter	154, 236, 397
signs	281, 282, 513
skewer rack / skewer	272
skimmer	388, 461, 462, 465, 468, 490
slate	63-65, 114, 119, 148, 287
snackpresenter	145
snap mesh tea ball	267, 445
soup ladle	469
soup warmer	357, 363, 366-368
speeze bottle	300, 435
spice mill	289, 29
spider	490
spoon	389, 467, 476
spoon delicatessen	476
spoon gourmet	269
spoon party	210, 241, 242
spoon salad	246, 389, 466, 469
spoon spaghetti	388, 462, 465, 470
squeeze bottle	502, 503
stand wine / champagne bowl	404
star tubes	497
stopper	437
strainer	424, 425, 489, 491, 498
sugar bags box stainless steel	443
sugar dispenser	301-303, 440-442
sugar pot	303, 443
sugar-creamer-set	303, 442
Superbox	46, 47, 105
sushiboard melamine	168, 208, 238
swivel peeler	480, 483
system-counter	385
T	
table caddy	156, 275, 306, 307, 309
table numbers	281
table stand	281, 284-286
table waist bin	156-159, 275-278
teabox	150
terraine mould	493
thermo set	141
thermo tray	134, 135
Thermo-Box	391
Thermo-Box GN	390, 391
tong	420, 461, 471-474
tray	17, 25, 71, 78, 84-87, 326, 399 446-449, 496, 510
tray melamine	27, 34, 63, 86, 91, 114 116, 117, 146, 166-168, 174, 175 177, 182, 183, 186-189, 191, 194 196-201, 203, 208-211, 214, 217 218, 220, 224, 225, 238, 240, 245 289, 347, 448, 510
tray snack	88, 399, 450
tray stainless steel	52, 57, 74, 76-81 90, 116, 134, 135, 229, 264, 431
tray wood	24, 25, 27, 87, 88, 449, 450
turner	387, 388, 460, 462 464, 465, 468, 485-488
U	
universal jug	444, 492
V	
vacuum jug	162, 163
vacuum wine pump	438
vase	315
W	
waiter's corkscrew	433
warmer	374
warning sign	515

water dispenser	99, 105
Weck	64, 260-263, 287
whisk	477
wind light	312-314
wine / champagne stopper	437
wine bowl	402-404, 406, 407
wine pump stopper	438
winebottle stand	411
woodbox	146, 150, 305-309, 347

ESPAÑOL

artículos	pág.
A	
abre ostras	481
abridor	412, 432
acumulador de frío	39, 49, 53, 57, 104 134-144, 412, 514
adaptador	379
aro de tarta	495
aros anti-goteo melamina	105, 431
azucarero	301-303, 440, 441, 442, 443
B	
bajo plato	270
bandeja	17, 25, 71, 78, 86, 326, 448 496, 510
bandeja acero inoxidable	52, 57, 74 76-81, 90, 116, 134, 135, 229, 264 431
bandeja de pizarra natural	62-65, 115 263, 287
bandeja de vidrio	133
bandeja isotérmica	141
bandeja madera	24, 25, 27, 87, 88 449, 450
bandeja melamina	27, 34, 63, 86, 91 114, 116, 117, 146, 166-168, 174, 175 177, 182, 183, 186-189, 191, 194 196-201, 203, 208-211, 214, 217 218, 220, 224, 225, 238, 240, 245 289, 347, 448, 510
bandeja para cerveza	86, 411, 448
bandeja para servicio	84-87, 399 446-449
bandeja para sushi melamina	168, 208 238
bandeja party	82, 83
bandeja pastelera	382, 496
bandeja refrigerada	37, 45
bandeja refrigerada acero inoxidable	137, 139
bandeja snack	88, 399, 450
bandeja termo	134, 135
baño María	359-361, 368
barra magnética para cuchillos	500
batidor	477
bento box	31-33
bol refrigerado	49, 93, 142-144, 266
bolsa cubiertos	321
bomba de salsa, sola	503
bomba de vacío para vino	438
boquillas	497
boquillas estrella	497
boquillas lisas redondas	497
bote	149, 499
bote dosificador flexible	502, 503
bote vertedor universal	301, 302 440, 441
botella exprimible	300, 435
botella store & pour	434
brocha	499
C	
caballete de mesa	281, 286
caddy de mesa	156, 275, 306-309
cafetera	444
caja de bolsas de azúcar acero inoxidable	443
caja de madera	146, 150, 305-309, 347
caja de pan	146, 347
caja de té	150
caja dispensadora	148, 149
caja múltiple	150
caja para huevos	398
caja surtida	154, 236, 397
calentador de mantequilla y salsa	373
calienta platos	374
campana	25, 78, 81, 93, 134, 136, 138 140, 196, 218, 240, 264, 334, 509-511
campana esférica	270
campana rolltop	25, 44, 57, 80, 133 137, 139, 141, 240, 333, 509, 510
campana rolltop acero inoxidable	368
candelabro	310-314
carro de servicio	392, 393

cartelitos de designación	280, 283
cazo para baño maría	492
cazo recto bajo	272
cenicero	452-457
cesta	44, 333, 341
cesta acero inoxidable	28, 29, 34, 35 341, 343-345
cesta de huevos	341
cesta metal	20, 22, 23, 343 346, 347, 349
cesta para bollos	326
cesta para cubiertos	155, 279, 398
cesta para cubiertos melamina	151, 395
cesta polypropylen	110, 154, 274 325-329, 332-338, 397
chafing dish	352-368, 372, 374
chafing dish rolltop	359-361, 364
champañera	405, 406, 437
coctelera	416, 417
colador	424, 425, 489, 491, 498
combustible líquido	375
concreto	152, 250, 251, 278 291, 314, 396, 409
conjunto de bar	431
contenedor	151, 155, 273, 393, 395
corta huevos	475
corta pasta	488
cortador de cítricos	426
cortador de pastelería	480
cortador de pizza	480, 488
cuachara de servicio	389, 466
cubeta	398, 399
cubierta higiénica	68, 115, 148
cubitera	44, 419
cubitera clásica	404, 418
cubitera para cava	402-404, 406, 407
cubitera para vino	402-404, 406, 407
cubo de la basura	457
cuchara	389, 462, 467, 476
cuchara de espaguetis	388, 465, 470
cuchara de servicio	246, 386-389 461-468
cuchara gourmet	269, 476
cuchara para ensalade	246, 389 466, 469
cuchara para helado, ovalada	475
cuchara party	210, 241, 242
cucharas gourmet	269, 476
cucharilla de cóctel	423
cucharón	386-389, 461-467
cucharón de salsa	470
cucharón de sopa	469
cuchillo acanalador	482
cuchillo curvado	482
cuchillo de decoración	479
cuchillo de decoración cincelador	
acanalado	478, 479
cuchillo mondador	482
cuchillo para cóctel	425, 483
cuchillo para cortar juliana	483
cuchillo para pomelo	482
cuchillo para untar	487
cuenco	43, 122, 123, 131, 132, 144 503, 513, 514
cuenco acero inoxidable	42, 49, 78, 94 111, 267, 343
cuenco concreto	250, 251
cuenco esmalte	257, 259, 304
cuenco melamina	14-19, 22, 25, 29-31 34, 42, 49, 116, 118, 124, 131, 132 166, 169, 170, 171, 174-183, 185 188, 189, 195, 198-239, 243-245 267, 345, 445, 510-513
cuenco para chapas	412, 432
descorazonador	481
D	
dispensador	99, 443
dispensador de azúcar	303, 442
dispensador de bebidas	99, 105
dispensador de bocadillos	145
dispensador de café acero inoxidable	369, 371

dispensador de cereales	50, 51 125-128	GN cubeta para hornos de convección	229, 382	papel alimenticio	66, 255	soporte bufé	20, 22, 23, 45, 53, 90 109, 110, 118, 119, 124, 126, 335 346, 347
dispensador de cereales acero		GN cuenco melamina	13, 14, 180, 181 184, 219, 221	papelera de sobremesa	156-159 275-278	soporte bufé acero inoxidable	28, 29 31, 34, 35, 108, 345
inoxidable	126	GN dispensador en escalera	120, 121	pelador	479	soporte bufé madera	20, 24, 25, 107 108, 250, 251
dispensador de cubiertos	154, 274 337, 397	GN escurridor	380	pelador de espárragos	478	soporte de mesa	280-286
dispensador de especias	431	GN papa	380, 384	pelador de naranjas	479	soporte para bol	131, 132
dispensador de film	501	GN recipiente	120, 121, 377, 380-385	pelador reversible	480, 483	soporte para botellas	300
dispensador de leche	102, 103	GN recipiente para cubiertos	153, 330 394	pickadora de hielo	420, 421	soporte para brochetas / brochetas	272
dispensador de panecillos acero		GN rejilla	382	pictogramas	515	soporte para bufé	108, 234
inoxidable	148	GN set de bufé	38, 75	pie porta champañera / vino	404	soporte para bufé metal	27, 34, 35 106-108
dispensador de salsa	503	GN set de bufé refrigerado acero		pimentero	294-296, 298, 442	soporte para el quemador acero	
dispensador de zumo	50, 51, 54, 55 98, 99, 100, 101, 103	inoxidable	140	pinchanotas	500	inoxidable	375
dispensador de zumo o leche	54, 55 98-100	GN soporte bufé	29, 34, 35, 46, 47 105, 117, 335	pinza	420, 461, 471-474	soporte para embutidos	68, 115
dispensador en escalera	41, 122, 123	GN tabla de servir	66	pinza bogavante	475	soporte para quemada	372
dispensador en escalera acero		GN tapa	378, 379, 381	pinza exprimelímón	267, 445	soporte para tablas	500
inoxidable	130, 131	GN vitrina de bufé acero inoxidable		pizarra	63-65, 114, 119, 148, 287	soporte platos	119, 148
dispensador en escalera melamina	41	granulado térmico	375	placa caliente	370	soporte salsas y condimentos	300
divisor	236, 325	H		placa de inducción	353-358, 370	sujeta copas	438
embudo dosificador	491	huevera	247	plato de carne / veduras acero		Superbox	46, 47, 105
enfriador de botellas	50, 51, 402, 405 408-410, 412	I		inoxidable	58, 72	soporte para cornetos	501
enfriador de caviar	93, 266	indicadores	281, 282, 513	plato de carne / verduras	77	T	
escamador	484	indicadores bufé	286	plato esmalte	258	tabla de corte	38, 57, 140, 146, 147 347, 425
excavador	478	infusor de té, pinza con malla	267, 445	plato melamina	31, 34, 167, 170 176, 178, 198, 199, 202, 208, 210 225, 240, 244, 247, 345	tabla de servir	66, 67
escova de limpieza para rolhas		J		plato para el aperitivo	239	tabla para el bufé	68, 91
doseadoras	435	jarra	95-97, 429	plato para pasta melamina	227	tapa	15, 30, 93, 104, 122, 123 142-144, 177, 182-185, 195 223, 227, 235, 266, 356, 358 512-514
E		jarra de leche / creme	443	polvoreador	292-294, 439, 477	tapa de acero inoxidable	356, 358
escurrir verduras	498	jarra de refrigeración	95	porcelana	45, 69, 102, 353, 358, 383	tapa hermética	43, 49, 128, 513
escurridor de fritos	490	jarra de zumo	96, 97	porcionador de manzana / cebolla	484	tapete escurridor	430
esmalte	257-259, 304	jarra graduada	492	porcionador de pastel	470	tapón	437
espátula	387, 388, 460, 462, 464 465, 468, 485-488	jarra termo	162, 163	porta botellas	411	tapón antipolvo	438
espátula plancha	487	jarra universal	444, 492	porta rollo de cocina	501	tapones al vacío para el vino	438
especiero	499	jarra vidrio	95	porta tartas	64, 81, 92, 93, 240 264-266	tarros gourmet	261
espremedor de lima	426	jarritas para leche o crema	444	porta tartas acero inoxidable	92, 265	taza	415, 417
espumadera	388, 461, 462, 465, 468	juego de cucharas medidoras	475	porta tartas confitería	93, 266	taza de café	247
espumadera para fritos	490	L		porta tartas melamina	240	taza esmalte	257
esterilla	28	llavero enrollable	438	porta vela	312-314	taza melamina	177
esterilla escurridora	430	M		portafichas	500	tenedor de carne	386-389, 463, 464 467, 468
etiquetas	280	machacador	477	presentar cuenta	89, 451	tenedor de servicio	389, 467 466, 469
expositor	17, 31, 65, 82, 110 117, 124, 236, 316, 344	mandolina	491	Q		Thermo-Box	391
exprimidor cítricos	425, 427	manga pastelera	497	quemador recargable	375	Thermo-Box GN	390, 391
exprimidor de lima	426	manoplas de panadero	498	quesera parmesano	299	timbre	455
exprimidor de limón	426	mantelín	317-321	rack de copas	411	torre de servicio	129
F		mantequillera	304	rebanador de queso	484	V	
Feuerzangenbowle	372	marcador de pasteles	496	recipiente	104, 445	vaso mezclador vertedor	429
flanera	375, 493	marco para placa de inducción	356-358, 370	recipiente para cubiertos	50, 51 151-159, 273-278, 336, 337, 382 394-398	vaso mostaza	297
florero	315	marco pastelero	495	recogemigas	159, 279	vaso para servir	252-255
forjada	90	marmita de sopa	357, 363, 366-368	reposa cuchara	246, 389	vertedor	300, 435, 436
fuelle de servicio	372, 373	medidor jigger	428	reposa cuchillos	271	vertedore continuo	435, 436
fuelle en forma de hoja de palmera		mejillonera	272	resistencia	360, 369, 371	vitrina de bufé	134, 135, 145
melamina	232, 233	menage	228, 295, 296-300	ribeteador de vasos	421	vitrina de bufé acero	
fuelle en forma de hoja melamina	18 19, 178, 179, 201, 212, 232, 233	molde de cubitos de hielo esféricos	419	rizador	68	inoxidable	136-139
fuelle para pescado	91, 236	molde de pizza	505	rizador de mantequilla	480	W	
fuelle servicio	90	molde para emplatar	494	rotulador	96, 28	Weck	64, 260-263, 287
funda enfriadora	410, 411	molde para semifríos	494	S			
funda para cartas de menu	285	molde quiche	495	sacacorchos de camarero	433		
G		molde tarrina	493	salero	294-296, 298, 442, 490		
GN bandeja	45, 69, 70, 71, 192, 383	molde tarta	495	salsera	268		
GN bandeja acero inoxidable	39, 52 58, 59, 72-78, 140, 239, 390, 508	molinillo de chile	290	salsera acero inoxidable	94		
GN bandeja bufé	69, 383	molinillo de la especia	289-290	salsera melamina	94, 229		
GN bandeja de pizarra natural	46, 47 62, 63	molinillo de pimienta	289-291	salvamanteles	504		
GN bandeja melamina	20, 21, 28, 29 32, 34, 39, 45-47, 167, 168, 172, 173 182, 183, 189, 190, 192, 193, 195 200, 213, 218, 221, 223, 228, 229 239, 345, 390	molinillo de sal	289-291	sartén	505		
GN bandeja party	82, 83	molino de grosellas	489	sartén forjada	504		
GN campana	39, 44, 53, 59, 68, 75 172, 324, 333, 334, 348, 349, 508 509, 512	montaña acero inoxidable	89, 271, 451	señal de advertencia	515		
GN cesta	44, 334	montaña pizarra natural	64, 287, 289	servilletero	160, 271		
GN cesta metal	348, 349	mortero	422	servilletero acero inoxidable	160, 161		
GN cesta polypropylen	44, 110, 120 121, 324, 327, 330, 331, 335	Moscow Mule	417	servilletero melamina	160		
GN chafing dish	352, 355, 356, 359	N		set de bufé	40, 42, 43, 57, 133		
		números para mesa	281	set de bufé refrigerado	48		
		O		set de bufé refrigerado acero			
		organizador de bar	431	inoxidable	53, 140, 141		
		P		set para azúcar y leche	303, 442		
		pala	496	set rolltop	57, 64, 133		
		pala / bandeja para tarta	495	sistema para mostrador	385		
		pala hielo	421, 474	soplete de cocina para flambear	484		
		pala de pizza	498	soporte a pedal	457		
		pala de tartas	467, 47	soporte botellas vino	411		
		pala para patatas fritas	490				
		pala universal	474				
		panera	340-342				

item	pág.
A	
accumulateur de froid	39, 49, 53, 57 104, 134-144, 412, 514
adaptateur	379
anneaux à serviettes	271
anneaux coupe-gouttes mélamine	105, 431
ardoise	63-65, 114, 119, 148, 287
assiette mélamine	178
assiette à tarte	64, 81, 92, 93, 240 264-266
assiette à tarte acier inoxydable	92, 265
assiette à tarte mélamine	240
assiette creuse mélamine	227
assiette de présentation	270
assiette de viande / légume acier inoxydable	58, 72
assiette de viande / légumes	77
assiette émail	258
assiette mélamine	31, 34, 167, 170 176, 178, 198, 199, 202, 208, 210 225, 240, 244, 247, 345
assiette pour apéritif	239
B	
bac	398, 399
bain-marie	359-361, 368
barre aimantée pour couteaux	500
barre porte-bons	500
bento box	31-33
béton	152, 250, 251, 278 291, 314, 396, 409
beurrer	304
boîte à épices ou ingrédients	499
boîte à fruits et ingrédients	431
boîte à oeufs	398
boîte à pain	146, 347
boîte à thé	150
boîte de tri	154, 236, 397
boîte distributrice	148, 149
boîte en bois	146, 150, 305-309, 347
boîte multi	150
boîte sacs de sucre acier inoxydable	443
bol	43, 122, 123, 131, 132 144, 503, 513, 514
bol acier inoxydable	49
bol béton	250, 251
bol émail	257, 259, 304
bol mélamine	14-19, 22, 25, 29-31 34, 42, 49, 116, 118, 124, 131 132, 166, 169-185, 188, 189, 195 198-239, 243-245, 267, 345, 445 510, 512, 513
bol récupérateur de capsules	412, 432
bol réfrigéré	49, 93, 142-144, 266
bordeur à verres „rimmer“	421
bouchon	437
bouchon à vin / champagne	437
bouchon anti-poussières et anti-insectes	438
bouchon verseur	300, 435, 436
bouchon verseur continu	435, 436
bouchons à vide pour le vin	438
boule à thé avec pince	267, 445
bouteille store & pour	434
bouteille verseuse souple	502, 503
bowl inoxydable	42, 78, 94, 111 267, 343
brosse lave-bouchons doseurs	435
broyeur à glaçons	420, 421
brûleur acier inoxydable	375
brûleur rechargeable	375

C	
caddy de table	156, 275, 306-309
cadre support inox pour plaque induction	356-358, 370
cafetière	444
cafetière isotherme	162, 163
carafe de refroidissement	95
cartes de désignation	280, 283
casserole à moules	272
chandrier	452-457
cercle à gâteaux	495
cercle à mousse	494
chafing dish	352-368, 372, 374
chafing dish rolltop	359-361, 364
chalumeau de cuisine	484
chandelier	310-314
chariot de service	392, 393
chauffe-plat	374
chevalet de table	281, 286
chevalets	281, 282, 513
chevalets de buffet	286
cloche	25, 78, 81, 93, 134, 136 138, 140, 196, 218, 240 264, 334, 509-511
cloche demi-sphère	270
cloche rolltop	25, 44, 57, 80, 133 137, 139, 141, 240, 333, 509, 510
cloche rolltop acier inoxydable	368
combustible liquide	375
coquetier	247
coquille à beurre	480
corbeille	44, 333, 340, 341, 342
corbeille à petits pains	326
corbeille acier inoxydable	28, 29, 34 35, 341, 343-345
corbeille métal	20, 22, 23, 343, 346 347, 349
corbeille polypropylen	110, 154, 274 325-329, 332-338, 397
coupe-agrumes	426
coupe-oeufs	475
coupe-pâte	488
coupe-pizza	480, 488
coupe-pomme / -oignon en quartiers	484
couteau à huîtres	481
couteau à julienne	483
couteau à pamplemousse	482
couteau à tarte	470
couteau à tartiner	487
couteau cannelé	482
couteau cocktail	425, 483
couteau tranche-fromage	484
couteau zesteur	479
couteau zesteur cannelé	478, 479
couvercle	15, 30, 93, 104, 122, 123 142-144, 177, 182, 183, 185, 195 223, 227, 235, 266, 356, 358 512-514
couvercle acier inoxydable	356, 358
couvercle hermétique	43, 49, 128, 513
crémiers	444
cuillère	389, 467, 476
cuillère à cocktail	423
cuillère à glace ovale	475
cuillère à salade	246, 389, 466, 469
cuillère à sauce	470
cuillère à spaghettis	388, 462 465, 470
cuillère de service	246, 386-389, 461 462-468
cuillère gourmet	269, 476
cuillère party	210, 241, 242
cuillères gourmet	269, 476

D	
décapsuleur	412, 432
dérouleur de film	501
dérouleur papier essuie-tout	501
dessous-de-plat liège	504
disque à marquer les parts	496
distributeur	99
distributeur à jus	50, 51, 54, 55 98-103
distributeur à lait	102, 103
distributeur à lait ou jus	54, 55, 98-100
distributeur de boissons	99, 105
distributeur de café acier inoxydable	369, 371
distributeur de céréales	50, 51 125-128
distributeur de céréales acier inoxydable	126
distributeur de petits pains acier inoxydable	148
distributeur de sucre	303, 442
doseur à sauce	503
douilles	497
douilles en étoile	497
douilles lisses rondes	497
E	
écailleuse à poisson	484
écumoire	388, 461, 462, 465, 468
écumoire à friture	490
égouttoir à couverts	155, 279, 398
égouttoir à friture	490
égouttoir à mélamine	151, 395
émail	257-259, 304
entonnoir à piston	491
éplucheur droitier/gaucher	480, 483
essoreuse à salade	498
étiquettes	280
évideur	481
F	
Feuerzangenbowle	372
flacon pulvérisateur	300, 435
forme à gâteaux	495
fouet	477
fouet géant	477
fourchette à viande	386, 387, 389 463, 464, 467, 468
fourchette de service	389, 467
fourchette de service pour la salade	389, 466, 469
frisette	68
G	
gants de boulanger	498
GN bac pour fours à convection	229, 382
GN bol mélamine	13, 14, 180, 181 184, 219, 221
GN cesta polypropylen	324
GN chafing dish	352, 355, 356, 359
GN cloche	39, 44, 53, 59, 68, 75, 172 324, 333, 334, 348, 349 508, 509, 512
GN corbeille	44, 334
GN corbeille métal	348, 349
GN corbeille polypropylen	44, 110 120, 121, 327, 330, 331, 335
GN couvercle	378-381, 384
GN égouttoir	380
GN grille inox	382
GN planche de service	66
GN plat ardoise naturelle	46, 47 62, 63
GN plat buffet	69, 383
GN plateau	45, 69, 70, 71, 192, 383
GN plateau acier inoxydable	39, 52 58, 59, 72-78, 140, 239, 390, 508

GN plateau mélamine	20, 21, 28, 29 32, 34, 39, 45-47, 167, 168, 172 173, 182, 183, 189, 190, 192, 193 195, 200, 213, 218, 221, 223, 228 229, 239, 345, 390
GN plateau party	82, 83
GN présentoir buffet	29, 34, 35
GN présentoir buffet en escalier	120, 121
GN présentoir buffet froid acier inoxydable	140
GN présentoir pour le buffet	38, 75
GN récipient	120, 121, 377, 380, 381 383-385
GN récipients pour couverts	153, 330 394
GN support buffet	46, 47, 105 117, 335
GN vitrine de buffet acier inoxydable	136, 138
gobelet	415, 417
gobelet à apéritif	252-255
gobelet émail	257
gravier thermique	375
J	
jeu de cuillère à mesure	475
L	
lampe à bougie	312-314
louche	386-389, 461-465, 467
louche de service	469
M	
manchette rafraîchissante	410, 411
mandoline	491
marmite à soupe	357, 363, 366-368
marqueur	96, 28
ménage	228, 295-300
mesure double jigger	428
molde - terrina	493
montagnes russes acier inoxydable	89
	271, 451
montagnes russes ardoise naturelle	64 287, 289
Moscow Mule	417
moule à boule	478
moule à flan	375, 493
moule à glaçons en boules	419
moule à pizza	505
moule à quiche	495
moule à tarte	495
moulin à piment	290
moulin à poivre	289-291
moulin à sel	289-291
N	
numéros de table	281
O	
organisateur bar caddy	431
P	
panier à oeufs	341
panneau	515
papier alimentaire	66, 255
pare-haleine	68, 115, 148
paroi de séparation	236, 325
passoire	424, 425, 489, 491, 498
peleur	479
peleur à asperges	478
peleur à oranges	479
pelle / plateau à gâteau	495
pelle à farine	496
pelle à frites	490
pelle à gâteau	467, 47
pelle à glaçons	421
pelle à pizza	498
pelle glace	474
pelle multi-usages	474
pichet	95-97, 429
pichet à jus	96, 97

pichet à lait	443	porte-serviettes mélamine	160	support buffet acier inoxydable	28, 29
pichet en verre	95	porte-verre	438		31, 34, 35, 108, 345
pichet gradué	492	pose-cuillère	246, 389	support buffet bois	20, 24, 25, 107
pichet universel	444, 492	pot à sauce mélamine	94, 229		108, 250, 251
pictogrammes	515	pot à sauce acier inoxydable	94	support de table	280-286
pied pour seau à champagne / vin	404	pot en verre	149, 499	support des bouteilles	300
pilon	477	pot verseur universel	301, 302, 440	support multiple acier inoxydable	
pilon muddler	422		441		130, 131
pince	420, 461, 471-474	poubelle	457	support pour bols	131, 132
pince à barbecue	474	poubelle à pédale	457	support pour brochettes / brochettes	
pince à homard	475	poubelle de table	156-159, 275-278		272
pince presse citron	267, 445	présentoir	17, 31, 65, 82, 110-119	support pour sucre à flamber	372
pinceau pâtissier	499		124, 148, 236, 316, 344, 443	système-comptoir	385
pique-bons	500	présentoir buffet en escalier	41, 122	T	
planche à découper	38, 57, 140, 146		123	tableau bois	87, 449
	147, 347, 425	présentoir buffet en escalier		tapis	278
planche à découper buffet	68, 91	mélamine	41	tapis de bar	430
planche de service	66, 67	présentoir buffet froid	48	tapis égouttoir	430
plaque à induction	353-358, 370	présentoir buffet froid acier inoxydable		tasse à café	247
plaque à pâtisserie	382		53, 140, 141	tasse mélamine	177
plaque à pâtissière	496	présentoir pour le buffet	40, 42, 43	Thermo-Box	391
plaque chaude	370		57, 133	Thermo-Box GN	390, 391
plat à sauter	272	présentoire à sandwiches	145	tire-bouchons	433
plat ardoise naturelle	63, 64, 287	presse citron	425-427	tire-bouchons sommelier	433
plat creux à poisson	91, 236	presse limon	426	tour de service	129
plat creux de service	372, 373	presse-groseilles	489	V	
plat de service	90	protège-menu	285	vase	315
plateau	17, 25, 71, 78, 86, 326, 448	R		verre à moutarde	297
	496, 510	rack porte-verres	411	verre mélangeur	429
plateau acier inoxydable	78	rack pour planches à découper	500	verres gourmet	261
plateau à gâteaux	93, 266	rafraichisseur de caviar	93, 266	vitrine de buffet	134, 135, 145
plateau acier inoxydable	52, 57, 74-81	ramasse-miettes	159, 279	vitrine de buffet acier inoxydable	
	90, 116, 134, 135, 229, 264, 431	réchaud à beurre et sauce	373		136-139
plateau ardoise naturelle	62-65, 115	réipient	104, 151, 155, 273	W	
	263, 287		393, 395, 445	Weck	64, 260-263, 287
plateau avec sucrier et crémier	303, 442	réipient bain-marie	492		
plateau bois	24, 25, 27, 88, 450	réipients pour couverts	50, 51		
plateau buffet froid acier			151-159, 273-278		
inoxidable	139		336, 337, 382, 394-398		
plateau buffet froid inoxydable	137	refraichisseur de bouteille	50, 51, 402		
plateau de service	84-87, 399		405, 408-412		
	446-449	reposé-couteaux	271		
plateau feuille de palme mélamine		résistance	360, 369, 371		
	232, 233	roulette à pâte	480		
plateau feuille mélamine	18, 19, 178	S			
	179, 201, 212, 232, 233	salière	294-296, 298, 442, 490		
plateau mélamine	27, 34, 63, 86	saucière	268		
	91, 114-117, 146, 166-168, 174, 175	saupoudreuse à épices	292-294		
	177, 182, 183, 186-189, 191, 194		439, 477		
	196-201, 203, 208-211, 214, 217	seau à champagne	402-407, 437		
	218, 220, 224, 225, 238, 240, 245	seau à glaçons	44, 419		
	289, 347, 448, 510	seau à glaçons classique	404, 418		
plateau party	82, 83	seau à vin	402-407		
plateau réfrigéré	37, 45	service à parmesan	299		
plateau snack	88, 399, 450	set de table	317-321		
plateau sushi mélamine	168, 208, 238	set pour le bar	431		
plateau thermo	134, 135	set rolltop	57, 64, 133		
plateau verre	133	set thermo	141		
platillo mélamine	177	shaker	416, 417		
poche pâtissière	497	sonnette	455		
pochette couverts	321	spatule	387, 388, 460, 462		
poêle	505		464, 465, 468, 485-488		
poêle à frire forgée	90, 504	spatule coudée spéciale grill	487		
poivrière	294-296, 298, 442	sucrier	301-303, 440-443		
pompe à sauce	503	Superbox	46, 47, 105		
pompe à vide pour le vin	438	support à bretzel ou à saucissons			
porcelaine	45, 69, 102, 353, 358, 383		68, 115		
porte condiments et sauces	300	support à buffet métal	27, 34, 35		
porte verre à bière	86, 411, 448		106-108		
porte-bouteille vin	411	support à cornets	501		
porte-bouteilles	411	support buffet	20, 22, 23, 45, 53, 90		
porte-clés avec câble à enroulement			108-110, 118, 119, 124, 126, 234		
	438		335, 346, 347		
porte-serviettes	160				
porte-serviettes acier inoxydable					
	160, 161				

- DE** Wir behalten uns das Recht vor, die angegebenen Spezifikationen jederzeit zu ändern. Irrtum, Druckfehler und technische Änderungen vorbehalten. Artikelbeschreibungen sowie Abbildungen und Fotodarstellungen sind ohne Gewähr. Alle Angebote ohne Dekoration. Alle Preise verstehen sich in Euro zuzüglich der gesetzlichen Mehrwertsteuer.
© COPYRIGHT - Die Vervielfältigung dieses Kataloges - auch wenn partial - muss ausschließlich von der Assheuer + Pott GmbH & Co. KG genehmigt werden.
Bildnachweis Vorschaltseiten: Shutterstock
- GB** We reserve the right to alter at any time the specifications stated without notice. Errors, printing error and technical changes reserved. Item description as well as images and illustrations are without guaranty. All offers are without decoration. All prices are in Euro and exclude the legal VAT prescribed by law.
© COPYRIGHT - This catalogue may not be reproduced in whole or in part unless specific prior written authorization of Assheuer + Pott GmbH & Co. KG.
- ES** Nos reservamos el derecho de efectuar modificaciones en cualquier momento, sin aviso previo. Salvo errores de imprenta o impresión o cambios técnicos. La descripción de los artículos, sus imágenes e ilustraciones son sin garantía. Los artículos se ofrecen sin decoración. Todos los precios indicados son en euros y a dichos precios se deberán añadir el impuesto sobre el valor añadido legal vigente.
© COPYRIGHT - Todas las reproducciones, aunque parciales, de este catálogo tienen que ser autorizadas por escrito por Assheuer + Pott GmbH & Co. KG.
- FR** Nous nous réservons le droit de modifier à tout moment les spécifications. Toutes erreurs, fautes d'impression et modifications techniques sont réservées. Descriptions d'articles, des illustrations et des photo sont sans garantie. Toutes les articles s'entendent hors décoration. Tous les prix s'entendent en Euro et T. V. A. légale en vigueur non incluse.
© COPYRIGHT - toute reproduction même partielle de ce catalogue est interdite sauf autorisation expresse de Assheuer + Pott GmbH & Co. KG.



buffet | tabletop | bar

Assheuer + Pott GmbH & Co. KG

Talweg 11, 59846 Sundern, Germany
Telefon +49 (0) 29 33 / 97 35 - 0
Telefax +49 (0) 29 33 / 97 35 - 35 (Zentrale)
Telefax +49 (0) 29 33 / 97 35 - 34 (Export)
info@aps-germany.de

aps-germany.de

KATALOG NR 45
CATALOG NO 45
CATÁLOGO N° 45
CATALOGUE N° 45

